



City Research Online

City, University of London Institutional Repository

Citation: Phillips, J. P., Langford, R. M., Kyriacou, P. A. & Jones, D. P. (2006). Optical fibre catheter photoplethysmograph. *Measurement & Control*, 39(3), pp. 84-87. doi: 10.1177/002029400603900304

This is the accepted version of the paper.

This version of the publication may differ from the final published version.

Permanent repository link: <http://openaccess.city.ac.uk/14689/>

Link to published version: <http://dx.doi.org/10.1177/002029400603900304>

Copyright and reuse: City Research Online aims to make research outputs of City, University of London available to a wider audience. Copyright and Moral Rights remain with the author(s) and/or copyright holders. URLs from City Research Online may be freely distributed and linked to.

City Research Online:

<http://openaccess.city.ac.uk/>

publications@city.ac.uk

OPTICAL FIBRE CATHETER PHOTOPLETHYSMOGRAPH

J.P. Phillips¹, R.M. Langford¹, P.A. Kyriacou² and D.P. Jones³

¹Anaesthetic Laboratory, St. Bartholomew's Hospital, London, UK

²School of Engineering and Mathematical Sciences, City University, London, UK

³Medical Electronics & Physics, Department of Engineering, Queen Mary, University of London

Executive summary

A fibre optic system for monitoring arterial oxygen saturation of internal tissue sites utilising the principle of reflectance pulse oximetry is being developed. It was shown that it is possible to obtain a stable photoplethysmograph (PPG) signal from the fingertip using a twin optical fibre catheter. The results of experiments to optimise the detection of PPG signals using optical fibres are presented. Possible applications of this method include measuring SpO₂ in the oesophagus, trachea, large intestine, brain tissue and spinal cord.

Introduction

Arterial oxygen saturation (SpO_2) is defined as the ratio of the concentrations of oxygenated haemoglobin (oxyhaemoglobin) to total haemoglobin in the arterial blood and is expressed thus

$$SpO_2 = \frac{[HbO_2]}{[HbO_2] + [Hb]} \times 100\%$$

where $[HbO_2]$ and $[Hb]$ are the concentrations of oxyhaemoglobin and deoxyhaemoglobin respectively¹. SpO_2 is now a universally recognised indicator of problems in the delivery of oxygen to the tissue². The measurement of SpO_2 using the principle of reflectance pulse oximetry was first described by Mendelson and Ochs in 1988³. It was found that by mounting a probe directly onto the skin surface it is possible to measure oxygen saturation from the forehead or thigh. Their

reflectance probe consisted of red and infrared light emitting diodes (LEDs) mounted adjacent to a photodiode with several millimetres separating the sources and detector.

Kyriacou *et al.* developed a miniaturised reflectance pulse oximeter (diameter 6.6 mm) for use internally⁴. They demonstrated that a reflectance probe placed in the oesophagus during anaesthesia produced photoplethysmograph (PPG) traces of greater amplitude than could be detected from the finger. Oesophageal blood oxygen saturation (SpO_2) values showed good agreement with results from commercial finger pulse oximetry probes and co-oximetry. A further study in patients undergoing cardiac surgery showed that reliable SpO_2 readings could be obtained during periods when finger probes failed due to poor peripheral perfusion⁵.

Further miniaturisation is possible by coupling the light sources and photodetector to optical fibres. Optical fibres have the advantages for patient safety of complete electrical isolation and the minimisation of the risk of thermal injury to tissue.

Oximetry depends on the differential absorption of red and infrared light by oxy- and deoxy-haemoglobin. Pulse oximeters use the pulsatile component of the signal to determine the absorption solely due to the arterial blood. The oxygen saturation is then calculated using an empirical algorithm. The feasibility of SpO_2 measurements is thus dependent on the capability of the system to acquire stable good quality PPG signals. This paper describes experiments conducted to determine the factors influencing PPG measurement via optical fibres, and thus the accuracy of the SpO_2 values obtainable with an optical fibre catheter probe.

Materials and Methods

A single-wavelength system was constructed to record a PPG signal from the fingertip, comprising three main parts:

A. Probe: The probe consists of two parallel optical fibres with a core diameter of 500 μm and an outer cladding diameter of 730 μm . Step-index multimode fibres manufactured from hard-clad silica (HCS) are used (SpecTran Speciality Optics, Avon, CT, USA). Each fibre is terminated at one end with an SMA connector and the other end is cut and polished flat. The fibres are coated in a protective PVC jacket, which is stripped away over a length of 5 cm from the un-terminated end.

B. Instrumentation: This is housed in an aluminium box containing: a light source, an SMA mounted red (660 nm) LED (The Optoelectronic Manufacturing Corporation Ltd, Redruth, UK); a photodetector, an SMA mounted PIN photodiode (The Optoelectronic Manufacturing Corporation Ltd); a power supply (2 x 12V lead-acid batteries); and, a custom-made regulated 50 mA LED current source. The box also contains signal processing hardware, namely a transimpedance amplifier, a 2nd-order low-pass Butterworth filter (cut-off frequency 19.4 Hz) and a passive high-pass filter (cut-off frequency 0.34 Hz) to separate the signal into its ac PPG and dc PPG components.

C. Data acquisition system: The ac PPG and dc PPG signals were digitised by a 16-bit PCMCIA data acquisition card (DAQCard-AI-16XE-50, National Instruments, Austin, TX, USA). A Sony VAIO PCG-Z600HEK notebook computer running a LabVIEW (National Instruments) Virtual Instrument (VI) was used for signal processing and storage. The VI reads the two PPG signals at a rate of 100 samples per second, displays the PPG waveform and records both signals in a spreadsheet file. A block diagram of the system is shown in Figure 1. The 19.4 Hz cut-off frequency of the low-pass filter removes the risk of aliasing errors.

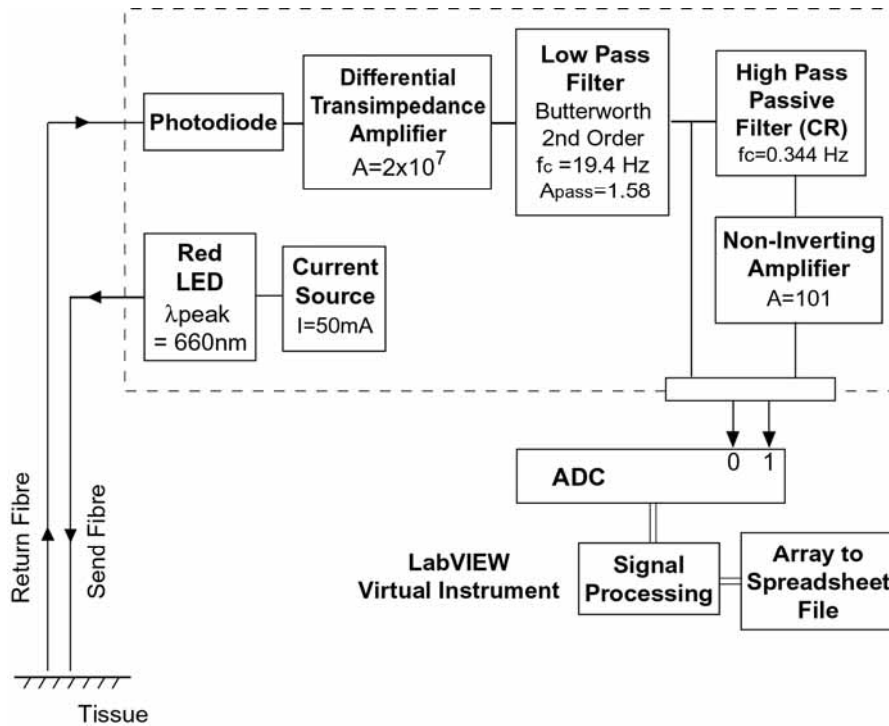

Figure 1: Block diagram of the system

Optical system: One fibre is coupled to the light source and transmits light to the tissue site. The other fibre returns the backscattered light from the tissue and is coupled to the photodetector. The distal ends of the fibres are mounted on the jaws of a pair of vernier callipers. The callipers are mounted on a firm optical bench assembly so that the axes of the fibres are maintained normal to the skin at the fingertip. The apparatus allows the lateral separation, s , of the fibre ends to be adjusted and set accurately using a thumbwheel on the callipers. A screw adjuster and vernier on the optical bench allows the distance, d , of the fibre ends from the skin surface to be set. The optical fibre arrangement is shown in Figure 2.

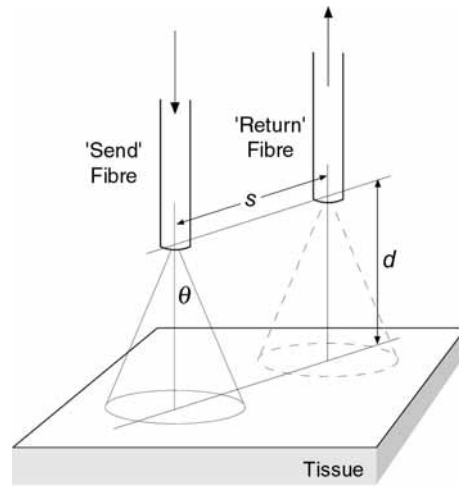

Figure 2: Optical fibre arrangement. The fibre-fibre separation s , tissue-fibre distance d , and acceptance angle θ are shown

Measurements: The apparatus was placed in a room with no direct sun or artificial light. Measurements were taken from the skin of the left forefinger of one subject. Prior to making any measurements a skin temperature probe (DeRoyal Inc., Powell, TN, USA) was affixed to the forefinger with tape as close to the measuring site as possible. The skin temperature was maintained between 31°C and 33°C during the measurements by adjusting the ambient air temperature using a thermostatically controlled fan heater. The fibre-fibre separation and tissue-fibre separations were set (in randomised order) and a continuous PPG signal was recorded for 10 minutes (approximately 600 heart beats). During this period the finger was held as still as possible by the subject. For the fibre-fibre separation study, the distance between the fibres and the skin was 0.5 mm. For the tissue-fibre distance measurements, a fibre-fibre separation of 2 mm was used.

Calculation of PPG Amplitude Ratios: The amplitude of the PPG waveform was calculated using a peak detection algorithm incorporated into a VI. The VI measures the peak-to-peak amplitude (Figure 3) of each pulse, calculates the ratio between this ac PPG amplitude and the dc PPG amplitude i.e. the total photodiode output, and produces an array of *PPG Amplitude Ratios (R)* which is saved as a spreadsheet file. Consider a PPG trace consisting of n pulses. The signal

voltage at each peak is denoted as V_{H1} , V_{H2} etc. and at each valley as V_{L1} , V_{L2} etc.

The array of PPG Amplitude Ratios is therefore $R_1=(V_{H1}-V_{L1})/V_{H1}$, $R_2=(V_{H2}-V_{L2})/ V_{H2}$..etc. where V_{H1} , V_{H2} etc. represent the dc PPG or total photodiode output. This PPG Amplitude Ratio R , was studied because it is essential for the empirical algorithm utilised for the calculation of SpO_2 . The mean of the PPG Amplitude Ratios is thus defined as:

$$\mu_A = (1/n)\Sigma (R_n)$$

Samples differing from the mean value by more than 3 standard deviations were deleted from the array.

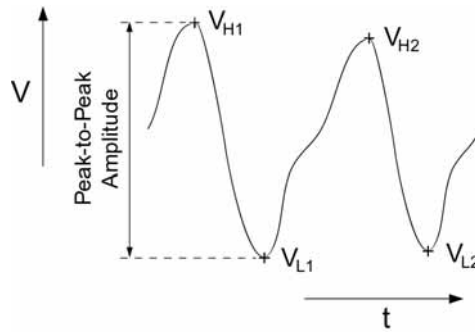

Figure 3: PPG amplitude is determined by identifying peaks and valleys as indicated by (+). The PPG Amplitude Ratio of peak n is defined as $R_n = (V_{Hn} - V_{Ln}) / V_{Hn}$.

Beat-to-beat variation: The coefficient of variation of the PPG Amplitude Ratio, $CV(R)$, was also calculated using the following expression:

$$CV(R) = (\sigma_A / \mu_A) \times 100\%$$

where σ_A is the standard deviation of the PPG Amplitude Ratio R .

Results

Effect of varying fibre-fibre separation: Figure 4 shows the result of dividing the output from the high-pass filter, corresponding to the ac PPG, by the output from the low-pass filter, corresponding to the dc PPG. It can be seen that the ac PPG component of the signal is very small ($<1.5\%$) compared with the dc PPG. The latter is, therefore, a good approximation to the total photodiode output. Furthermore, the ac PPG amplitude, relative to the dc PPG signal, is larger at the larger fibre-fibre separation. In addition, the PPG signal is better defined, more consistent in amplitude and less noisy.

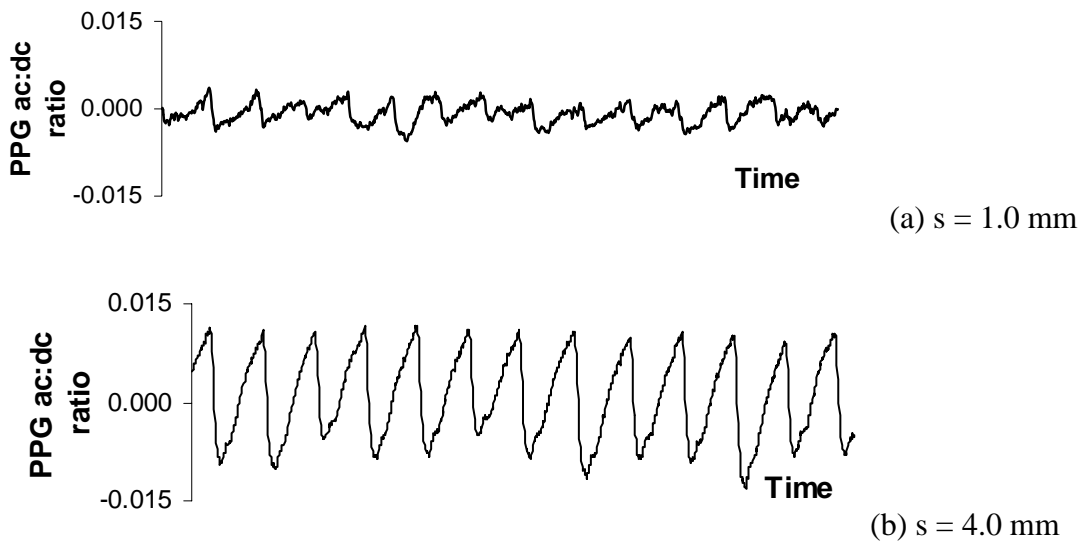

Figure 4: Short samples of ac PPG waveform traces divided by the dc PPG obtained from the forefinger at two different fibre-fibre separations, s

The PPG Amplitude Ratio R , as defined above, is plotted against separation distance, s , in Figure 5.

The value of the Ratio R increases as the fibre-fibre separation increases.

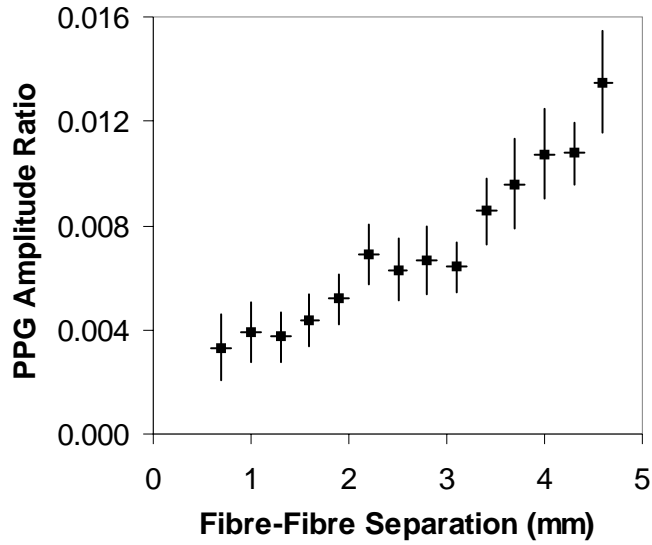

Figure 5: Effect of the fibre-fibre separation s on the PPG Amplitude Ratio R for a constant fibre-tissue distance $d = 0.5$ mm

The change in beat-to-beat variation is illustrated in Figure 6. The $CV(R)$ is fairly constant at larger separations but rises significantly when the fibres are brought closer together. Figures 5 and 6 serve as a quantitative representation of the deterioration in quality observed in the PPG signals and the PPG Amplitude Ratio R (see Figure 4) when the fibre-fibre separation is reduced.

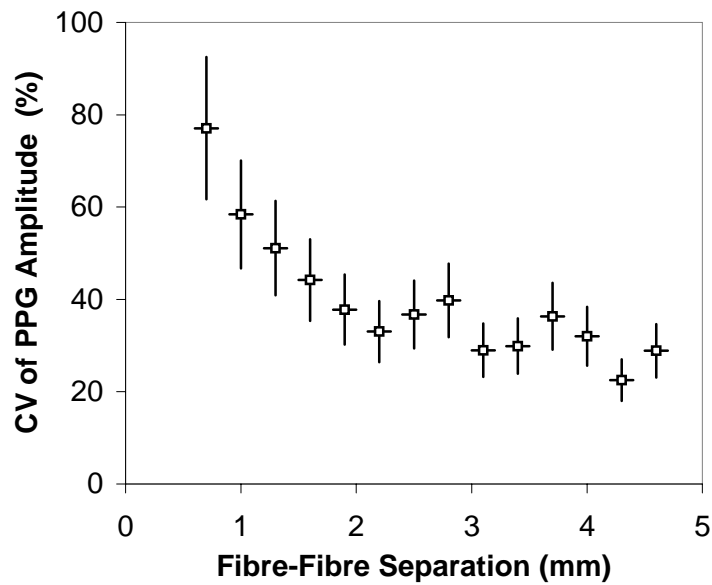
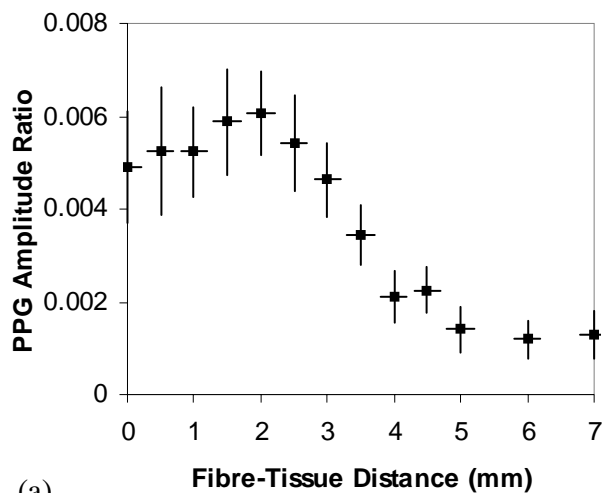
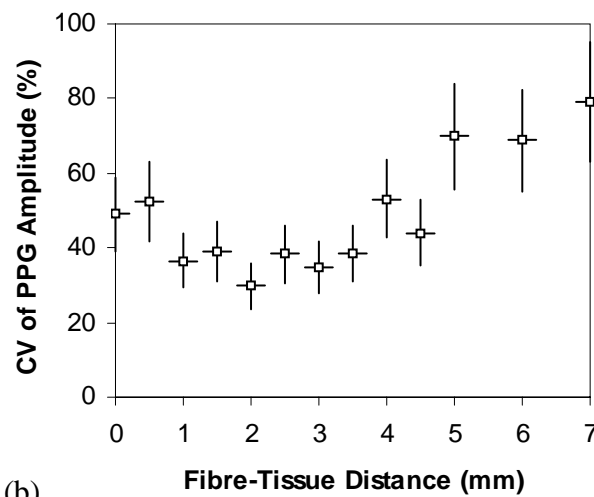

Figure 6: Effect of the fibre-fibre separation s on the co-efficient of variation of the PPG Amplitude Ratio for a fibre-tissue distance $d = 0.5$ mm.

Effect of varying fibre-tissue distance: Figure 7(a) shows how the PPG Amplitude Ratio changes as the distance between the fibre ends and the tissue surface is varied. The ac PPG signal is relatively strong when the fibres are close to the tissue surface. The PPG Amplitude Ratio tends to increase by a small amount as the distance is increased to 2 mm. When the fibres are moved more than 2 mm from the tissue there is a marked decrease in the PPG Amplitude Ratio R .



(a)



(b)

Figure 7: The effect of varying the distance d between the fibre ends and the tissue surface on (a) the PPG Amplitude Ratio and (b) the coefficient of variation of the PPG Amplitude Ratio. The fibre-fibre separation s was 2 mm.

The change in beat-to-beat amplitude variation $CV(R)$ is illustrated in Figure 7(b). The two plots in Figure 7 show that the most stable PPG signal occurs when the fibre-tissue distance is approximately 2 mm.

Discussion

The exact behaviour of light after entering an inhomogeneous scattering/absorbing material is not fully understood². As tissue is a highly scattering medium, photons arriving at the distal end of the 'return' fibre could have taken one of many paths through the scattering medium. In a reflectance oximetry system, the light path increases significantly as the separation between the light source and an adjacent sensor on the skin is increased⁶.

The arterioles and capillaries do not extend up to the skin surface. At larger fibre-fibre separations the light should penetrate the tissue to a greater depth and pass through a larger volume of pulsatile tissue than at smaller separations. In these circumstances, the light incident on the detector would be expected to be modulated to a greater degree by the pulsation of the tissue bed. This may explain the increase in ac to dc PPG Amplitude Ratio with increasing fibre-fibre separation seen in Figure 5.

Although the intensity of the source remains constant, as the fibre-fibre separation distance decreases, the total intensity of the light arriving at the detector (i.e. the dc PPG) becomes very large. The magnitude of the detected fluctuations in the signals is also found to increase, hence the observed increase in beat-to-beat amplitude variation with decreasing fibre-fibre separation, see Figure 6. These findings are similar to those of Mendelson and Ochs³, however they only investigated source-detector separation distances above 4 mm and used sources and detectors in direct contact with the skin. There appear to be no previous reports of such measurements using optical fibres.

Conclusion

It has been shown that it is possible to obtain a stable PPG trace from a finger using a fibre optic catheter probe, and that at larger fibre-fibre separations, the PPG signal quality is superior to that obtained at very small separations. In order to calculate SpO_2 accurately, there is a need to minimise variations in the detected PPG amplitude. Clearly the benefits in measured accuracy gained from increasing the separation between the fibres must be weighed against the disadvantages of using a catheter with a larger overall diameter.

Measurement of SpO_2 also requires the detection of PPG signals using infrared light which has a lower scattering coefficient in tissue⁷. Hence, both red and infrared PPG signal acquisition, enabling SpO_2 calculation, should be possible. These preliminary findings warrant further investigations to develop an optical fibre catheter pulse oximeter for use at internal tissue sites.

References

1. Moyle, J.T.B., *Pulse Oximetry*, London: BMJ Books, 2002.
2. Webster, J.G., *Design of Pulse Oximeters*, London: Institute of Physics Publishing, 1997.
3. Mendelson, Y. and Ochs B., *IEEE Transactions on Biomedical Engineering*, **35**, 798-805, 1988.
4. Kyriacou P., Powell S., Langford R. and Jones D., *IEEE Transactions on Biomedical Engineering*, **49**, 1360-8, 2002.
5. Kyriacou P., Powell S., Langford R. and Jones D., *Anaesthesia*, **58**, 422-427, 2003.
6. Liu Y., Zhu J. and Luo Y., *Proceedings of SPIE - the International society for Optical*

Engineering, **4916**, 98-102, 2002.

7. Schmitt J., *IEEE Transactions on Biomedical Engineering*, **38**, 1194-203, 1991.