



## City Research Online

### City, University of London Institutional Repository

---

**Citation:** Aristopoulos, M. (2017). A portfolio of recombinant compositions for the videogame Apotheon. (Unpublished Doctoral thesis, City, University of London)

This is the accepted version of the paper.

This version of the publication may differ from the final published version.

---

**Permanent repository link:** <https://openaccess.city.ac.uk/id/eprint/19298/>

**Link to published version:**

**Copyright:** City Research Online aims to make research outputs of City, University of London available to a wider audience. Copyright and Moral Rights remain with the author(s) and/or copyright holders. URLs from City Research Online may be freely distributed and linked to.

**Reuse:** Copies of full items can be used for personal research or study, educational, or not-for-profit purposes without prior permission or charge. Provided that the authors, title and full bibliographic details are credited, a hyperlink and/or URL is given for the original metadata page and the content is not changed in any way.

# **A portfolio of recombinant compositions for the videogame *Apotheon***

By  
**Marios Aristopoulos, student number: 100038079**  
Ph.D. thesis  
Word count: 43.621 & 68 minutes of original music  
Department of Music  
City, University of London  
September 2017

Supervisor: Dr. Miguel Mera

# TABLE OF CONTENTS

<b>ACKNOWLEDGEMENTS .....</b>	<b>6</b>
<b>ABSTRACT .....</b>	<b>7</b>
<b>INTRODUCTION .....</b>	<b>8</b>
<b>RESEARCH QUESTIONS &amp; METHODOLOGY .....</b>	<b>10</b>
<b>LIST OF PORTFOLIO COMPOSITIONS .....</b>	<b>13</b>
<b>CHAPTER 1: THE PROBLEM OF MUSICAL REPETITION IN GAMES .....</b>	<b>16</b>
1.1 REPETITION IN MUSIC .....	16
1.2 MUSICAL REPETITION IN OPEN WORLD GAMES & WORLD OF WARCRAFT .....	23
<i>World of Warcraft player survey</i> .....	26
1.3 TECHNIQUES FOR REDUCING REPETITION IN MMORPGS .....	30
<i>Use of Silence</i> .....	30
<i>Writing more original music</i> .....	31
<i>Custom Playlists</i> .....	33
CHAPTER 1 SUMMARY .....	35
<b>CHAPTER 2: INTRODUCING VARIABILITY THROUGH RECOMBINANT TECHNIQUES.....</b>	<b>36</b>
2.1 NON-STOCHASTIC RECOMBINANT ALGORITHMS .....	36
2.2 EARLY EXAMPLES OF ALEATORIC MUSIC .....	38
<i>Musikalisches Würfelspiel</i> .....	39
2.3 ALEATORIC TECHNIQUES IN THE 20 <sup>TH</sup> CENTURY .....	43
<i>Open form &amp; Mobile form</i> .....	44
2.4 ALEATORIC METHODS AND GAME MUSIC .....	46
CHAPTER 2 SUMMARY .....	51
<b>CHAPTER 3: CASE STUDIES: GAMES THAT USED STOCHASTIC RECOMBINANT ALGORITHMS IN THEIR MUSIC.....</b>	<b>52</b>
3.1 BALLBLAZER .....	52
3.2 TIMES OF LORE .....	54
3.3 LEGEND OF ZELDA: OCARINA OF TIME .....	55
3.4 TOMB RAIDER: LEGEND.....	57
3.5 RED DEAD REDEMPTION.....	60
3.6 LIMITATIONS OF THE STOCHASTIC RECOMBINANT ALGORITHMS USED IN THE CASE STUDIES.....	62
3.7 WHY HAVE STOCHASTIC RECOMBINANT ALGORITHMS NOT BEEN USED IN OTHER GAMES? .....	63
CHAPTER 3 SUMMARY .....	65
<b>CHAPTER 4: DEVELOPING AN EFFECTIVE STOCHASTIC RECOMBINANT ALGORITHM.....</b>	<b>66</b>
4.1 RECOMBINANT MODELS BY AXEL BERNDT ET AL. ....	66
4.2 RECOMBINANT MODELS BY RAYBOULD AND STEVENS.....	69
CHAPTER 4 SUMMARY .....	74
<b>CHAPTER 5: <i>APOTHEON</i>.....</b>	<b>75</b>
5.1 WHAT IS <i>APOTHEON</i> ? .....	75
5.2 ADVANTAGES OF USING <i>APOTHEON</i> AS A RESEARCH PROJECT. ....	79
5.3 PRAISE FOR THE <i>APOTHEON</i> SOUNDTRACK.....	81
5.4 EXAMINER GUIDELINES ON ACCESSING THE GAME USING A PC .....	83
5.5 MOTIVATION FOR USING A RECOMBINANT CELLS ENGINE IN <i>APOTHEON</i> .....	85
5.6 THE MUSICAL LANGUAGE OF <i>APOTHEON</i> .....	89
5.7 INFLUENCES FROM ANCIENT GREEK MUSIC .....	90
<i>Instrumentation</i> .....	91
<i>Performance and Production</i> .....	92
<i>Metre</i> .....	93
<i>Scales</i> .....	94
5.8 INFLUENCES FROM VIDEO GAMES AND FILMS WITH ANCIENT GREEK MUSIC .....	95
CHAPTER 5 SUMMARY .....	99
<b>CHAPTER 6: THROUGH-COMPOSED PIECES IN <i>APOTHEON</i> .....</b>	<b>100</b>
6.1 <i>KING OF THE GODS</i> .....	100

6.2 MARCH FROM HADES .....	103
6.3 APOLLO'S PALACE .....	103
6.4 ACHILLES HEEL .....	106
6.5 STREET MUSICIANS .....	106
6.6 DEFEAT/STALEMATE/VICTORY .....	108
6.7 TEN YEARS OF WAR/ TROJAN SHORES .....	110
6.8 MAZE OF ATHENA .....	113
CHAPTER 6 SUMMARY .....	115
<b>CHAPTER 7: RECOMBINANT TECHNIQUES IN APOTHEON.....</b>	<b>116</b>
7.1 INTRO & AIMS OF THE CHAPTER .....	116
7.2 THE VILLAGE: CREATING THE FIRST VERSION OF THE STOCHASTIC RECOMBINANT ENGINE .....	117
<i>Evaluation of the first experiment.</i> .....	120
7.3 THE VILLAGE VERSION 2: DEVELOPING THE STOCHASTIC RECOMBINANT ENGINE FURTHER .....	121
<i>Evaluation of the second experiment</i> .....	125
7.4 THE VILLAGE VERSION 3: THE FINAL ENGINE IMPLEMENTED IN THE GAME .....	127
<i>Evaluation of the final engine for The Village of Dion</i> .....	131
7.5 RECOMBINANT TECHNIQUES IN THE FOREST LEVEL .....	134
<i>In the Forests of Olympus - Vertical Layering</i> .....	134
<i>The battle with Artemis – Parallel Composition</i> .....	137
<i>The Caves level: asynchronous recombinant cells</i> .....	139
7.6 RECOMBINANT CELLS IN THE HADES UNDERWORLD LEVEL .....	142
<i>Hades general area</i> .....	145
<i>Lethe</i> .....	146
<i>Phlegedon</i> .....	147
<i>Acheron/Cocytus</i> .....	147
7.7 HORIZONTAL RESEQUENCING IN BATTLE MUSIC .....	148
<i>For Helen Part I, II, III</i> .....	148
<i>Ares – God of War</i> .....	150
7.8 RECOMBINANT COMPOSITIONS THAT WERE IMPLEMENTED LINEARLY .....	151
<i>Atlantis</i> .....	151
<i>Road to Troy</i> .....	154
CHAPTER 7 SUMMARY .....	158
<b>CHAPTER 8: CONCLUSION .....</b>	<b>160</b>
8.1 LIMITATIONS OF THE RECOMBINANT TECHNIQUES IN APOTHEON.....	160
<i>Musical direction</i> .....	160
<i>Musical Contrast</i> .....	163
8.2 FUTURE DIRECTIONS .....	165
<i>Markov Chains</i> .....	166
<i>Micro Cells</i> .....	170
8.3 CONTRIBUTION TO KNOWLEDGE .....	172
8.4 FINAL WORDS .....	178
<b>APPENDIX A: GLOSSARY OF VIDEOGAME TERMS .....</b>	<b>180</b>
<b>APPENDIX B: WORLD OF WARCRAFT SURVEY .....</b>	<b>183</b>
<b>APPENDIX C: APOLLO'S PALACE TRANSCRIPTION .....</b>	<b>186</b>
<b>APPENDIX D: OCCURRENCE PROBABILITY TABLES FOR THE VILLAGE OF DION FINAL ENGINE.....</b>	<b>190</b>
<b>APPENDIX E: CONTENTS OF THE ACCOMPANYING USB.....</b>	<b>193</b>
<b>WORKS CITED .....</b>	<b>196</b>



## LIST OF FIGURES

FIGURE 0.1: LIST OF PORTFOLIO TRACKS AS THEY APPEAR IN THE COMMERCIAL RELEASE OF THE <i>APOTHEON</i> OST	14
FIGURE 0.2: LIST OF PORTFOLIO TRACKS NOT INCLUDED IN THE OST BUT INCLUDED IN THE GAME	15
FIGURE 1.1: THE WUNDT CURVE OUTLINES THE RELATIONSHIP BETWEEN STIMULUS NOVELTY AND ENJOYMENT (HEDONIC VALUE) OVER TIME.	20
FIGURE 1.2: AVERAGE PLAYER VISITS PER ZONE IN <i>WORLD OF WARCRAFT</i>	25
FIGURE 1.3: GENRES OF MUSIC LISTENED TO BY GAMERS WHILE PLAYING <i>WORLD OF WARCRAFT</i>	29
FIGURE 2.1: THE ACCOMPANYING MATRIX FOR THE FIRST PHRASE FROM DICE GAME K516F ATTRIBUTED TO WOLFGANG AMADEUS MOZART.	41
FIGURE 2.2: SIMPLIFIED <i>COBRA</i> PERFORMANCE INSTRUCTIONS BASED ON THE <i>PORTLAND RULES</i> .	48
FIGURE 2.3: TRANSITION MATRIX IN <i>WWISE</i>	49
FIGURE 3.1: A SCAN OF THE ORIGINAL CARTRIDGE OF THE GAME FOR THE <i>ATARI 5200</i> CONSOLE.	52
FIGURE 3.2: A SCAN OF THE ORIGINAL GAME COVER FOR THE CONSOLE <i>ZX SPECTRUM</i> .	55
FIGURE 3.3: <i>LEGEND OF ZELDA: OCARINA OF TIME</i> GAME MAP SHOWING THE CENTRAL POSITION OF <i>HYRULE FIELD</i> .	56
FIGURE 3.4: THE STARTING SCREEN OF THE GAME IN THE CONSOLE <i>PSP</i> .	57
FIGURE 3.5: THE LARGE OPEN WORLD OF THE GAME SET IN THE AMERICAN WEST.	61
FIGURE 4.1: A PARALLEL AND SEQUENTIAL SEGMENTATION OF A HOLISTIC SCORE	67
FIGURE 4.2: THE SIMPLEST FORM OF A RECOMBINANT CELLS SYSTEM IMPLEMENTED IN THE FIRST VERSION OF <i>APOTHEON'S VILLAGE OF DION</i> .	69
FIGURE 4.3: STEVENS-RAYBOULD GRAPH OF THEIR RECOMBINANT SYSTEM.	70
FIGURE 4.4: STEVENS-RAYBOULD UDK BLUEPRINT REALIZATION USING A SOUND EVENT.	71
FIGURE 4.5: A BLUEPRINT IN UE4 INSPIRED BY STEVENS AND RAYBOULD'S "META CONTROLS" RECOMBINANT MODEL.	73
FIGURE 5.1: ANCIENT GREEK POTTERY: ACHILLES AND PENTHESILEA, PAINTED BY EXEKIAS, CIRCA 540-30 B.C.	76
FIGURE 5.2: TWO IN-GAME SCREENSHOTS FROM <i>APOTHEON'S APOLLO'S PALACE</i> DESIGNED BY JESSE MCGIBNEY	77
FIGURE 5.3: A GAMEPLAY SCREENSHOT FROM <i>ALIEN TRAP'S</i> FIRST 2D PLATFORM GAME <i>CAPSIZED</i> .	80
FIGURE 5.4: THE 15 BEST VIDEO GAME SOUNDTRACKS OF 2015 ACCORDING TO FACT MAGAZINE.	82
FIGURE 5.5: PHOTO OF THE FIRST PAGE AND INTERVIEW PAGE OF THE GREEK NEWSPAPER <i>TA NEA</i>	83
FIGURE 5.6: A PRINTED MAP OF THE MAIN LOCATIONS IN THE GAME TAKEN FROM THE COLLECTOR'S EDITION BOX SET.	86
FIGURE 5.7: A DEVELOPER'S MAP REPRESENTING POSSIBLE CONNECTIONS BETWEEN LEVELS IN <i>APOTHEON</i> . A HIGH RESOLUTION IMAGE OF THIS MAP CAN BE FOUND IN THE SUPPORTING MATERIAL OF THE THESIS.	88
FIGURE 5.8: SOME OF THE INSTRUMENTAL ASSOCIATIONS MADE IN <i>APOTHEON</i> .	92
FIGURE 5.9: M.L. WEST'S RHYTHMICAL ANALYSIS OF THE STROPHE OF PINDAR'S <i>FIRST PYTHIAN ODE</i> .	94
FIGURE 5.10: A SCENE FROM THE MOVIE <i>JASON AND THE ARGONAUTS</i> . A SIMILAR THEME OF THE HERO FIGHTING AGAINST A MYTHOLOGICAL SKELETON ARMY OCCURS IN THE <i>HADES</i> LEVEL IN <i>APOTHEON</i> .	97
FIGURE 6.2: THE TEXT SUNG BY THE CHOIR IN <i>KING OF THE GODS</i> , WRITTEN IN SEPARATE SYLLABLES USING <i>WORDBUILDER</i>	102
FIGURE 6.3: GAMEPLAY SCREENSHOT FROM THE BATTLE BETWEEN <i>NIKANDREOS</i> AND THE CYCLOPS <i>BRONTES</i>	104
FIGURE 6.4: THE MAIN THEME OF <i>APOLLO'S PALACE</i> WRITTEN IN CONCERT PITCH. THE FULL SCORE CAN BE FOUND IN APPENDIX C	105
FIGURE 6.5: <i>DEFEAT</i> CHORD PROGRESSION	110
FIGURE 6.6: A 2 <sup>ND</sup> CENTURY CYBELE PRIEST WITH THE INSTRUMENTS ASSOCIATED WITH HER CULT, CYMBALA (UPPER LEFT), TYMPANUM (UPPER RIGHT), AND PHRYGIAN AULOS (MIDDLE RIGHT).	111
FIGURE 6.7: THE OPENING FOUR BARS OF BERNARD HERMANN'S MAIN THEME FROM <i>VERTIGO</i> .	113
FIGURE 7.1: ARRANGEMENT OF THE CELLS BY INSTRUMENT IN <i>PRO TOOLS</i>	119
FIGURE 7.2: PLACEMENT OF EACH CELL IN FIVE DIFFERENT GROUPS/LAYERS ACCORDING TO FUNCTION RATHER THAN INSTRUMENTATION.	120
FIGURE 7.3: BY USING SILENCE AS A CELL PROBABILITY THE NUMBER OF LAYERS IS VARIED IN THE ARRANGEMENT.	122
FIGURE 7.4: CELL OCCURRENCE PROBABILITIES IN THE SECOND ENGINE OF <i>VILLAGE OF DION</i> .	126
FIGURE 7.5: 2D MAP OF <i>THE VILLAGE</i> LEVEL IN VERSION 3 SHOWING THE LOCATION IN WHICH DIFFERENT CELLS ARE INCLUDED IN THE SELECTION POOL.	128
FIGURE 7.6: OCCURRENCE PROBABILITIES TABLES FOR SOME OF THE QUESTS IN "THE VILLAGE" AREA. A FULL TABLE CAN BE FOUND IN APPENDIX D.	129

FIGURE 7.7: FLOW CHART FOR <i>THE VILLAGE OF DION</i> MAP.....	130
FIGURE 7.8 COMPARATIVE CHART OF THE THREE RECOMBINANT ENGINES DEVELOPED AND TESTED FOR THE <i>VILLAGE OF DION</i> . .....	133
FIGURE 7.9: A GAMEPLAY SCREENSHOT FROM <i>THE FOREST</i> LEVEL.....	134
FIGURE 7.10: FLOW CHART OF <i>THE FOREST</i> LEVEL.....	136
FIGURE 7.11: BATTLE WITH ARTEMIS FLOWCHART.....	138
FIGURE 7.12: <i>THE CAVES</i> GAMEPLAY SCREENSHOT. ....	139
FIGURE 7.13: <i>THE CAVES</i> ASYNCHRONOUS CELLS FLOWCHART. ....	141
FIGURE 7.14: GAMEPLAY SCREENSHOT FROM THE <i>HADES UNDERWORLD</i> LEVEL.....	143
FIGURE 7.15: FLOWCHART OF THE GENERAL <i>HADES UNDERWORLD</i> LEVEL. ....	144
FIGURE 7.16: MIDI FILES OF THE <i>HADES UNDERWORLD</i> MUSIC ENGINE. ....	146
FIGURE 7.17: FLOWCHART OF THE <i>FOR HELEN</i> BATTLE COMPOSITIONS.....	149
FIGURE 7.18: <i>THE SEA</i> NAVAL MAP USED TO TRAVEL BETWEEN INDIVIDUAL SUBAREAS IN THE LEVEL.....	151
FIGURE 7.19 THE MAIN MENU OF THE GAME IN WHICH A SEQUENCE OF THE OLYMPIAN GODS ARE PASSING FROM THE SCREEN.....	154
FIGURE 7.20: FLOWCHART OF THE <i>ROAD TO TROY</i> MENU MUSIC.....	156
FIGURE 8.1: A HYPOTHETICAL FIRST ORDER MARKOV CHAIN BETWEEN TWO CELLS IN <i>APOTHEON</i> .....	167
FIGURE 8.3: MICRO CELLS MODEL DESIGNED FOR <i>APOTHEON</i> . ....	171

## ACKNOWLEDGEMENTS

I would like to thank the following people for their support without whom this thesis might not have been possible:

The creators of *Apotheon*: Lee Vermeulen (lead programmer) and Jesse McGibney (lead artist) for making such a special and epic game as well as allowing me the artistic freedom to experiment with recombinant music. The 18<sup>th</sup> century composers of musical dice games for their idea of using recombinant structures and probabilities to create musical variation.

Dr. Miguel Mera for his advice, unlimited patience and support throughout my studies. He never missed a single paper presentation of mine. The examiners Dr. Aaron Einbond and Dr. Julio d'Escrivan for their truly helpful comments and suggestions that drastically improved my thesis. Dr. Laudan Nooshin for chairing the viva so professionally and offering me solid advice.

My parents Marina Kouvoutsaki and Kostas Aristopoulos as well as the rest of my family for encouraging me to pursue a Ph.D and constantly supporting me throughout my studies. My friend Dr. Markos Papadonikolakis for his algorithmic advice and his Marylebone hospitality. My fiancée Sara Pikkarainen for repetitively motivating and supporting me.

Dr. Maria Huant for having the patience to proofread my entire thesis. The Music and the Moving Image conference in NYU for inviting me twice to present papers on my research. The Ludomusicology conference for inviting me to present my work as well as inspiring me with their unique selection of papers and mission. Dr. Juan Chattah for pushing me to carry on. Everyone at the department of music in City, it has been a great place to study!

## ABSTRACT

My original contribution to knowledge is a portfolio of 29 compositions written for the open world videogame *Apotheon* that constitutes an improvement to the effectiveness and implementation of recombinant videogame music. This portfolio was developed in response to the criticisms of multiple authors such as K. Collins, W. Phillips, S. Huiberts, A. Burnt, D. Raybould, R. Stevens, and others on the negative effects of excessive use of looping in video game music. A collaboration between myself and the programmer and game designer Lee Vermeulen brought the development of a new stochastic recombinant music engine that was implemented in *Apotheon*. The purpose of the engine is to replace continuous linear looping with unique musical variations in key areas of the game in which players might spend large amounts of time. The music in these areas is dynamically recombined in multiple independent layers using weighted probabilities that are altered according to the development of the narrative. The portfolio was inspired by aleatoric techniques found in 18<sup>th</sup> century musical dice games, and expanded on stochastic recombinant techniques found in earlier videogame soundtracks such as *Ballblazer*, *Times of Lore* and *Legend of Zelda: Ocarina of Time*.

## INTRODUCTION

Video games have come a long way since their beginnings in the 1960s, through constant technological innovations and growing popularity, causing them to become one of the leading forms of entertainment today. According to Jane McGonigal from *TED Institute* around the world three billion hours are spent playing video games every week, while 67% of all US households played video games in 2010.<sup>1</sup> New titles constantly break sales records that surpass the film and music industries in revenue: *Call of Duty: Modern Warfare 3* has recently grossed \$1 billion in just 16 days, beating the entertainment industry record holder 3D film hit *Avatar*.<sup>2 3</sup> Other multiplayer games such as *World of Warcraft* have gathered up to 12 million active monthly subscribers who played the game online, with an average of 22 hours of playing time per player per week.<sup>4</sup>

Like film, the earliest video games were silent, but sound and music quickly found their way into the medium as early as the 70s, with Atari's tennis game *Pong* (1972) using a simple sound effect wherever the player would hit the ball and *Space Invaders* was one of the first games to utilize a looped music accompaniment.<sup>5</sup> Since then, game audio has developed alongside the technological advancements of each era, starting from basic beeping sound

---

<sup>1</sup> McGonigal, Jane. "Gaming Can Make A Better World." TED. N.p., 2010. Web. 9 Aug. 2017. <[https://www.ted.com/talks/jane\\_mcgonigal\\_gaming\\_can\\_make\\_a\\_better\\_world](https://www.ted.com/talks/jane_mcgonigal_gaming_can_make_a_better_world)>.

<sup>2</sup> Stuart, Keith. "Modern Warfare 3 Smashes Entertainment Launch Records." *The Guardian* 2011. Web. 17 Dec. 2016. <<http://www.guardian.co.uk/technology/gamesblog/2011/nov/11/modern-warfare-3-breaks-sales-records?newsfeed=true>>.

<sup>3</sup> Richmond, Shane. "Call Of Duty: Modern Warfare 3 Breaks Sales Records." *The Telegraph* 2011. Web. 17 Dec. 2016. <<http://www.telegraph.co.uk/technology/video-games/video-game-news/8884726/Call-of-Duty-Modern-Warfare-3-breaks-sales-records.html>>.

<sup>4</sup> Yee, Nick. "The DAEDALUS PROJECT: MMORPG Research, Cyberculture, MMORPG Psychology." N.p., 2009. Web. 17 Dec. 2016. <<http://www.nickyee.com/daedalus/>>.

<sup>5</sup> Jørgensen, Kristine. "What Are Those Grunts and Growls Over There? Computer Game Audio and Player Action." N.p., 2007, p. 17.

effects of the early arcades to complex dynamic orchestral soundtracks that have to fulfil multiple functions in today's games.<sup>6</sup>

Despite the worldwide popularity and impact of video games in modern culture, video game music and sound has not received sufficient attention from the academic community, at least not until recently.<sup>7</sup> Considering the fact that music has been an integral part of video games since the 70s as well as the vast number of dynamic soundtracks created and experienced by millions of players around the world since then, it is surprising that even less has been written on the subject of creating and composing video game music.

From the limited academic literature that exists on video game audio, there are certain themes and problems that appear to be central and have been noticed by many writers. The non-linear and unpredictable nature of video games requires a radically different approach from the traditional methods of composition found in other forms of music such as popular music or film scoring.<sup>8</sup> The ability of music to react or adapt to game-play changes and/or to actions taken by the player is usually referred to as dynamic music, which is the term that will be used in this thesis.<sup>9</sup>

It is interesting to note that even the first game to include a continuous musical background, *Space Invaders* in 1978, had simple dynamic elements built into the music. The tempo of the four descending tones in the bass was connected to the actions of the player, as the music would speed up as the aliens come nearer to the bottom of the screen.<sup>10</sup> Since then, and as

---

<sup>6</sup> Jørgensen, 2007, p.17.

<sup>7</sup> Collins, Karen. *From Pac Man to Pop Music*. Routledge, 2008, p.6.

<sup>8</sup> See Collins, *From Pac Man to Pop Music*, chapter 5

<sup>9</sup> Collins, *Game Sound*. Cambridge, MIT Press, 2008, p. 139.

<sup>10</sup> Collins, *From Pac Man to Pop Music*, p.2.

video games and technology developed further, composers and audio designers have invented different techniques to cope with the many challenges of dynamic music. Larger games commonly relied on teams of composers to compose sufficient music that in some cases extended over 45 hours of original music.<sup>11</sup> Videogame design nowadays is starting to embrace new immersive technologies such as Virtual Reality and Augmented Reality that might push the boundaries for dynamic game music further. Procedural generation is frequently used in designing indeterminate game worlds that are increasingly difficult to accompany with traditional linear methods of composition. It is my hope that this thesis constitutes a step forward in the use of stochastic recombinant techniques that will assist in avoiding excessive use of music looping in larger games while providing a musical experience that is closely connected to the development of nonlinear narratives.

## **RESEARCH QUESTIONS & METHODOLOGY**

This thesis explores a number of recombinant music techniques in a portfolio of compositions written for the Steam and PS4 game *Apotheon* that was released in 2015 and developed by the Canadian indie game studio *Alientrap*. The purpose of this research is to explore the use of stochastic techniques and recombinant structures as a solution to the problem of extensive linear looping that is prominent in large open world video games such as *Apotheon*. The techniques explored are not limited exclusively to open world games but can be applied to other genres that feature frequent repetition caused by extended gameplay durations or limited musical material.

---

<sup>11</sup> See World of Warcraft in chapter 1.2

All the recombinant compositions implemented in *Apotheon* were composed and designed by myself and all the programming and implementation was done by the game's lead designer and founder of *Alientrap Games*, Lee Vermeulen. Our collaboration lasted for a period of two and a half years and was conducted primarily through online communication. In addition, the game's co-designer and lead artist Jesse McGibnee as well as a number of game testers contributed to this research by providing constant feedback on the effectiveness of the music in various stages of the game's development.

The methodology that is employed in this thesis is based both on theoretical and practical approaches. Chapter 1 begins by examining the criticisms raised by different writers and composers that have identified repetition as a potential problem in game music. The chapter discusses the reasons looping can become problematic within a videogame context by looking into psychoacoustic studies and comparing its frequent use in other styles of music such as EDM. The open world game *World of Warcraft* is used as a case study to investigate the effects of extensive repetition on player experience and examine some of the techniques composers and game developers have utilised to deal with the issue of repetition. Chapter 2 assesses if recombinant music might be a more effective approach for minimizing music repetition in games and examines aleatoric examples from the broader classical music tradition in order to identify techniques that might be relevant within a gaming context. A particular focus is given to 18<sup>th</sup> century dice games that provided the initial inspiration to this research, while the work of a number of 20<sup>th</sup> century aleatoric composers is also examined.

Chapter 3 traces case studies from the history of video games that have utilized stochastic recombinant techniques and evaluates their effectiveness in combating linear looping.

Chapter 4 examines theoretical recombinant models that have been proposed by researchers



and might surpass some of the limitations of the recombinant systems that have been implemented so far in commercial games. Chapter 5 is an introductory chapter on *Apotheon* that contains background information on the game and its narrative in order to provide the necessary context for the reader to understand the portfolio of compositions. In addition, the overall musical language of the portfolio is discussed and particularly the connection and influences from ancient Greek music and earlier game and film soundtracks with archaic themes. Chapters 6 and 7 are extended chapters that connect all the data from the previous chapters and examine in considerable detail each composition of the accompanying portfolio written for *Apotheon*. All the compositions are analysed in terms of their musical language, the use of recombinant techniques, and their connection to the game's narrative. These chapters are accompanied by the composition of more than 68 minutes of original music, the original game, and multiple examples of footage of gameplay videos for the convenience of the reader.<sup>12</sup> Finally, Chapter 8 discusses possible limitations of the recombinant techniques developed in the portfolio and examines the use of Markov Chains amongst other techniques as a potential future direction in further improving similar systems.

---

<sup>12</sup> Further details on the accompanying material can be found in appendix E

## LIST OF PORTFOLIO COMPOSITIONS

The following tables provide a list of all the compositions included in the portfolio with a description of their function in the narrative and the implementation technique used in the final game. Compositions marked with an “\*” symbol indicate that the music was composed for a recombinant system but was implemented linearly in the commercial release of the game. A detailed analysis of each track is provided in chapters 6 and 7. Figure 0.1 displays all the linear mixes of the tracks as they appear in the commercial release of the *Apotheon* OST and has a total running time of 68 minutes. Linear mixes of these 24 tracks can be found on the accompanying USB, but for a better understanding of how they function it is recommended that they are experienced within the game. Video examples of gameplay footage of some of these tracks can be found in the accompanying USB and a full list of the video examples is provided in appendix E. Figure 0.2 displays a list of five recombinant compositions that were included in the game but not in the *Apotheon* OST. The running time of these compositions that is indicated in the table is only an approximation as it depends on the development of the gameplay.

<b>List of tracks as they appear in the commercial release of the <i>Apotheon</i> OST</b>				
<b>Track #</b>	<b>Name of track</b>	<b>Duration of linear mix</b>	<b>Function in the game</b>	<b>Implementation technique</b>
01	King of the Gods	04:53	Final battle with Zeus	Linear loop
02	Under the Gaze of Ares	02:17	Ambience for Village of Dion	Recombinant Cells
03	The Oracle	04:49	Village of Dion Oracle quest	Recombinant Cells
04	In the Forests of Olympus	04:34	Ambience and general battle in The Forest level	Recombinant (Vertical)
05	The Deer	04:34	Battle with the goddess Artemis	Recombinant (parallel composition)
06	Apollo's Palace	01:33	Ambience for Apollo	Linear loop
07	Hades Underworld	05:55	Ambience and general battle music for Hades level	*Linear loop
08	March from Hades	01:50	Battle with the gods	Linear loop
09	Trojan Shores	03:01	General ambience music	Linear loop
10	Achilles Heel	01:23	Battle with the gods	Linear loop
11	Maze of Athena	02:12	Ambient music for Refuge of Athena quest	Linear loop
12	Street musician 1	00:30	Harp diegetic music	Linear loop
13	Street musician 2	00:30	Flute diegetic music	Linear loop
14	Street musician 3	00:42	Harp diegetic music	Linear loop
15	For Helen Part I	04:08	Battle music	Recombinant (Horizontal)
16	For Helen Part II	03:26	Battle music	Recombinant (Horizontal)
17	For Helen Part III	01:55	Battle music	Recombinant (Horizontal)
18	Ten Years of War	04:05	General Ambience music	Linear loop
19	Defeat	00:34	Player dies in the game or in the multiplayer arena	One shot
20	Stalemate	00:30	Draw between multiplayer arena games	One shot
21	Victory	00:56	Player wins a multiplayer arena game	One shot
22	Atlantis	06:05	Ambience music for Poseidon level	Linear loop
23	Ares- God of War	04:05	Ambience music for Ares level	Recombinant (Horizontal)
24	Road to Troy	02:37	Main menu theme	*Linear loop

Figure 0.1: List of portfolio tracks as they appear in the commercial release of the *Apotheon* OST

<b>Additional music not included in the official <i>Apotheon</i> OST but included in the game</b>				
<b>Video Track #</b>	<b>Name of track</b>	<b>Approximate Duration of linear mix</b>	<b>Function in the game</b>	<b>Implementation technique</b>
Video example 7.4	Village of Dion	≈15:00	Ambience and battle music for Village of Dion quests	Recombinant Cells
Video 7.6	The Caves	≈03:00	Ambience and battle music for Underwater caves & sewers locations	Asynchronous Cells
Video 7.8	Lethe	≈02:00	Ambience music for Lethe quest	Asynchronous cells
Video 7.9	Phlegedon	≈02:00	Action music for Phlegedon quest	Asynchronous cells
Video 7.10	Acheron/Cocytus	≈03:00	Battle music for Acheron/Cocytus quests	Vertical layer

Figure 0.2: List of portfolio tracks not included in the OST but included in the game

## CHAPTER 1: THE PROBLEM OF MUSICAL REPETITION IN GAMES

### 1.1 Repetition in music

Repetition can be observed as a central component of many genres of music such as in the cyclical nature of 18<sup>th</sup> century Rondos, the repetitive pulse driven works of Steve Reich and Philip Glass, or the looping and sampling techniques that are essential in Electronic Dance Music. Ethnomusicologist Bruno Nettl considered repetition to be a music universal shared amongst all known musical cultures in the world, a view supported by cognitive studies in Elizabeth Hellmuth Margulis's book *On Repeat: How Music Plays the Mind* in which she argues that repetitiveness lies at the very core of musical experience worldwide.<sup>13</sup> However, when repetition is examined within a gaming context, a number of writers have identified that the identical repetition of sections, also known as looping, can be one of the major challenges of game music that often leads to listening fatigue and impacts on player experience. This chapter will explore this issue by examining current literature on the subject, comparing looping techniques from other genres, analysing the music engine of the MMORPG *World of Warcraft*, and looking at some of the techniques that have been employed to reduce repetitiveness in games.

The non-linear structure of games as well as the indeterminate length of certain gameplay scenarios frequently put the composer in a difficult position as she or he has to write sufficient music that needs to react to a range of different situations with an unknown duration. Many contemporary video games consist of hundreds or even thousands of gameplay hours that require musical accompaniment. In such cases, composers will have to

---

<sup>13</sup> Margulis, Elizabeth. *On Repeat*, 2014, p.9

write large amounts of original music in order to be able to cover such extended gameplay durations, a task that might be unmanageable for a single composer and often results in use of continuous looping of the same music over different parts of the game. Axel Berndt et al. have written extensively about this issue:

As the length of an interactive scene is usually impossible to predict it is likewise impossible to say how much musical material is needed. The common way to bypass this problem is to loop the music for as long as the scene lasts. This approach involves an existential danger: Sooner or later the player becomes aware of the repetition; the game scenario emerges as a mere mechanical arrangement and loses much of its integrity. Variance is needed that renews the music each time it repeats.<sup>14</sup>

Sander Huiberts in his PhD thesis *Captivating Sound* conducted a survey using 139 gamers in order to examine the role of audio for immersion in games. According to his data, music is mentioned most often by participants for having a negative rather than a positive influence on immersion.<sup>15</sup> Participants gave multiple reasons for this which Huiberts sums into the following categories: 1) when there is no relation between the music and the gameplay 2) when music triggers are too obvious 3) when short, repetitive, and continuous musical loops are used and 4) when cultural references are incorrect. Huiberts argues that too much repetition can become obtrusive as it reveals a lack of interrelation between gameplay and musical structure that considerably decreases the player's immersion.<sup>16</sup>

Karen Collins has also repeatedly identified that extended repetition can become problematic:

The most important feature . . . is that it contains enough permutations and the proper randomization so that players do not feel like they're hearing the same thing repeated over and over. Even the greatest and most satisfying sound, dialog or music will be diminished with too much repetition.<sup>17</sup>

---

<sup>14</sup> Berndt, Axel et al. "Composition and Arrangement Techniques for Music in Interactive Immersive Environments." *Audio Mostly - A Conference on Sound in Games*. Piteå: Audio Mostly, 2006, p.1.

<sup>15</sup> Huiberts, Sander. "Captivating Sound: The Role of Audio For Immersion In Computer Games.", 2010, p.106.

<sup>16</sup> Huiberts, Sander. 2010, p.106.

<sup>17</sup> Collins, Karen. *Playing with Sound: A Theory of Of Interacting with With Sound and And Music in In Video*

Similar remarks on the negative effects of excessive repetition in game music can be found in the majority of existing game audio literature. Some of these examples are the following:

Game composer and author Winifred Phillips in her book *A Composer's Guide to Game Music* mentions that if strong melodic themes are played repeatedly the music might begin to irritate rather than entertain, a problem she refers to as “repetition fatigue”.<sup>18</sup> In the *Essential Guide to Game Audio*, Don Diekneite, game composer of the MMO *Rift*, mentions that in larger games repetition can be one of the main challenges for the composer: “Repetition of the same sound or music can become not only tiresome but downright irritating (even if you liked it at first). So a lot of what we do is aimed at creating variety within a particular sound or music category.”.<sup>19</sup> Raybould and Stevens in *The Game Audio Tutorial* mention that “the chief criticism of game audio over the years has been its repetitive nature”.<sup>20</sup> Michael Sweet in his book *Writing Interactive Music for Video Games* mentions on multiple occasions what he labels as “The Repetition Problem” and suggests that composers can use recombinatory techniques to minimize repetition.<sup>21</sup> Game composer Bear McCreary on a section labelled “Repetition Kills Suspense” suggests that composers should “work with developers to push the boundaries of technology to allow for music that feels less repetitive.”.<sup>22</sup>

Considering the aforementioned criticisms, it can be observed that looping can become problematic for primarily two reasons: a) Listening fatigue caused by looping diminishes the enjoyment of the experience and b) the player becomes aware of the repetitions which reveals

---

*Games*. Cambridge, MA, MIT Press (MA), 14 May 2014, p. 43.

<sup>18</sup> Phillips, Winifred, *A Composer's Guide to Game Music*, 2014, p.66.

<sup>19</sup> Diekneite quoted in Horowitz, *The Essential Guide to Game Audio*, 2014, p.63.

<sup>20</sup> Raybould, Dave, and Stevens, Richard. *The Game Audio Tutorial* 2011, p. 43.

<sup>21</sup> Sweet, Michael. *Writing Interactive Music for Video Games*, 2015, p.20.

<sup>22</sup> Sweet, 2015, p.23.

a lack of connection between developing gameplay and musical structure.

Regarding the first point, it can be argued that looping does not necessarily diminish the enjoyment of the experience as long as the player actually enjoys the music being looped. Repetitive listening patterns can be observed in people that obsessively listen to identical repetitions of their favourite songs for extended periods of time.<sup>23</sup> In fact, *YouTube* had to recently rewrite its code after repetitions of multiple megahits exceeded the maximum possible number of 2 billion views per song and there are now multiple websites that allow listeners to infinitely loop their favourite *YouTube* tracks.<sup>24</sup> Players can react considerably differently to use of looping in a game according to their musical preferences. For example, examining an internet forum post on the music of the game *Fantasy Life* it can be observed how players have widely contradicting opinions on the use of musical repetition in the game. One gamer states “danielfromhood: I haven't been this annoyed by a game's music in a long time. It's just so, so repetitive and gets on my nerves. Anyone else feel this way?”. Some players seem to agree with him, “Applefishy: I like it but it does get repetitive. Sometimes I turn the sound down.” while others are in complete disagreement “stephanieisit: No, I love it :)” or even “Kill\_Jill\_Vol\_1: Nope, this game is just a heavenly symphony”.<sup>25</sup>

However, psychoaesthetic studies in the past have shown that the higher the number of repetitions of a theme, the more likely it is that it will eventually become monotonous. The Wundt curve below illustrates that growing familiarity with a certain theme might increase pleasure but as repetition continues it will ultimately cause displeasure.<sup>26</sup>

---

<sup>23</sup> Margulis, *On Repeat*, 2014, p. 95

<sup>24</sup> Savage, Mark. "Gangnam Style is no Longer the Most-Played Video on YouTube." *BBC News*. N.p., 2017. Web. 9 Aug. 2017. <<http://www.bbc.co.uk/news/entertainment-arts-40566816>>.

<sup>25</sup> Life, Fantasy. "Why is the Music in this Game so Bad and Repetitive? - Fantasy Life Message Board For 3DS - Gamefaqs." *Gamefaqs.com*. N.p., 2017. Web. 9 Aug. 2017. <<https://www.gamefaqs.com/boards/971712-fantasy-life/70578512>>.

<sup>26</sup> Margulis, 2014, p. 96



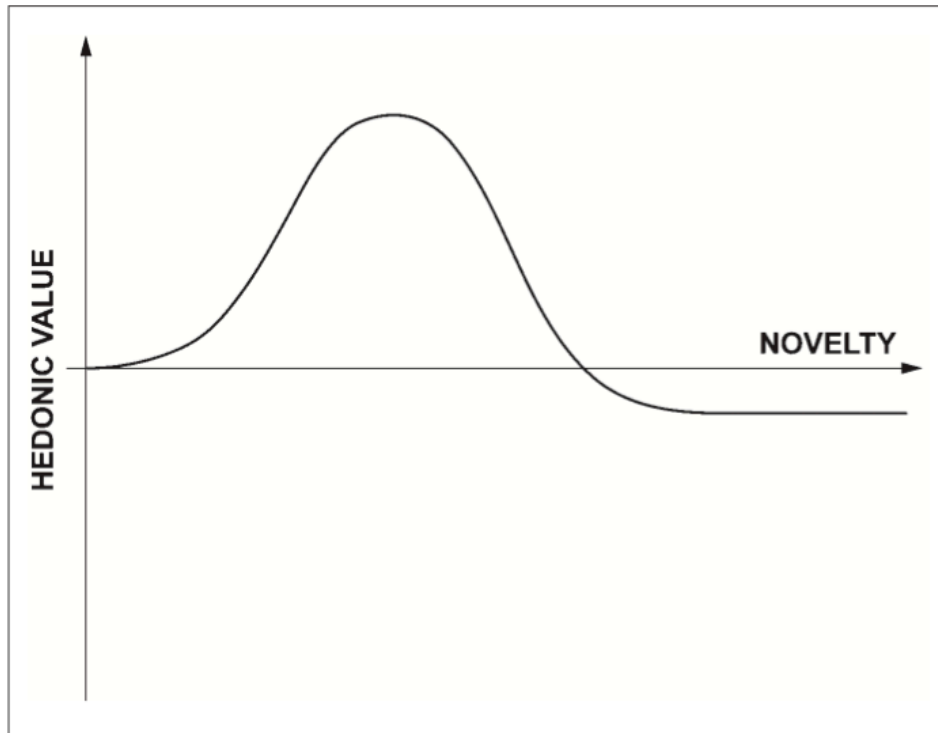

Figure 1.1: The Wundt curve outlines the relationship between stimulus novelty and enjoyment (hedonic value) over time.<sup>27</sup>

E. Margulis suggests that complexity of the composition itself affects the listener response to repetition: if the composition is too simple, multiple repetitions would quickly increase boredom; if the composition is more complex, repetitions would gradually increase enjoyment as the piece would be eventually better understood.<sup>28</sup>

In order to put these findings into a game music perspective it is worth considering musical repetition in a play-through of the entire game of the original *Super Mario Bros* for NES. If the player is an absolute expert and manages to finish the game in only five minutes, he will listen to the music being looped eight times. An average play-through of the game takes approximately 15 minutes and will result in the music being looped 24 times. A slow play-through from an inexperienced player could take up to 60 mins and will result in the music

---

<sup>27</sup> Margulis, 2014, p. 96

<sup>28</sup> Margulis, 2014, p. 97

being looped 96 times which is highly probable to irritate the player regardless of his or her fondness of the music or the complexity of the original composition.<sup>29</sup> In another more exaggerated example, the game *Supaplex* (1991) uses a single looped theme for each of its 111 levels that take at least 7 hours to complete by a perfect play-through.<sup>30</sup> It is possible that games such as these exhibited limited use of music mainly due to the space restrictions found in the consoles of the time, a problem that some experimental developers tried to address with the use of generative music which will be examined in Chapter 3.

The second criticism of aforementioned writers on looping (awareness of identical repetitions can expose the music as having no connection to what is going on in the game) is also dependent on the individual player, as the ability to perceive musical repetition is a variable skill. Musical perception of repetition is a complex psychological process that is also dependent on the context and nature of the repeating elements among multiple other factors that have only recently begun to be understood by cognitive scientists.<sup>31</sup> Therefore, players might notice music repetition at different stages of gameplay, or in some cases not at all. Regardless of these differences in the awareness of repetition, extensive use of the same music looped over a wide range of gameplay scenarios is likely to create an inconsistent experience for the player. In order to highlight this problem, it is worth considering why looping appears to often become problematic in games, while it is celebrated in musical genres such as EDM.

---

<sup>29</sup> Thompson, Matthew. "Analysis: Repetitive Game Music Via Super Mario Bros." *Videogamemusicnerd.blogspot.co.uk*. N.p., 2017. Web. 9 Aug. 2017. <<http://videogamemusicnerd.blogspot.co.uk/2012/08/on-repetitive-nature-of-video-game-music.html>>.

<sup>30</sup> "PC Longplay [357] Supaplex." *YouTube*. N.p., 2013. Web. 10 Aug. 2017. <<https://www.youtube.com/watch?v=8dMF3jU-nwc>>.

<sup>31</sup> See Margulis, Elizabeth Hellmuth. "Musical Repetition Detection Across Multiple Exposures." *Music Perception: An Interdisciplinary Journal* 29.4 (2012): 377-385

Luis-Manuel Garcia's paper "On and On: Repetition as Process and Pleasure in Electronic Dance Music" argues that the fundamental units of musical structure in EDM are short loops that are layered, added, and subtracted to create a "seemingly paradoxical effect of an ever-changing same."<sup>32</sup> Mark Butler has proposed that the extended repetition of such loops allows listeners to shift their focus and observe different textural layers as the composition develops gradually. The development of EDM music often follows what Mark Spencer has defined as "accumulative form" in which compositions do not begin with the presentation of a complete theme followed by the development of its individual material but rather begin with repeating looped fragments of the main theme which eventually accumulate to a full climactic presentation at the end of the song.<sup>33</sup>

If we compare the use of looping described above with the use of looping in games, we can observe some fundamental differences. In EDM, individual short loops within the song's structure are gradually manipulated in order to build tension and release and eventually reach a pre-planned goal which will likely be followed by a quick transition to a new song. In games, the literal repetition of entire compositions does not happen because of a greater plan to reach a musical goal but simply out of necessity to accompany extended gameplay durations and outcomes with limited thematic resources. Regardless of the enjoyment that might or might not be generated from repetitive listening of a game's soundtrack, the failure of looped sections to adapt to variable gameplay can potentially make the music appear unrelated to the gaming experience, and therefore, potentially meaningless.

---

<sup>32</sup> Garcia, Luis-Manuel. "On and On: Repetition as Process and Pleasure in Electronic Dance Music." *Music Theory Online* 11.4 (2005), p.7

<sup>33</sup> Garcia, Luis-Manuel. (2005), p.7

In order to explore these issues in more depth, I will examine the player experience of the music in one of the largest and most commercially successful MMORPGs (Massively Multiplayer Online Role Playing Game) of our time, *World of Warcraft* and its expansions developed by Blizzard Entertainment.

## 1.2 Musical Repetition in Open World Games & World of Warcraft

Open world games such as *World of Warcraft* strive to grant as much freedom as possible to the players. Todd Howard, the director of Bethesda Software, states that in a successful open world design players should have the freedom of doing what they want to rather than follow a linear pathway preset by designers: “The more open, the more reactive you can make it, the better the player experience.”<sup>34</sup> Mike Singleton, the developer of *Midwinter*,<sup>35</sup> one of the early open world games and one of the first 3D games for the PC, states that the game “was inspired by a desire to recreate an in-depth, free-roaming world where you have an almost infinite number of ways to approach the game and win it”.<sup>36</sup> One of the most famous gaming franchises that uses an open world narrative is the *Grand Theft Auto* series developed by Rockstar Games which had sold over a 125 million copies by 2012. Brian Baglow, who worked on the development of the first game, commented that it “made the player just another character in a whole world going about its daily business. The environment is not merely the setting for the action, but is an active part of the overall gameplay, which affects and reacts to the player as they progress”.<sup>37</sup> From the above examples it is clear that such games do not employ a linear narrative that could be successfully accompanied by continuous

---

<sup>34</sup> Sefton, Jamie. "The Roots of Open-World Games." *Games Radar*. 2008. Web. 17 Dec. 2016. <<http://www.gamesradar.com/the-roots-of-open-world-games/>>.

<sup>35</sup> Developed by *Maelstorm Games*, 1989.

<sup>36</sup> Sefton, Jamie. "The Roots of Open-World Games." *Games Radar*. 2008. Web. 17 Dec. 2016. <<http://www.gamesradar.com/the-roots-of-open-world-games/>>.

<sup>37</sup> "The Complete History of Open World Games Part II." *Computer and Video Games*. N.p., 2017. Web. 16 May 2016. <<http://www.computerandvideogames.com/189599/features/the-complete-history-of-open-world-games-part-2>>.

looping, but rather create an indeterminate player-based experience that might require new, radical ways of approaching the music.

*World of Warcraft* requires a significant time commitment from players. According to a study of over 35,000 people, players spend on average 22 hours a week playing the game, with 60% of them reporting that they have played for at least 10 hours continuously.<sup>38</sup> Just to reach level 60 out of the 80 possible character levels that exist in the game requires an average of 384 hours of playing time. It is difficult to accompany such an enormous gameplay experience without resorting to frequent repetition of the music. Due to the huge commercial success of the game, the audio team was unusually large and consisted of a team of composers, who created more than 45 hours of original music. Jason Hayes, who was the lead composer on the project, stated:

I think the big struggle with a game like *World of Warcraft* or any huge persistent world where people will be in for a number of years is definitely trying to figure out how to address that kind of experience with music. Not just the fact of it becoming boring, which of course is a factor, but even what would be appropriate. ...if someone is hanging around in a location of the world for hours, it's very difficult to even conceive how you would approach that aesthetically from a musical standpoint.<sup>39</sup>

Although 45 hours of original music is an impressive amount of music for a single game, we have to consider that all this music is spread out in a massive 3D world and has to accompany years of gameplay. By examining the number of areas that this music has to cover and the number of average player visits for each area (figure 1.2) we can observe that certain central locations in the game such as *Ironforge* and *Ogrimmar* are visited much more frequently than other such as *Darnassus* and *Silverpine Forest*. Players would also usually spend a longer

---

<sup>38</sup> Yee, Nick. "MMORPG Demographics." " *PRESENCE: Teleoperators and Virtual Environments*, vol. 15, no. 15, (2006, pp.): 309–329. Web. 17 Dec. 2016., <<http://www.nickyee.com/pubs/Yee%20-%20MMORPG%20Demographics%202006.pdf>. Accessed>.

<sup>39</sup> Chiappini, Dan. "Q&A: World of Warcraft Composer Jason Hayes." GameSpot. N.p., 2007. Web. 10 Aug. 2017. <<http://www.gamespot.com/articles/qanda-world-of-warcraft-composer-jason-hayes/1100-6172231/>>.

amount of time in those areas as they are the capital cities of the main races in which players frequently need to return to for completing main quests, trade items, and socialize with other players, thus listening to their respective level music countless times.

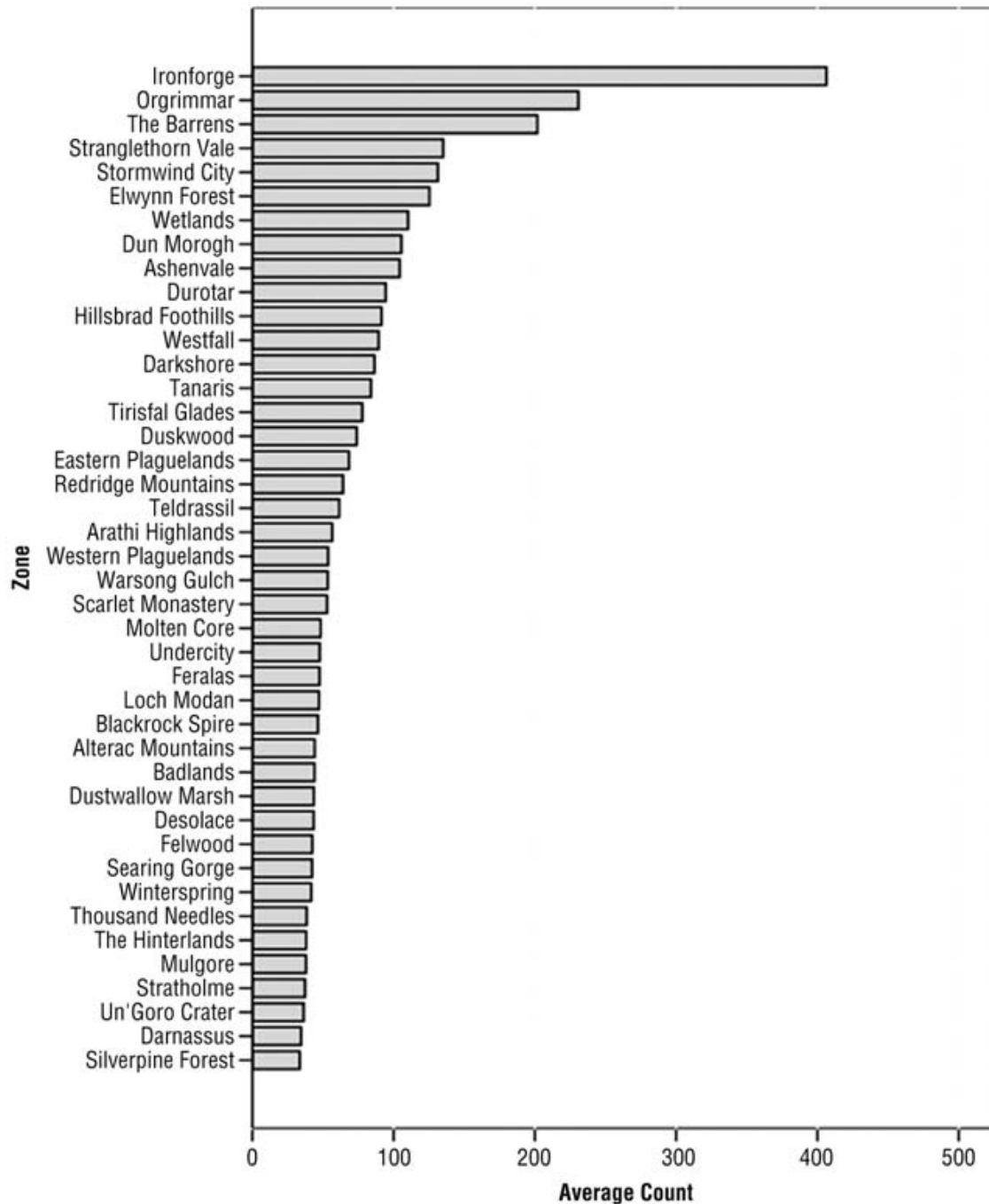

Figure 1.2: Average player visits per zone in *World of Warcraft*<sup>40</sup>

<sup>40</sup> Ducheneaut, Nicolas, et al. "Building an MMO with Mass Appeal: A Look at Gameplay in World of Warcraft.", p. 306.

## **World of Warcraft player survey**

In order to better understand how players experience musical repetition in *World of Warcraft* I conducted a brief player survey using a sample from a Blizzard enthusiast gaming group in Facebook named *Our Own Diablo III Private Gaming Group*. The group started as a private fan base community for discussion relating to Blizzard's *Diablo III* game but soon also encompassed discussions on *World of Warcraft*. At the time of the survey, the group had 27 active members of ages 18 to 37, 4 females and 23 males. The members were asked to describe their experience of the music while playing the game and it is important to note that there was no reference or question about repetition in order to avoid receiving biased responses. The participants were asked the following question:

Fellow gamers, I am analysing the music engine of World of Warcraft for my PhD research and would like your input. What has your experience been with the music of the game so far? Do you have any memories of a theme from a specific zone or a boss fight? Please also indicate your age, total time played, and if you are currently an active player.

The responses received can be seen in appendix B but only comments that were relevant to the survey have been included as a number of replies were unfortunately focused on teasing the playing abilities of other members or discussing irrelevant parts of the game. Although the number of participants in the survey is considerably limited to provide concrete data, the sample group consisted of experienced gamers that had played the game for a significant amount of time and could therefore provide a good indication on the experience of listening to the game's music over prolonged periods of time. The majority had played the game for more than two years with only one member claiming to be a beginner who had been playing the game for only a few weeks. The playing time indication provided with each answer refers to the total gameplay hours spent within the game represented in 24 hour days, a statistic that is easily accessible to each player by typing /played in the game's console. For example, if a

player mentions that he has logged 61 days played it translates to 1464 hours of gameplay.

By examining the answers received some interesting behavioural observations can be made but larger studies need to be conducted for these results to be validated. Most players seemed to enjoy the music at the beginning but without any suggestion about repetitiveness from the questionnaire, they tended to highlight the fact that the music eventually became repetitive and they preferred to listen only to the ambient sounds instead.

-In the beginning I was fascinated with the music and enjoyed listening to it. After countless hours of playing it became dull and I decided to turn it off completely. I preferred listening to the ambient sounds of the zones such as birds and water streams rather than repetitions of the same music (Female 29 years old, 61 days played).

-The music did not seem to change apart from when entering a city or an instance. At first I liked having it in the background but as with the rest of the content in the game, if it is not updated it becomes boring, especially when it does not adapt to what you are doing (Male 27 years old, 55 days played).

- I enjoyed listening to the music as I was levelling in the game but turned it off in the final stages of the game (instances, raids etc). I liked the fact that the music would fit the ambience of the zone that you were, depending on the race, history and culture of the area (Male 26 years old, 40 days played).

Players that were more focused on their performance in the game chose to have the music switched off in order to be more aware of their surroundings. It is important to note that during the later stages of the game, players usually attempt raids in large groups of 40 people that typically communicate using live voice software such as Ventrilo. Therefore, any sonic information except the in-game sound effects would be distracting and possibly reduce their chances of success.

-I had the music set in very low volume and preferred to listen to the ambience. When there was Ventrilo communication music was always off (Female 33 years old, 25 days played).

- After the 1<sup>st</sup> year I have it strictly off as I need to listen to the SFX which are much more important in understanding your surroundings and respond in time (Male 35 years old).

- As any serious player does, I had turned the music off in the final stages of the game (Male 31 years old, 90 days played).



A similar survey with a much wider sample was conducted by G. Parsons et. al.<sup>41</sup> The authors asked 226 participants on multiple online forums “So what is everyone listening while playing World of Warcraft?”. As it can be seen from figure 1.3, an overwhelming 96% of the respondents answered that they listen to various music genres with Rock/Metal appearing to be the most popular choice. Remarkably, only 8 participants, or 4% of the sample, answered that they listen to the original in-game music. From the data presented on this survey there is no indication on the time that the participants had invested in the game before taking the survey, which makes it difficult to draw any conclusions on the reasons behind choosing to move away from the original music. Moreover, the way the survey question was formed was suggestive of listening to a particular genre of music, and did not encourage replies that might have included the option of having the music switched off entirely. For the reasons examined so far, it is evident that musical repetition in larger video games such as *World of Warcraft* that feature extended gameplay durations can become a significant problem for some players, as looping will often have a negative effect on the gameplay experience. The next section will briefly discuss some of the possible simple solutions that have been utilized by composers, developers, and players to minimize this issue.

---

<sup>41</sup> Parsons, Gavin, Meaghan Connor, and Mark James. "Music and The World Of Warcraft." N.p., 2017. Web. 10 Aug. 2017. <<http://www.richardcolby.net/files/Parsonsetal.pdf>>.

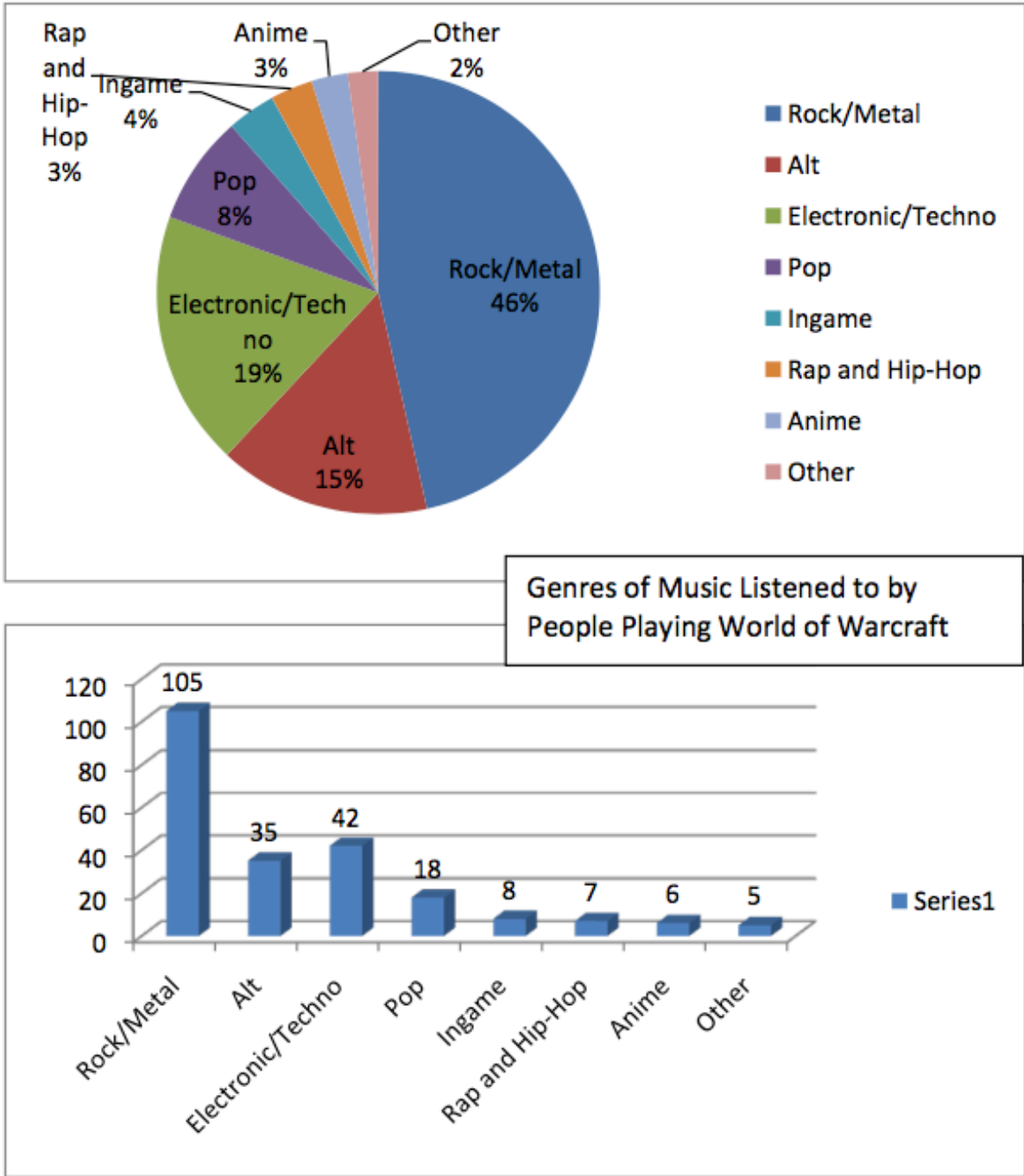

Figure 1.3: Genres of music listened to by gamers while playing World of Warcraft<sup>42</sup>

<sup>42</sup> Parsons, Gavin, Meaghan Connor, and Mark James. "Music and The World Of Warcraft." N.p., 2017. Web. 10 Aug. 2017. <<http://www.richardcolby.net/files/Parsonsetal.pdf>>.

### 1.3 Techniques for reducing repetition in MMORPGs

#### Use of Silence

One of the most valuable tools in minimizing repetition has been the use of silence. Although initially many developers had been afraid to use silence in their games and instead chose to have continuous musical accompaniment throughout, it is now more common to make games that contain large sections without music. According to Russel Brower, the audio director of Blizzard, using silence allows players to absorb the ambience of the space more effectively while using music more sporadically in the game world and also assists in highlighting and enhancing key structural story moments in the game.<sup>43</sup>

The MMORPG *Star Wars: The Old Republic*, that was created/developed after *World of Warcraft*, has made heavy use of this technique.<sup>44</sup> As with most MMORPGs, the game consists of an extended 3D world for players to explore in an enormous gameplay experience. The game music was recorded using a live orchestra and live choir and was written by a team of three composers. In addition to this original music, the game also contained a few musical cues from previous *Star Wars* games as well as some of John Williams's iconic themes from the original *Star Wars* film saga. Contrary to many other games of this genre, the audio team chose to use music sporadically throughout the game. The majority of the time the soundscape consists only of ambience and diegetic sound effects while music only appears to be triggered at random intervals that are usually far apart. Most musical cues appear during specific cinematic sequences or while the player launches the game. Although there has not been any official research on how players experience such a musically sparse game world it is interesting to examine some of the player reactions that were written in the official *Star*

---

<sup>43</sup> Russell, Brower. "The Music of Mists: An Interview with Russell Brower." *World of Warcraft*. N.p., 2016. Web. 9 Aug. 2017. <<https://worldofwarcraft.com/en-gb/news/9762739/the-music-of-mists-an-interview-with-russell-brower>>.

<sup>44</sup> Developed by *Bioware*, 2011.

*Wars* game forums.

I enjoy the music in this game in pretty much every zone I'm in, but with all the work that went into creating the music, why can't we have it play all the time? There is a lot of time when I'm going from place to place that there is no music and all I can hear is my speeder... quite boring. Please give us the option to loop the music.<sup>45</sup>

Most of the comments in the forums contradict the player comments presented in the *World of Warcraft* case study earlier. A number of players ask the developers to implement a continuous loop music option as the game feels too quiet while one player wonders if this game has any music at all.<sup>46</sup> Judging from these reactions and from personally playing the game over a period of time it is obvious that such an extreme approach can minimize if not even eliminate any sense of musical repetition, as music accompaniment is a rare occurrence in the game. This raises an interesting question of how much music is actually needed in such a game and, even, whether music is needed at all.

### **Writing more original music**

Aside from not using enough music for the experience to become repetitive, another solution for avoiding repetition can be the opposite approach, which is to simply create enough original music to avoid constant repetition of the same material. If a project has a high enough budget, such as in the case of *World of Warcraft* or the *Star Wars* franchise, it can hire a large number of composers that usually score different portions of the game. It is also not uncommon for indie games to use multiple composers to cover their extended musical needs. In certain cases, independent developers create add-ons for popular games that expand

---

<sup>45</sup> "STAR WARS: The Old Republic - Why can't we have Music Play at All Times?" N.p., 2005. Web. 17 Dec. 2016. <<http://www.swtor.com/community/showthread.php?t=821862>>.

<sup>46</sup> "STAR WARS: The Old Republic - Why can't we have Music Play at All Times?" N.p., 2005. Web. 17 Dec. 2016. <<http://www.swtor.com/community/showthread.php?t=821862>>.

the musical palette of the original game with additional original compositions. For example the add-on *Authentic Ancient World: Roma Surrectum II Music Pack* adds 200 original new compositions to the game *Rome Total War*<sup>47</sup> made by 16 different composers.<sup>48</sup>

Although using more original music is certainly an effective way of reducing repetitive looping, not all game companies have the luxury of employing a large audio team. More importantly, there is also the issue of the coherence of a game's soundtrack. Employing a large number of composers carries the danger of creating a stylistically inconsistent soundtrack especially if freelancers work from their personal studios rather than working within the same studio as a team. For example, in the *Roma Surrectum Music Pack* mentioned above, there was no communication between the composers and the pack consisted of individually written compositions in a similar style placed in one music package.<sup>49</sup> In large game companies such as *Blizzard*, composers usually work together in the company's studios and the project is guided by a lead composer who supervises the entire soundtrack.<sup>50</sup> *World of Warcraft* used 17 different composers with Jayson Hayes leading the project. Unfortunately, no matter how big the composition team is, some games are simply too large to be accompanied in their entirety by original music. For example, *Daggerfall II: The Elder Scrolls*<sup>51</sup> uses an algorithmically generated open 3D world that the player can navigate which is equivalent to the size of Great Britain. No realistic amount of pre-recorded music can effectively cover such extended gaming experiences without looping, especially considering budget as well as disk space limitations.

---

<sup>47</sup> Developed by *Creative Assembly*, 2013.

<sup>48</sup> "Steam Workshop: Authentic Ancient World: Roma Surrectum II Music Pack (And More) - Part I Of IV." *Steam. Web*. 17 Dec. 2016. <<https://steamcommunity.com/sharedfiles/filedetails/?id=294417870>>.

<sup>49</sup> Based on my communication with the game developers as I was one of the composers in the project.

<sup>50</sup> "Interview: Blizzard Entertainment Audio Team." *Blizzard*. N.p., 2014. Web. 17 Dec. 2016. <<http://speakhertz.com/6716/interview-blizzard-entertainment-audio-team>>.

<sup>51</sup> Developed by *Bethesda*, 1996.

## Custom Playlists

Another technique, which has frequently been used both officially by developers and many times unofficially by players themselves, is to create custom playlists out of personal music collections and listen to them while playing a game. While this approach certainly adds an infinite amount of variability and is appropriate for certain scenarios, it can also be problematic. Most games offer the option to simply switch the original music off and keep only the necessary original sound effects on, allowing players to listen to their own choice of music while playing the game. Although this practice appears to be quite common amongst gamers, it is better suited for games with highly repetitive gameplay that the player has already experienced multiple times, since it is impossible to know what type of music would fit a particular part of an unfamiliar game. This could potentially diminish the gaming experience, as the music chosen might not be suitable to the development of the narrative and/or mood of the game. Moreover, as the music is not originally written for the game nor is it connected with the game engine, it can easily clash with sound effects or vital sound cues causing the player to miss important information, as well as fail to highlight important changes in the narrative.

Some custom modifications even offer the option of customizing the soundtrack of a game, allowing players to choose their own music for different parts of the game. Although this creates a greater adaptive experience than just listening to unrelated playlists that are not connected in any way to the game, not every player will necessarily want to spend time setting their own soundtrack for an entire game. A good example of this is the *World of Warcraft add-on Soundtrack* made by independent authors and available free of charge.<sup>52</sup>

---

<sup>52</sup> Felphyre. "Soundtrack - World of Warcraft Custom Mod." N.p., 2016. Web. 17 Dec. 2016. <<https://mods.curse.com/addons/wow/soundtrack>>.

This software allows you to assign your own music to specific gameplay events rather than using the original music and has been downloaded by more than 90,000 people. The following quote taken from the software's official website demonstrates the case:

Ever get tired of World of Warcraft's default music? Wish you could inject a little bit of aural life into your game, but on your own terms? Soundtrack is the mod for you! Soundtrack allows you to assign any music you own from your own personal music library to almost any event in the game, including death, getting on your mount, leveling up, entering stealth, and various forms of combat that can distinguish between world mobs, PvP, boss battles, and more! When the event occurs, Soundtrack will play the music you have assigned to that event, almost as if the music were a part of the game itself!<sup>53</sup>

The fact that independent programmers frequently create custom modifications for games that allow players to customize their music engines, indicates that there is indeed a player demand for such an approach which could be the result of a highly repetitive music experience offered by the original soundtrack.

---

<sup>53</sup> Felphyre. "Soundtrack - World of Warcraft Custom Mod." N.p., 2016. Web. 17 Dec. 2016. <<https://mods.curse.com/addons/wow/soundtrack>>.

## Chapter 1 Summary

This chapter examined how the use of constant looping is an ongoing challenge in game music that has been identified by multiple game audio authors. Extensive looping diminishes the player experience and immersion due to 1) listening fatigue and 2) the lack of connection between gameplay and musical structure. Psychoacoustic studies from cognitive scientists such as Elizabeth Margulis suggest that listening fatigue is caused by reasons like the number of repetitions, the listener's musical taste, the listener's musical perception, and the complexity of the compositions. As prior composers and researchers have mentioned, and as the survey conducted using *World of Warcraft* has confirmed, this problem becomes more prominent in larger open world games that offer a nonlinear narrative and can have extended durations consisting of thousands of gameplay hours. Composers and developers have developed a variety of techniques to combat repetition such as embracing the use of silence, writing large amounts of original material by using teams of composers and allowing players to replace original music with their own custom playlists. The implementation of these techniques has proven to be partly efficient in some cases while in others has raised new challenges. The next chapter will explore the use of recombinant techniques and the use of chance methods from aleatoric compositions as an alternate method of reducing identical repetition.



## CHAPTER 2: INTRODUCING VARIABILITY THROUGH RECOMBINANT TECHNIQUES

For the reasons discussed in the previous chapter, it is clear that repetition can be a prominent and frequent problem in large open world games that can significantly diminish player experience. The main question that is addressed in this chapter is the following: Can recombinant techniques reduce musical repetition? I argue that it is the use of stochastic methods that can introduce variability in recombinant music and I examine the use of chance in various aleatoric compositions of the classical tradition in order to examine their potential use in recombinant game music.

### 2.1 Non-stochastic recombinant algorithms

Composers and audio programmers have developed audio engines in which triggers, layers and transitional matrixes are used to create recombinatory structures with many variable outcomes. These types of systems are usually realised within appropriate middleware software such as *Wwise* or *Fmod* which offer composers the ability to create complex dynamic systems using a graphical interface and without the need to be fluent in programming languages. The use of such recombinant techniques have been well recorded in various game publications on dynamic music and they can be mainly categorized as horizontal resequencing and vertical recombination.<sup>54</sup> It is significant to note that the motivation for the use of such dynamic techniques is most probably not the reduction of repetition, but the ability to create a flexible score which can adapt to a number of different possibilities that might arise during gameplay.

---

<sup>54</sup> See chapters 11 and 12 in Phillips, Winifred. *A composer's guide to game music*. MIT Press, 2014.

It is easy to assume that since recombinant music consists of flexible linear and vertical structures that are controlled by indeterminate timing variables, it is better suited to creating musical variation than a fixed linear composition. However, this assumption is not necessarily always accurate. These types of dynamic techniques can be useful in action games when immediate changes in the music are frequently required, as they can respond to gameplay changes without any delay.<sup>55</sup> However, if chance is not incorporated in the implementation of these techniques then they can produce a highly repetitive experience if applied to extended gameplay sections. Not only will the music itself be repeated but also the identical underlying mechanisms that control it. Huibert's work on the effects of music in player immersion discussed in chapter 1.1 highlighted this issue as one of the biggest barriers to immersion.

Video example 2.1 is a clear example of this issue. This video is a promotional demonstration for a highly dynamic music engine titled *PSAI* that has been developed for the *Unity Gaming Engine* for the purpose of offering a greater amount of adaptability than previous systems. The audio designer has implemented various musical motives that are triggered according to the distance between the player and the painting in the end of the hallway. By watching this video example, we can observe how the recombinant music engine clearly responds quickly in order to follow the action and build appropriate tension. While this approach could work successfully in a short linear context it is obvious that it can potentially have disastrous results in a longer open world game. Even during the three minutes that the gameplay footage lasts, the relationship between music and gameplay becomes quickly apparent and repetitive. Every time the player takes a step towards the painting, the same suspenseful motifs are triggered, but with each step back, a quickly recognizable calmer motif is crossfaded.

---

<sup>55</sup> Collins, *Game Sound*, p. 99.

From the above example we can argue that the use of recombinant techniques does not necessarily reduce music repetition in game music but in cases like the implementation of non-stochastic recombinant methods it can actually augment it further by making the player aware of the repeating underlying triggers that connect music and gameplay structure. Therefore, the use of recombinant techniques may create a more dynamic structure but does not necessarily assist in substantially reducing repetition more than a looped linear approach. A potential solution to this problem can be found by examining examples of aleatoric music that introduce chance in the generation of their musical structure.

## 2.2 Early examples of Aleatoric Music

Aleatory is a term that refers to music in which a deliberate use of chance or indeterminacy is introduced by the composer in the composition and/or performance of the work.<sup>56</sup> It can be argued that since it is impossible for a composer to entirely control the performance of a composition, all music can be viewed as aleatoric to a certain extent. However, the term is more often applied to instances in which composers have intentionally made an withdrawal of control rather than attempting to precisely determine every aspect of the performance.<sup>57</sup> Paul Griffiths identifies three types of principal aleatoric techniques: “(i) the use of random procedures in the generation of fixed compositions”; “(ii) the allowance of choice to the performer(s) among formal options stipulated by the composer”; and “(iii) methods of notation which reduce the composer’s control over the sounds in a composition”.<sup>58</sup> The first

---

<sup>56</sup> Randel, Don Michael. *The Harvard Dictionary of Music*, 2003, p.32

<sup>57</sup> Griffiths, Paul. "Aleatory." *Grove Music Online. Oxford Music Online*. N.p., 2011. Web. 9 Aug. 2017. <<http://www.oxfordmusiconline.com.wam.city.ac.uk/subscriber/article/grove/music/00509>>.

<sup>58</sup> Griffiths, Paul. "Aleatory." *Grove Music Online. Oxford Music Online*. N.p., 2011. Web. 9 Aug. 2017. <<http://www.oxfordmusiconline.com.wam.city.ac.uk/subscriber/article/grove/music/00509>>.

two methods will be examined further as they are relevant to the development and use of the recombinant music in *Apotheon*.

### **Musikalisches Würfelspiel**

The use of random procedures in the generation of fixed compositions is evident in at least 20 *Musikalisches Würfelspiel* (musical dice games) of the late 18<sup>th</sup> and early 19<sup>th</sup> centuries that have been attributed to well-known composers such as Wolfgang Amadeus Mozart, Joseph Haydn, C.P. E. Bach, and Antonio Callegari among others.<sup>59</sup> Griffiths and Cope have claimed however, that these attributions were possibly made for commercial justification and many of them have not been fully authenticated.<sup>60, 61</sup> It is interesting to note that the term aleatory comes from the Latin word “alea” which can be translated as dice.<sup>62</sup> Johan Julius Hummel first published a dice game attributed to Mozart in 1793 and it is probable that many succeeding editions attributed to Mozart derived from this publication.<sup>63</sup> The idea behind musical dice games which Cope considers to be the first formal types of algorithms in music history, is that a series of pre-composed measures are recombined according to the throw of a number of dice (typically one or two) in order to generate a vast number of new but stylistically coherent compositions.<sup>64</sup> This principle was one of the major influences for the composition and development of the recombinant music of *Apotheon* as a means to achieve a consistent soundtrack that avoids constant looping.

---

<sup>59</sup> Ariza, Christopher. "Two Pioneering Projects from the Early History of Computer-Aided Algorithmic Composition." *Computer Music Journal* 35.3 (2011): p.44

<sup>60</sup> Putnam, Karl W., and David Cope. "Experiments in Musical Intelligence." *Computer Music Journal* 21.3 (1997): 102

<sup>61</sup> Griffiths, Paul. "Aleatory." *Grove Music Online. Oxford Music Online*. N.p., 2011. Web. 9 Aug. 2017. <<http://www.oxfordmusiconline.com.wam.city.ac.uk/subscriber/article/grove/music/00509>>.

<sup>62</sup> Grant, M. J. *Serial Music, Serial Aesthetics*, 2005, p.94

<sup>63</sup> Ariza, 2011, p.44

<sup>64</sup> Cope, et. al. *Virtual Music*, 2001, p.4

Mozart's *Köchel 516f* consists of two eight bar recombinant phrases that are rearranged with the throw of two dice and is capable of producing enough new music that the "entire population of eighteenth-century Europe, working a lifetime on these games could not exhaust the combinations"<sup>65</sup>, or to be mathematically precise:  $11^{16} = 45,949,729,863,572,161$  different compositions.<sup>66</sup> The music is given to the performer as a two-part keyboard notation of 176 pre-composed measures with the melody appearing on the upper part and the accompaniment on the lower. Indeterminacy is introduced in the generation of the composition as the roll of two dices is used to determine the order of the pre-composed measures in order to create two eight bar phrases that should be played in succession. The sum of two dices ranges from a possible value of 2 to 12 and corresponds to 11 possible options assigned to each of the 16 bar positions according to two accompanying matrices that represent the possible combinations for each bar. As it can be seen in figure 2.1 each bar number is represented by a letter that corresponds to a column of 11 possible options for that bar and is determined by the sum of each dice roll. From this matrix and by examining the corresponding pre-composed measures from the score we can make the following observations:<sup>67</sup>

1) Although chance is applied to determine the structure of the first eight bars, not all recombinations are permitted as each bar is restricted to 11 specific possible options. Such a limitation allowed the composer to retain a specific harmonic progression as if all 11 phrases are built around the same chord then the harmonic progression would be identical in every recombination. From an analysis I conducted on the score, all measures within the same row indeed belong to the same chord. For example, opening columns A and B contain only bars

---

<sup>65</sup> Ratner quoted in Cope, et. al. *Virtual music* p.6

<sup>66</sup> Cope, D. "Recombinant Music" *Computer* 24.7 (1991), p.22

<sup>67</sup> A copy of the score has been included in the accompanying material of the thesis. More information can be found in appendix E.

that are based on the C major triad which is the tonic of the piece while row C contains only bars that are based on G major triad which is the dominant of the piece.

	A	B	C	D	E	F	G	H
2	96	22	1+1	+1	105	122	11	30
3	32	6	128	63	1+6	46	134	81
4	69	95	158	13	153	55	110	24
5	40	17	113	85	161	2	159	100
6	1+8	74	163	45	80	97	36	107
7	104	157	27	167	154	68	118	91
8	152	60	171	53	99	133	21	127
9	119	84	114	50	140	86	169	94
10	98	142	42	156	75	129	62	123
11	3	87	165	61	135	47	147	33
12	54	130	10	103	28	37	106	5

Figure 2.1: The accompanying matrix for the first phrase from dice game K516f attributed to Wolfgang Amadeus Mozart<sup>68</sup>

2) Although there are many bars that could be used again in a different row, each bar number is only used once in the matrix. For example, a bar from column A could have been used in column B as they are both based on the same chord but this never occurs in the composition. This was possibly done in order to ensure that enough variation is generated

<sup>68</sup> "Musikalisches Würfelspiel, K.516F (Mozart, Wolfgang Amadeus)." *Imslp.org*. Web. 9 Aug. 2017. <[http://imslp.org/wiki/Musikalisches\\_W%C3%BCrfelspiel,\\_K.516f\\_\(Mozart,\\_Wolfgang\\_Amadeus\)](http://imslp.org/wiki/Musikalisches_W%C3%BCrfelspiel,_K.516f_(Mozart,_Wolfgang_Amadeus))>.

without repeating the same motifs but more importantly this way the composer could ensure that the voice leading between each bar would be appropriate.

3) The music for each bar is written for both hands and they are always recombined together. The left hand from one bar is never recombined with the right hand from a different bar.

4) There are no dynamic or tempo markings. It is possible that these elements were left to the performer to determine but there is no such instruction in the directions.

5) A highly interesting fact can be observed in column H that corresponds to bar 8. Although there are 11 numbers corresponding to 11 different bars in the score, all of these individual bars are actually identical. This was likely done to ensure that the ending of the first phrase is appropriate as all the bars use the same cadence in G major. The same technique can also be observed in column H in the second matrix that corresponds to bar 16 in which all 11 bars are a copy of the same motif that brings the piece to a close in C major. It is odd that the composer chose to use different bars that are identical copies rather than using only one fixed number for those columns. One possible explanation is that this would have deviated from the usual format found in dice games of the time and would have required the addition of further instructions to the performer.

The aforementioned techniques employed by Mozart (or the original composer) ensured that the resulting waltz composition will be musically coherent in all of its  $11^{16}$  unique variations. To be precise this number, quoted by Cope, is not entirely accurate as I have shown that two of these bars are not truly recombinant thus making it  $11^{14}$  unique variations. Taking into consideration the fact that the harmonic progression remains identical in all recombinations

and assuming that, as there are no instructions on dynamics and tempo these remain fixed, the potential of this system to introduce significant variability between different waltzes can be questionable. However, the rationale for this composition being one of the primary inspirations for my research is that, if such an idea is applied in a gaming context, the result could be beneficial, compared to the use of identical looping. This piece was recreated in 1955 by David Caplin using the *Ferranti Mark 1\** computer in one of the earliest examples of computer music.<sup>69</sup> If we consider a hypothetical videogame from the 1980s that used such a system as its soundtrack and we compare it to the alternative of using a linear loop of the same 16 bars indefinitely then the benefits are apparent.

### **2.3 Aleatoric techniques in the 20<sup>th</sup> century**

Use of chance procedures in the generation of the musical material have been explored further by 20<sup>th</sup> century composers and are particularly prominent in the work of John Cage and Iannis Xenakis. Cage developed a technique which he referred to as “chance operations” to determine various aspects of his compositions. Inspired by the ancient Chinese book of Changes *I Ching*, in his composition *Music of Changes* (1951) he used the flip of a coin to decide on elements such as pitch, duration, and dynamics.<sup>70</sup> Similar techniques were employed in several different chance controlled compositions such as *Imaginary Landscape no.4* (1951) for 12 radio receivers, *Williams Mix* (1952) for magnetic tape, and *Winter Music* (1957) for 20 pianists.<sup>71</sup> With the aid of computer programs, Xenakis used a number of

---

<sup>69</sup> Ariza, 2011, p.47

<sup>70</sup> Griffiths, Paul. "Aleatory." *Grove Music Online. Oxford Music Online*. N.p., 2011. Web. 9 Aug. 2017. <<http://www.oxfordmusiconline.com.wam.city.ac.uk/subscriber/article/grove/music/00509>>.

<sup>71</sup> Pritchett, James. "Cage, John." *Grove Music Online. Oxford Music Online*. N.p., 2012. Web. 9 Aug. 2017. <<http://0-www.oxfordmusiconline.com.wam.city.ac.uk/subscriber/article/grove/music/A2223954>>.



advanced stochastic processes as a central feature of his work to generate elements in both a microscopic (*Mists*: 1991) and macroscopic level (*Pithoprakta*: 1955-1956).<sup>72</sup>

It is important to note that if chance procedures are only limited to the generation of the musical material themselves but the performance of the composition is itself fixed, it will have little if any value in combatting identical repetition within a gaming context. However, if all the possible outcomes of the chance procedure are available to the system before they are determined, then there is a large amount of material that can potentially provide variation. Such a process will need to be applied through the use of a music engine that runs in real-time with the game. This idea has been incorporated by a small number of experimental game composers and will be examined in chapter 3. Aleatoric composers have also chosen to introduce elements of randomness into their music not through the composition process but through the performance itself. These two approaches are not mutually exclusive as for example Cage's *Imaginary Landscape No.4* makes use of both as do many of his other compositions.

### **Open form & Mobile form**

Umberto Eco states that in order for compositions to be considered as being in “open” form, the contribution of the performer needs to extend further than traditional interpretation to the point that they are required to make autonomous decisions that impact the form of the piece itself.<sup>73</sup>

---

<sup>72</sup> Hoffmann, Peter. "Xenakis, Iannis." *Grive Music Online. Oxford Music Online*. N.p., 2016. Web. 9 Aug. 2017. <<http://0-www.oxfordmusiconline.com.wam.city.ac.uk/subscriber/article/grove/music/30654>>.

<sup>73</sup> Eco, Umberto. *The Open Work*. Cambridge: Harvard University Press, 1989, p.1

The work of Charles Ives and Henry Cowell are early 20<sup>th</sup> century examples of open form that are rarely credited by musicologists.<sup>74</sup> Cowell had developed a technique himself referred to as “elastic” form that allowed phrases to be shortened, lengthened, and connected with each other in many ways in order to accompany the evolving choreography of various theatrical pieces he wrote for Martha Graham in the 1930s.<sup>75</sup> Although dance and video games appear to be unrelated mediums it is interesting to note how Cowell faced a similar problem as present day game composers: he needed his music to be able to adapt to unpredictable changes caused by the decisions of a dancer, similarly to unpredictable changes caused by the decisions of a player.

There are many interesting usages of open form in the second half of the 20<sup>th</sup> century although not all are directly relevant to game music. In Luciano Berio’s *Sequenza I* for solo flute (1958) the pitch sequence and dynamics of the piece are fixed but the performer is free to choose the duration of each note.<sup>76 77</sup> Terry Riley’s *In C* (1964) consists of 53 phrases which each player can freely repeat as many times as she or he wishes before proceeding to the next phrase.<sup>78</sup> The lack of a clear timing in the beginning and ending of the phrases leads to indeterminate layering of the material and a similar approach was taken in the creation of the *asynchronous cells* technique in *Apotheon*.

---

<sup>74</sup> Burkholder, J. Peter. "Ives, Charles." *Grove Music Online. Oxford Music Online*. N.p., 2013. Web. 9 Aug. 2017. <<http://0-www.oxfordmusiconline.com.wam.city.ac.uk/subscriber/article/grove/music/A2252967>>.

<sup>75</sup> Burkholder, J. Peter. "Ives, Charles." *Grove Music Online. Oxford Music Online*. N.p., 2013. Web. 9 Aug. 2017. <<http://0-www.oxfordmusiconline.com.wam.city.ac.uk/subscriber/article/grove/music/A2252967>>.

<sup>76</sup> Eco, Umberto, 1989, p.1

<sup>77</sup> Osmond-Smith, David, and Ben Earle. "Berio, Luciano." *Grove Music Online. Oxford Music Online*. N.p., 2014. Web. 9 Aug. 2017. <<http://0-www.oxfordmusiconline.com.wam.city.ac.uk/subscriber/article/grove/music/02815>>.

<sup>78</sup> Strickland, Edward. "Riley, Terry." *Grove Music Online. Oxford Music Online*. Web. 9 Aug. 2017. <<http://0-www.oxfordmusiconline.com.wam.city.ac.uk/subscriber/article/grove/music/23474>>.

Stockhausen's *Klavierstück XI* (1971) consists of 19 fragments spread over a single large page. The performer may begin with any fragment, and continue to any other, proceeding through the labyrinth until a fragment has been reached for the third time, when the performance ends. What makes this piece indeterminate, and substantially different in every performance, are the decisions of the player that determine the structure and not the use of chance as in Mozart's dice games. Such aleatoric compositions in which the order of the structure is flexible are also referred to as using *mobile form*.<sup>79</sup> Similarly, in Andre Boucourechliev's series of five *Archipelagos* compositions (1967-71) performers are allowed to interpret the material in numerous ways and move freely between each "island" as well as interact with each other's musical suggestions.<sup>80</sup> Boulez's *Piano Sonata no.3* (1957) consists of five parts that may be played in several recombinations while each part consists of numerous sections that can also be recombined. Contrary to *Archipelagos* and *Klavierstück XI* where the performer is entirely free to choose the order of each section, the permitted recombinations in Boulez's sonata are subjected to strict rules that change in each section in order to ensure that the outcome, although indeterminate, remains coherent with Boulez's vision. A similar approach was taken in *Apotheon* in the *For Helen* composition in which only certain recombinations within each section are permitted while in *Village of Dion* the rules governing the recombinations changed between subsections of the level.

## 2.4 Aleatoric methods and game music

If we apply these two types of aleatoric methods to video game music, we can observe that the majority of recombinant algorithms are indeterminate because of their performance and not because of the use of stochastic methods in the compositional process. The main

---

<sup>79</sup> Alison, Latham. "Mobile Form." *The Oxford Companion to Music*. *Oxford Music Online*. Web. 9 Aug. 2017. <<http://0-www.oxfordmusiconline.com.wam.city.ac.uk/subscriber/article/opr/t114/e4463>>.

<sup>80</sup> Moore, David. "Boucourechliev: Archipels 1-4, Anarchipel." *American record guide* 58.5 (1995): 112.

difference between mobile form compositions such as Stockhausen's *Klavierstück XI* and a recombinant game algorithm is that the decisions that will shape the structure of the composition are made unintentionally by the player rather than willingly by the performing musician. The decisions of the performer of an open form piece are affected by his musical vision, but the decisions of the player are affected by the development of the game. Even if the player is conscious of the effect that her or his actions have on the structure of the music it is highly unlikely that she or he would have any interest in altering his or her course of action for the sake of musical aesthetics. Moreover, such a deviation in the player's actions would also considerably interfere with a game's design and original goals, an action only welcomed in specific types of music based games.

Another relative parallelism that can be made from aleatoric compositions in the 20<sup>th</sup> century is that between the performer of an open form piece and a recombinant algorithm. Composer John Zorn wrote a number of game pieces in the 1970s and 1980s in which performers improvised according to a set of rules that were not always written down.<sup>81</sup> When asked why he refused to publish the rules of these games he answered that "These pieces can go where anyone wants to take them, and since they live on in the underground as part of an oral/aural tradition, this becomes one of the dangers as well as part of the fun".<sup>82</sup> One of the most well-known examples of Zorn's game pieces is *Cobra* premiered in 1984 and was based on the 1977 popular WWII simulation game with the same name.<sup>83</sup> In this composition a group of improvisers request a number of musical events that are predetermined but have no particular order by using a set of hand cues that are directed towards a prompter who then relays them

---

<sup>81</sup> Brackett, John. "Some Notes On John Zorn'S Cobra." *American Music* 28.1 (2010): p. 47

<sup>82</sup> Zorn, J. quoted in Brackett, John, 2010, p.48

<sup>83</sup> Brackett, 2010, p.44.

to the entire ensemble.<sup>84</sup> As it can be seen from figure 2.2 the prompter does not determine what the improvisers play but only transmits general information such as “everything comes to a conclusion and stops”, “the volume must change radically”, “All those currently playing stop. All other play BUT IN THE SAME STYLE.”, “everyone plays sound fragments”.<sup>85</sup>

<b>Hand Signal</b>	<b>Card</b>	<b>Meaning</b>
Mouth 1	<b>POOL</b>	Start of a new section. Players may start (or not) to improvise freely. If they are continuing the style must change.
Mouth 2	<b>SOLO</b>	Start of a solo for the cued player(s). No one else plays.
Mouth 3	<b>SUB</b>	Cued players solo is taken over by another at the downbeat.
Mouth 4	<b>SUB X</b>	Cued players solo is taken over gradually by another.
Eye 1	<b>CARTOON</b>	All solos stop. Everyone plays sound fragments.
Eye 2	<b>CARTOON O</b>	Solos may continue. Everyone plays sound fragments but only on cue.
Ear 1	<b>MUSIC CHANGE</b>	Current improvisers continue to play but the musical style of their improvisation must change radically.
Ear 2	<b>GROUP CHANGE</b>	All those currently playing stop. All other play BUT IN THE SAME STYLE.
Ear 3	<b>VOLUME CHANGE</b>	The volume must change radically.
Nose 1, 2, 3...		Saves' the current section of music. Remember it and it can be recalled later. When recalled it must be played as exactly as possible.
Palm 1	<b>CUT</b>	Everything stops immediately on the downbeat.
Palm 2	<b>CODA</b>	Everything comes to a conclusion and stops.
Palm 3	<b>HOLD &amp; FADE</b>	The note or phrase is held or repeated slowly fading out.

Figure 2.2: Simplified *Cobra* performance instructions based on the *Portland Rules*.<sup>86</sup>

<sup>84</sup> Zorn, John. "COBRA." *Audio Communication Group*. Web. 9 Aug. 2017. <[https://www2.ak.tu-berlin.de/~gastprof/collins/experimental-music/Zorn/cobra\\_sheet.pdf](https://www2.ak.tu-berlin.de/~gastprof/collins/experimental-music/Zorn/cobra_sheet.pdf)>.

<sup>85</sup> Zorn, John. "COBRA." *Audio Communication Group*. Web. 9 Aug. 2017. <[https://www2.ak.tu-berlin.de/~gastprof/collins/experimental-music/Zorn/cobra\\_sheet.pdf](https://www2.ak.tu-berlin.de/~gastprof/collins/experimental-music/Zorn/cobra_sheet.pdf)>.

<sup>86</sup> Zorn, John. "COBRA." *Audio Communication Group*. Web. 9 Aug. 2017. <[https://www2.ak.tu-berlin.de/~gastprof/collins/experimental-music/Zorn/cobra\\_sheet.pdf](https://www2.ak.tu-berlin.de/~gastprof/collins/experimental-music/Zorn/cobra_sheet.pdf)>.

If such a composition is considered within a gaming context, then the role of the prompter is taken by the audio engine as it is requesting the changes within the structure of the music. The role of the improvisers that need to respond to these changes can be taken by a recombinant system. Middleware software such as Wwise can respond with a number of possible transitions between the available material (see figure 2.3). The principal difference is that a musician can use his judgment, experience, and imagination to improvise a plethora of alternative musical responses to the directions communicated by the prompter, while a system such as Wwise will always respond with a predetermined fixed transition.

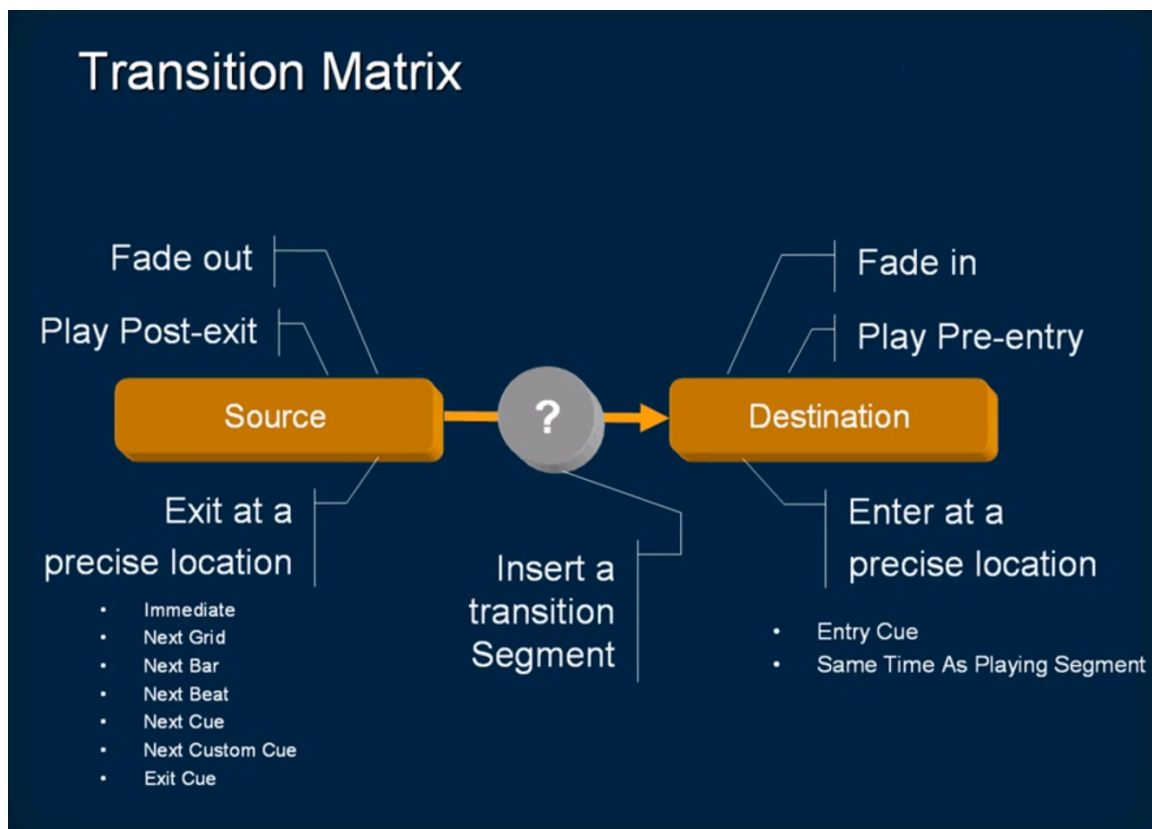

Figure 2.3: Transition Matrix in Wwise<sup>87</sup>

<sup>87</sup> "Wwise Video Tutorials." *Audiokinetic*. Web. 10 Aug. 2017. <<https://www.audiokinetic.com/resources/videos/>>.

The crucial consequences of this relationship that need to be emphasized here are that although recombinant game algorithms appear to be indeterminate, and therefore would be suitable as solutions to combat repetition and create variability, the corresponding changes that occur in the musical structure are fixed. For example, in a simple recombinant game algorithm that triggers a layer whenever a player moves past a specific point in the map, the same change in the structure will occur every single time the player performs this action. Therefore, the order and timing of musical cues might be indeterminate as they depend on unpredictable player action but since the development of the music is fixed to those actions the musical result, regardless of the specifics of the change, becomes predictable after it is experienced a few times. This can substantially intensify the problem of repetition rather than minimize it as games frequently consist of repetitive gameplay scenarios in which a player will perform an action multiple times.

Lastly, an interesting parallel needs to be drawn between open form compositions and open world games. In a macroscopic level, open world game soundtracks can be described as open form compositions as players can approach the narrative with considerable freedom resulting in multiple rearrangements of the musical soundtrack. However, as demonstrated in the *World of Warcraft* case study, progress from one area to another might take extended time periods to occur. Therefore, use of an open form is also required in a microscopic level in order to be effective, similarly to Boulez's 3rd piano sonata in which recombinations occur in each of its five main parts as well as within each part individually.

## Chapter 2 Summary

This chapter has discussed how non-stochastic recombinant techniques such as horizontal re-sequencing and vertical recombination do not necessarily assist in combating repetition. In many cases their use can make the music feel more repetitive as the underlying triggers that control the music become repetitive themselves, a problem that Huiberts has identified as a major barrier to player immersion. This might not be a problem for linear or smaller games but as Chapter 1 has shown it can be highly problematic for open world or other nonlinear, larger games. It is the use of stochastic methods in the musical structure that can truly assist in creating a recombinant score that reduces identical repetition and creates significant variations of the original material. The musical dice games found in Europe during the late 18<sup>th</sup> and early 19<sup>th</sup> centuries are some of the first examples of using chance in the generation of musical structure. Composers of the time introduced a number of methods to ensure that the resulting outcome would be stylistically coherent such as using a fixed harmonic progression, limiting the possibilities for recombination in important bars, and using chance only in one layer at a time. Composers of aleatoric pieces in the 20<sup>th</sup> century have also experimented extensively with introducing chance through the allowance of choice to performers. Similar techniques explored by Cage, Stockhausen, Boulez, Zorn, and others are applicable to game music if the role of the performer is given to the player by connecting her or his actions to multiple parts of the musical structure. In order to differentiate recombinant compositions that make use of chance in a similar way that composers of the Western Classical music tradition have done, these types of systems will be referred to as *stochastic recombinant algorithms*.



## CHAPTER 3: CASE STUDIES: GAMES THAT USED STOCHASTIC RECOMBINANT ALGORITHMS IN THEIR MUSIC

In order to assess the efficiency of stochastic recombinant techniques to reduce repetition and generate interesting variations, this chapter will analyse case studies from the history of the game industry in which composers strived to create variation by utilizing more complex recombinant techniques that incorporated the use of chance in a similar way to composers of the Western Classical music tradition. There have only been a handful of games that have employed this approach and it is worth noting that the majority of them originated during a period in which hard drive space was very limited and composers needed to discover new ways of introducing variability in their music.

### 3.1 BallBlazer<sup>88</sup>



Figure 3.1: A scan of the original cartridge of the game for the *ATARI 5200* console.<sup>89</sup>

<sup>88</sup> Developed by *Lucasfilm Games*, 1984.

<sup>89</sup> "Ballblazer (1984) (Atari-Lucasfilm Games) ROM For 5200." *Emuparadise*. Web. 19 Aug. 2017. <[https://www.emuparadise.me/Atari\\_5200\\_ROMs/Ballblazer\\_\(1984\)\\_\(Atari-Lucasfilm\\_Games\)/91726](https://www.emuparadise.me/Atari_5200_ROMs/Ballblazer_(1984)_(Atari-Lucasfilm_Games)/91726)>.

The main theme of the videogame *BallBlazer*, called “Song of the Grid”, uses what composer Peter Langston termed as the ‘riffology’ algorithm: a system that makes dynamically weighted choices for the generation of various musical parameters based on a model of human improvisation.<sup>90</sup>

The system emulates a guitar solo by choosing cells from a repertoire of 32 eight-note melodic cells and determines how fast and how loud to play them, when to omit notes, when to insert a rhythmic break, and other such musical choices with the use of weighted probabilities. In order to create a sense of development, the occurrence probabilities of the guitar solo start at a high value, are reduced near the middle of the song, and drop back to a higher value at the end. The result is that the guitar solos begin with a fast and busy texture, slowdown in the middle and pick up energy again near the ending. The solo is accompanied by a bass line, rhythm pattern, and chords which are generated and controlled by the same algorithm but using a smaller number of original cells leading to a less varied accompaniment.

Listening to a recording of music created using this algorithm (video example 3.1) we can observe that the composition does achieve the aim that Langston intended: “an infinite, non-repeating improvisation over a non-repeating, but soon familiar, accompaniment”.<sup>91</sup> The switches in the probability values as the piece evolves do indeed create a certain sense of development, especially after 2:30” where the solo has a much slower pace with longer rhythms and a more selective range of notes. Perhaps what feels the most repetitive is the accompaniment rather than the solo itself as the small amount of cells available in the

---

<sup>90</sup> Langston, Peter. "Six Techniques for Algorithmic Music Composition." Columbus: International Computer Music Conference, 1988, p.6

<sup>91</sup> Langston, Peter quoted in Collins “An Introduction to Procedural Music in Video Games.” *Contemporary Music Review* 28.1 (2009): p.11

selection pool of the algorithm quickly become familiar to the listener. Langston points out that although the final result sounds musical, it is not particularly interesting as it lacks an “appropriate structure on many levels”.<sup>92</sup>

It is noteworthy that this technique was used in *BallBlazer* because of the constraints of memory and disk space which forced the composer to attempt to generate larger amounts of music from limited musical material. Considering that the alternative option at the time was to use short compositions that would be indefinitely looped, the *Riffology* algorithm managed to create an evolving soundscape that could potentially maintain a player’s interest for longer. Langston suggested that the algorithm itself could be improved by making the program track harmonic motion in order to allow a greater variability in chord sequences, as well as use riffs of different lengths to allow for a more complex rhythmic structure.

### 3.2 Times of Lore<sup>93</sup>

The 1988 game *Times of Lore* for the Commodore 64 used a selection of guitar solos whose sequence order was selected based on random-number generators. In this way, the game’s ten songs (over thirty minutes of music) could fit into just 923 bytes. According to the composer Martin Galway, the most complex track from the game is the *Times of Lore* title track that took him 20 days to program.<sup>94</sup> Listening to this track (video example 3.2) we can observe certain resemblances to the generative algorithm of *Ballblazer*, released four years earlier. Both tracks have similar sound quality and texture, as they both imitate a guitar solo using a general MIDI synthesizer. It is interesting to note that the music from *Times of Lore* sounds

---

<sup>92</sup> Langston, Peter quoted in Collins “An Introduction to Procedural Music in Video Games.” *Contemporary Music Review* 28.1 (2009): p.11

<sup>93</sup> Developed by *Origin*, 1988.

<sup>94</sup> "Title - Times of Lore - Videogame Music Preservation Foundation." *VGMPPF*. Web. 17 Dec. 2016. <[http://www.vgmpf.com/Wiki/index.php?title=Title\\_-\\_Times\\_of\\_Lore](http://www.vgmpf.com/Wiki/index.php?title=Title_-_Times_of_Lore)>.

much closer to a traditional linear composition as the thematic material produced is more musically and stylistically coherent. Unfortunately, the composer has not disclosed much information on the exact mechanics of this algorithm; judging from the musical result it is probable that the guitar solos consisted of short pre-composed phrases that were randomized horizontally over a harmonically compatible accompaniment.

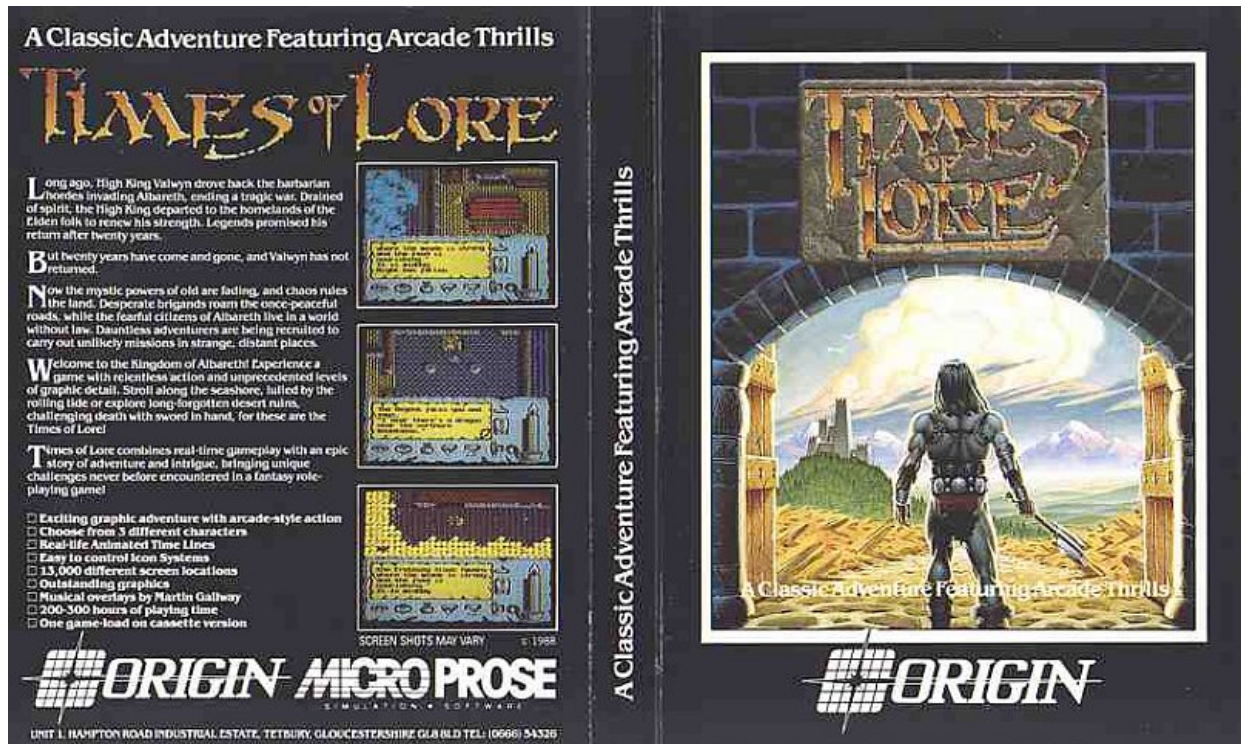

Figure 3.2: A scan of the original game cover for the console ZX Spectrum.<sup>95</sup>

### 3.3 Legend of Zelda: Ocarina of Time<sup>96</sup>

Ten years after the release of *Times of Lore*, developers had much more space than its 923 bytes. Nonetheless, the 4 MB of overall space that were available for Nintendo 64 games were not enough for composer Koji Kondo who was forced to use recombinant stochastic techniques once again. Kondo's motivation to develop his recombinant piece for the level *Hyrule Field* may come from the fact that this area was a central location in the game (see figure 3.3) that the player had to return to multiple times to gain access to other important

<sup>95</sup> "Times Of Lore." *Pix's Origin Adventures*. N.p., 2012. Web. 19 Aug. 2017.

<<http://www.pixsoriginadventures.co.uk/category/times-of-lore/>>.

<sup>96</sup> Developed by Nintendo, 1998.



gameplay areas. To avoid linear looping for such a significant location Kondo composed a series of cues that are selected based on a random-number generator. Every time the game is played, the song played during the *Hyrule Field* parts of gameplay is heard in different arrangements. By listening carefully to this music (video example 3.3) we can observe that the thematic material appears to be shifted not only horizontally but also vertically thus creating a much greater number of possible recombinations that maintain player interest and musical diversity.



Figure 3.3: *Legend of Zelda: Ocarina of Time* game map showing the central position of *Hyrule Field*.<sup>97</sup>

In addition to saving storage space and creating multiple arrangements of the main theme, the recombinant system of *Hyrule Field* can be considered as a pivotal point in generative game music as it also managed to create a popular piece of music that was very well received by

<sup>97</sup> "Legend Of Zelda: Ocarina Of Time 3D Walkthroughs." *Zelda 3DS Cheat Codes Galore*. Web. 19 Aug. 2017. <<http://zelda3ds.cheatcodesgalore.com/>>.

the fans of the *Zelda* series. The *Hyrule* theme track has almost 1 million views on YouTube, it has been remixed by several artists, there is sheet music available for it and it has been performed live by a symphony orchestra.<sup>98</sup> Judging from the commercial success and reception of the piece it is reasonable to claim that it passes Peter Langston's (the composer of *Ballblazer*) algorithmic test of "is it interesting music?". The musicality of the system can be justified by the fact that all the themes were most likely composed in a linear fashion and were later recombined to produce new arrangements rather than having to be generated algorithmically from the top down, which would have presented a significant challenge.

### 3.4 Tomb Raider: Legend<sup>99</sup>



Figure 3.4: The starting screen of the game in the console *PSP*.<sup>100</sup>

<sup>98</sup> "The Legend Of *Zelda*: Ocarina Of Time 3D." *Iwata Asks - Nintendo.com*. Web. 10 Aug. 2017. <<http://iwataasks.nintendo.com/interviews/#/3ds/zelda-ocarina-of-time/4/6>>.

<sup>99</sup> Developed by *Crystal Dynamics*, 2006.

<sup>100</sup> "Tomb Raider - Legend." *Emuparadise*. Web. 19 Aug. 2017 .

<[https://www.emuparadise.me/PSP\\_ISOs/Tomb\\_Raider\\_-\\_Legend\\_\(Europe\)/156294](https://www.emuparadise.me/PSP_ISOs/Tomb_Raider_-_Legend_(Europe)/156294)>.

In the BAFTA award winning music of *Tomb Raider: Legend* and *Tomb Raider: Anniversary* composer Troels Brun Folmann has used a recombinant technique that he invented and described as *micro-scoring*. According to Folmann “Micro-scoring is essentially about breaking the score into a variety of small components that are assembled in real-time according to player action and/or interaction.”<sup>101</sup> It is interesting to note that contrary to the previous game examples, Folmann’s motivation in developing this technique was to create a non-repetitive score. In an online interview for *Tomb Raider:Legend* he stated that “Game music has a nasty tendency to become repetitious and loop-like in its nature, so I invented the “micro-scoring” methodology to avoid this.”<sup>102</sup> Folmann mentions this technique in multiple interviews as an advancement in game composition but does not provide sufficient details on the exact mechanics of how it works. However, judging from the micro-scoring examples he discussed in his 2006 GDC lecture and by how the music engine appears to function within *Tomb Raider* (see video example 3.5), the following observations can be made:

Short micro-scores are triggered when the player approaches various places in the environment by being added on top of the currently playing music and usually lasting a few seconds. These type of micro-scores can be more accurately described as musical stingers. They either consist of short one or two note phrases or various types of instrumental effects (ex: glissandos, cymbal rolls, flutter tonguing etc) that can be easily added to the music without causing major harmonic conflicts. When the player appears to reach more important locations or events, larger micro-scores that contain longer phrases are crossfaded either horizontally or vertically but not in both directions simultaneously. In addition, judging from the music that is generated in identical gameplay situations, there does not seem to be a

---

<sup>101</sup> Folmann quoted in d'Escriván, Julio. *Music Technology (Cambridge Introductions to Music)*, 2011, p.137

<sup>102</sup> Latta, Westlee. "CDM Interview: Tomb Raider: Legend Composer Troels Brun Folmann on Adaptive "Micro-Scoring"." *CDM Create Digital Music*. N.p., 2008. Web. 9 Aug. 2017. <<http://cdm.link/2006/10/cdm-interview-tomb-raider-legend-composer-troels-brun-folmann-on-adaptive-micro-scoring/>>.

stochastic element built into each trigger. When one reaches a certain point in the game, then the same pre-defined motif will be triggered. According to Folmann, in certain cases, like when the character dies, recombinations are employed for the sake of variation. This is achieved by using horizontal or vertical crossfades between micro-cells in randomised times.<sup>103</sup>

The micro-scoring technique developed by Folmann appears to be ideal for a game such as *Tomb Raider* as it features a far more linear and fast pace development in its gameplay than an open world game. Therefore, micro-scores will be constantly triggered by player input as she or he progresses through different sections of the game resulting in a strongly adaptive experience. An average play-through of the entire game takes approximately nine hours and 24 minutes based on ten individual play times thus the four and a half hours of original music provide sufficient material to avoid repetition.<sup>104</sup> Although the benefits of micro-scoring in creating an adaptive experience are clear, it is uncertain how effective this technique would be in avoiding repetition if it were to be applied on a bigger open world game in which players might spend much longer amounts of time in the same area. In *Tomb Raider* variance is introduced by constant developments in the gameplay that are carefully planned across each level; but if the player remains static then the music does not appear to be recombined in any way. Moreover, as recombinations do not occur in horizontal and vertical directions simultaneously and as stochastic methods are not central in the generation of the structure, a much larger amount of music would be needed to avoid repetition. This issue was not evident

---

<sup>103</sup> Folmann, Troels. "Tomb Raider Legend - Scoring A Next-Generation Soundtrack". GDC lecture, 2006. Web. 14 Aug. 2017. < <http://www.gdcvault.com/play/1013234/Tomb-Raider-Legend-Scoring-a>>

<sup>104</sup> "Gamelengths - Average Play Times For Tomb Raider: Legend." *Gamelengths.com*. Web. 9 Aug. 2017. <<http://www.gamelengths.com/games/playtimes/Tomb+Raider+%3A+Legend/>>.



in *Tomb Raider* due to its linear narration and the sizable amount of original musical material compared to the length of the game.

### 3.5 Red Dead Redemption<sup>105</sup>

Another decade after *Zelda*, video games were able to use high quality recordings of big orchestral scores and MIDI had been largely abandoned. *Red Dead Redemption* is a western-action video game set in a vast open world environment that naturally requires a very large amount of music (see figure 3.5). Composers Bill Elm and Woody Jackson composed over 14 hours of music by recording several instruments typically associated with Western films and dividing them in single layers. All the pieces were written at 130 bpm and in the key of A minor for “maximum blendability and diversity of sound”.<sup>106</sup> According to the composers, “The sheer wealth of options the open world atmosphere of *Red Dead Redemption* provides ensures limitless possibilities for the diversity of its score, resulting in a decidedly authentic western atmosphere - that can change at a moment's notice.”<sup>107</sup>

---

<sup>105</sup> Developed by *Rockstar Games*, 2010

<sup>106</sup> Elm, Bill, and Woody Jackson. "Red Dead Redemption Score." Rockstar Games. Web. 9 Aug. 2017. <<http://www.rockstargames.com/reddeadredemption/features/soundtrack>>.

<sup>107</sup> Elm, Bill, and Woody Jackson. "Red Dead Redemption Score." Rockstar Games. Web. 9 Aug. 2017. <<http://www.rockstargames.com/reddeadredemption/features/soundtrack>>.



Figure 3.5: The large open world of the game set in the American West.<sup>108</sup>

What is unique about this soundtrack is that although it is a recombinant score moving across both vertical and horizontal axes similar to *Legend of Zelda*, the structural recombinations that occur are based on the player's actions rather than on the use of probabilities. As expected from the observations of the previous chapter, such an approach can produce a highly adaptive score but it can easily become repetitive because of the repetition in the underlying mechanics. However, as the recombinations in this game are occurring in both axes simultaneously, in addition to the use of a vast pool of original material and to a large number of different triggers, the structural repetition that is typically evident in non-stochastic recombinant systems is not obvious. As can be seen from the gameplay footage in video example 3.4, new material is constantly being introduced to the music from different triggers as the action unfolds: running towards the horse, arriving to *Chuparosa*, approaching the train and starting a gunfight; all trigger different recombinations and motifs which produce a strongly adaptive experience. What limits the effectiveness of this impressive

---

<sup>108</sup> "Red Dead Redemption." *IMDb*. Web. 19 Aug. 2017 .  
<[http://www.imdb.com/title/tt1479962/mediaindex?ref\\_=tt\\_mv\\_close](http://www.imdb.com/title/tt1479962/mediaindex?ref_=tt_mv_close)>.

recombinant system is the fact that an identical tempo and key of the music is used across all the layers throughout the entire game, which can become irritating in longer gameplay sessions. The use of distinct tempos and key signatures could have created a less repetitive experience and provided more contrast between the thematic material but it could have also caused difficulties in the compatibility between the cells and the flexibility of the system to adapt to a variety of situations.

### **3.6 Limitations of the stochastic recombinant algorithms used in the case studies.**

The case studies discussed above used complex recombinant algorithms effectively in order to generate new variations from pre-composed material. The most crucial difference to previous simpler recombinant systems was that cells recombined in both vertical and horizontal directions simultaneously, rather than solely in horizontal directions as in mobile forms or exclusively vertical directions as in layers. This has a significant impact on the output of a system, since using this type of recombination opens up a much greater number of possible variations from the original material. On the other hand, the use of such a tactic also raises the risk of stylistically incompatible recombinations and might create limitations to the composition of the original material. This is possibly the reason why the composers of *Red Dead Redemption* chose to write 14 hours of music in the same key and tempo.

Despite the obvious advantages of the case studies examined, there is one substantial constraint that needs to be examined. Karen Collins has questioned the capabilities of recombinant systems to generate goal-oriented music in comparison to linear music that has a clear beginning, middle, and end, and is designed to progress toward a final cadence”.<sup>109</sup> This lack of development and direction is clearly evident in the music of the games discussed with

---

<sup>109</sup> Collins, *Game Sound*, 2008, p. 158.

the exception of *Tomb Raider*. The micro-scoring technique implemented in *Tomb Raider* allows the music to closely develop with the progress of the narrative. However, this is possible because the game is relatively linear and fast-paced, and the use of stochastic methods is rare and limited to one axis. The music system in *Legend of Zelda* was not designed to create a sense of development that follows the narrative but rather to be an ever changing but familiar accompaniment to a particular static point in the game, the *Hyrule Field*. Similarly, in *Times of Lore* the variations generated are not affected at all by what is going on in the game. A crucial point that needs to be raised here is that if the structure of the music were connected to the structure of the game, then the actual development of the gameplay would have set in motion the development of the music. This is the reason why simpler adaptive techniques work effectively and this is why in *Red Dead Redemption* the music follows the action quite closely despite the openness of the narrative. What is missing for such systems to work even more efficiently is the connection between stochastic generation and specific gameplay parameters. If the probabilities of the recombinations are connected to the game structure, then the actual development of the gameplay will dictate the development of the music while avoiding the problem of underlying trigger repetition that was evident in simpler dynamic systems. This idea will be explored further in Chapter 7 using the recombinant engine of the game *Apotheon* as the principal study.

### **3.7 Why have stochastic recombinant algorithms not been used in other games?**

Apart from the games examined, this technique does not appear to have been used in other well-known games or to have been developed further. A few reasons can be considered for this lack of advancement in this technique in addition to the concerns that Collins has raised.

Firstly, since the lack of hard drive space is no longer such a big obstacle for game music, developers have chosen to use greater amounts of original music to accompany their games. There is no concrete research or statistics to be able to make precise observations but AAA higher budget games appear to include larger amount of original music than they did in the past. Russel Brower, the lead composer of the *World of Warcraft* series, recently stated that the first expansion of the *World of Warcraft* game consisted of about two hours of original music while its latest expansion includes more than seven and a half hours of original music.<sup>110</sup> Since the game proved to be such a big commercial success, Blizzard could afford to invest in a large team of composers who, including the latest expansion *Mists of Pandaria*, have now composed up to forty five hours of original music for the game with Brower claiming to have written more than 1000 compositions to accompany the game world.<sup>111</sup>

Another reason behind the absence of more stochastic recombinant systems in game music is the time commitment that is needed to create an engine that can produce meaningful results. The programming of the music of a single track in *Times of Lore* took the composer Martin Galway more than twenty days to implement into the game. My own development of such an engine for the video game *Apotheon*, which will be analysed in chapter seven, took approximately three months of full time work for the creation of only a single level. Such prolonged time commitments might prove prohibitive within the restricted production schedules of commercial titles. However, recombinant stochastic engines might be suitable for specific points in the game that are significant enough to justify the time needed to develop them. Possibly having a compositional methodology and middleware software that

---

<sup>110</sup> Russell, Brower. "The Music of Mists: An Interview with Russell Brower." *World of Warcraft*. N.p., 2016. Web. 9 Aug. 2017. <<https://worldofwarcraft.com/en-gb/news/9762739/the-music-of-mists-an-interview-with-russell-brower>>.

<sup>111</sup> Russell, Brower. "The Music of Mists: An Interview with Russell Brower." *World of Warcraft*. N.p., 2016. Web. 9 Aug. 2017. <<https://worldofwarcraft.com/en-gb/news/9762739/the-music-of-mists-an-interview-with-russell-brower>>.

can assist in the implementation of such a technique could greatly reduce the time needed to develop it. Finally, there is also the possibility that composers and developers who work in the game industry are not fully aware of the potential of such a system, as the implementation of these techniques has only appeared in a handful of academic literature examples and composer interviews to date.

### **Chapter 3 Summary**

This chapter discussed how limitations in hard drive space in the past forced composers to explore new ways of generating enough music to accompany larger games. Games such as *Ballblazer*, *Times of Lore* and *Legend of Zelda* successfully implemented stochastic algorithms that recombined smaller amount of pre-composed material in both horizontal and vertical variations. However, the absence of a connection between the musical structure and the games engines produced music that lacked a sense of direction, and more importantly did not adapt to the evolving narrative. Games such as *Tomb Raider: Legends* and *Red Dead Redemption* connected recombinations to gameplay structure but did not do so stochastically and only related to player input. While disk space restrictions diminished, the early uses of stochastic recombinant techniques were not developed further, but a number of studies have been published recently that emphasized the benefits of such an approach in game music. The next chapter will examine this research and consider how the theoretical models proposed can be utilized to improve upon the games that were examined in this chapter.

## CHAPTER 4: DEVELOPING AN EFFECTIVE STOCHASTIC RECOMBINANT ALGORITHM

### 4.1 Recombinant models by Axel Berndt et al.

The benefits of the use of stochastic recombinant forms in video game music have been discussed in a number of papers by Axel Berndt. In his paper “Composition and Arrangement Techniques for Music in Interactive Immersive Environments” Berndt proposed a recombinatory music engine which re-arranges music in real time according to gameplay parameters:

The basic principle of our music engine is the integration of musical elements into the virtual world and the re-arrangement of pre-composed musical pieces in real-time. We introduce the concept of parallel and sequential music distribution into different musical elements, which can be blended without dissonances (parallel and synchronously running elements), and meaningful self-contained musical entities, which can be re-arranged without interrupting the playback (sequential elements).<sup>112</sup>

Although there are examples of video games that make use of similar systems which precede this model (e.g. *Legend of Zelda*), there are some new ideas to be found. The idea of *Parallel Distribution*, shown in letter (b) in figure 4.1, is essentially the same thing as parallel layers, which have been used extensively by video game composers.

---

<sup>112</sup> Berndt, Axel et al. "Composition and Arrangement Techniques for Music in Interactive Immersive Environments.", 2006, p.3.

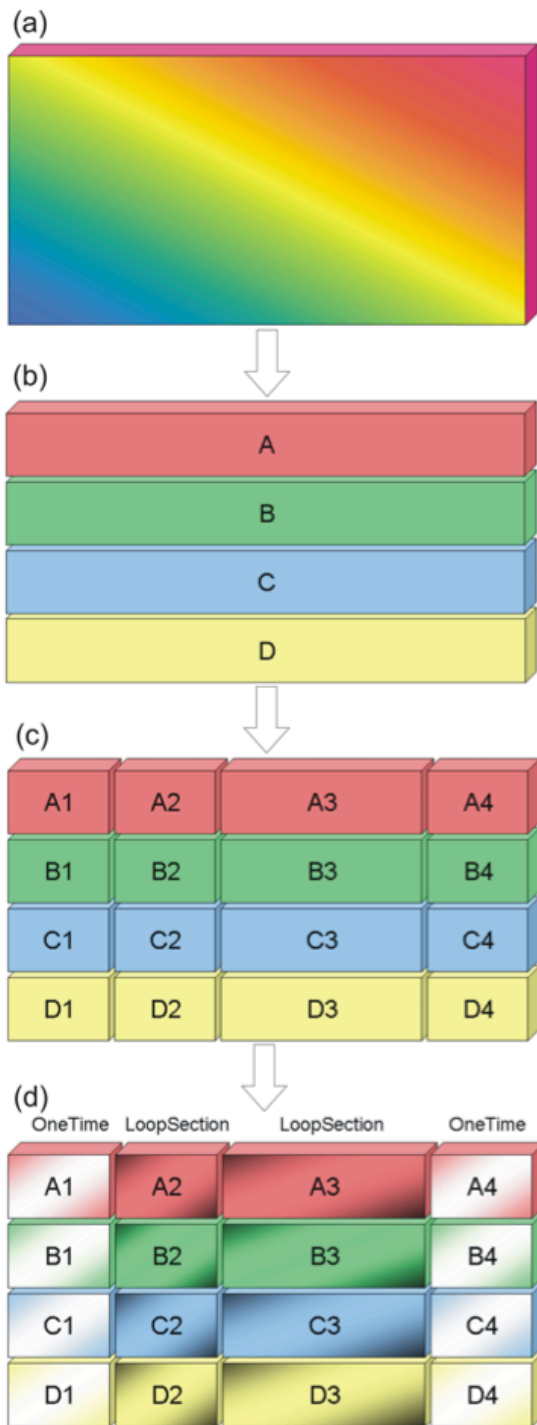

Figure 4.1: A parallel and sequential segmentation of a holistic score<sup>113</sup>

<sup>113</sup> Berndt, et al., 2006, p.3.



However, what is novel in this system is the idea of sequential block distribution.

Therefore, all pieces of music are partitioned into blocks of self-contained musical phrases which should not be interrupted to ensure musical coherency. But to achieve a real musical change, other blocks can be put into the sequence. The sequence can be adapted just in time even while the playback is running<sup>114</sup>.

Berndt proposes a system that makes use of open form in adaptive layers, but more importantly, a system where blocks are added or removed in the selection pool available to the recombinant system according to what is happening in the game. Berndt's model appears to be promising as an alternative technique to solve the problems of dynamic video game music. It is nonetheless a purely theoretical construct and there are no suggestions about how such a technique could be implemented in a real gaming environment or how it would affect the music material.

The *recombinant cells* system developed for *Apotheon* which is discussed in detail in chapter 7 of this thesis is similar to that depicted in Figure. 3.4-d, with the crucial difference that cells in one layer can be moved horizontally independently of the cells in other layers. Each layer is treated as an independent system that makes use of open form and thus opens up a vast number of further possible combinations. Figure 4.2 shows a recombinant cells model using 5 cells per layer, and 4 different independent layers. After each cell has finished playing, it can move to any cell horizontally independently of what is happening in the other layers as long as all the cells are compatible.

---

<sup>114</sup> Berndt, et al., 2006, p.4.

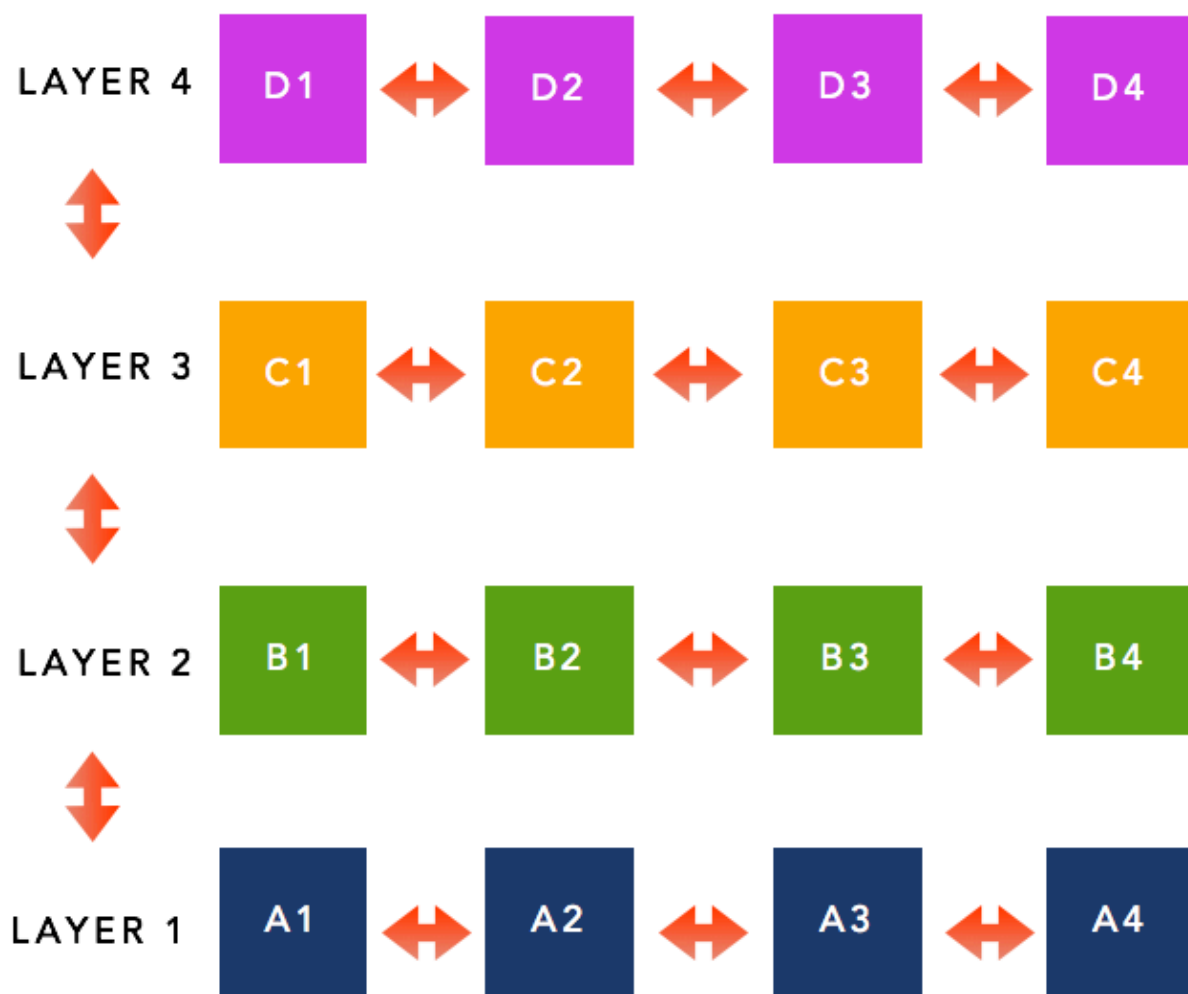

Figure 4.2: The simplest form of a recombinant cells system implemented in the first version of *Apotheon's Village of Dion*.

#### 4.2 Recombinant models by Raybould and Stevens

Raybould and Stevens have also proposed and realized multiple versions of a recombinant system that adds variation to videogame music by recombining parts of five different tracks in any direction. They mention that when the length of a piece of music is indeterminate audio designers can either fade out the music so “it does not become repetitive and lose its impact” or to develop a more complex system that adds variation through the use of controlled random processes.<sup>115</sup> Figure 4.3 below shows a graph illustrating how the principal idea

<sup>115</sup> Raybould, D., et al., 2011, p. 229.

behind their system works.

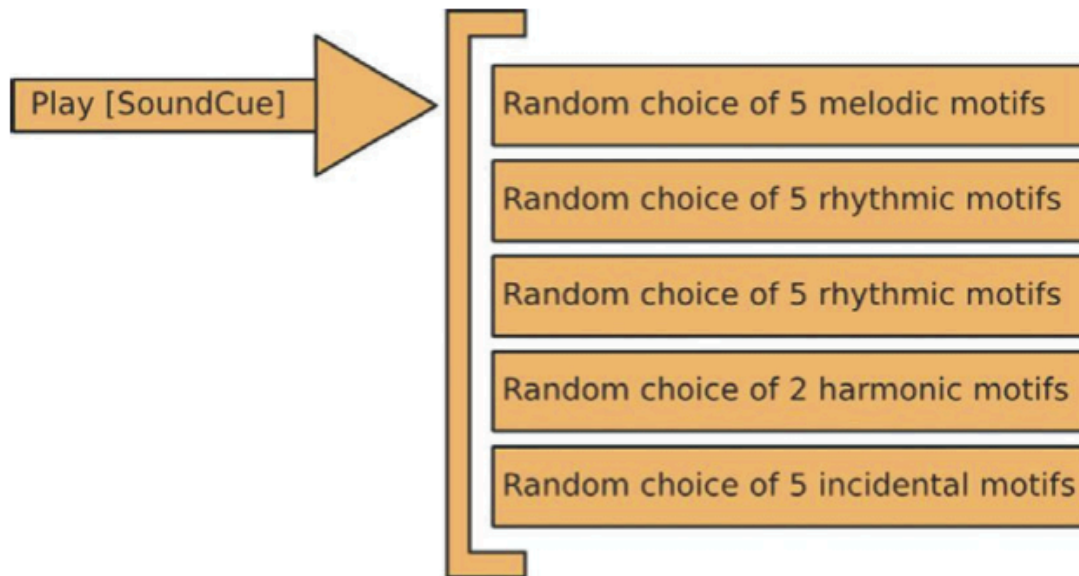

Figure 4.3: Stevens-Raybould graph of their recombinant system.<sup>116</sup>

The basis of the above model is identical to the first recombinant cells model developed for *The Village of Dion* in *Apotheon*. Both systems are based upon the same idea of using cells across multiple layers that recombine horizontally independently from each other. The first version of the Raybould & Stevens model did not offer any method of controlling which recombinations were available to the system, as all the cells had the same possibility of being selected. In their subsequent version, they have modified the system in order to address this issue. “The second version has been tweaked. Using the weightings within the **[Random]** node and by limiting the combinations available, the amount of variation has been limited but the overall effect is more musical.”<sup>117</sup>

<sup>116</sup> Raybould, D., et al., 2011, p. 229.

<sup>117</sup> Raybould, D., et al., 2011, p. 230.

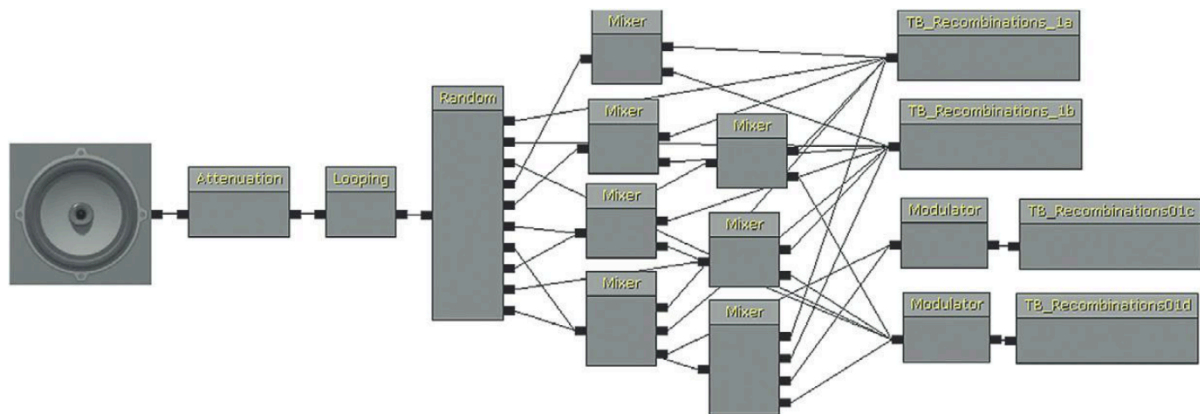

Figure 4.4: Stevens-Raybould UDK blueprint realization using a Sound Event.<sup>118</sup>

The Blueprint in figure 4.4 demonstrates how their model has been implemented in Unreal Development Kit using a Sound Event. Each layer is fed through the randomizer as well as a combination of mixers to create a range of possible recombinations for each cell.

Unfortunately, the authors do not provide any information explaining how or why certain combinations were removed from the system. Judging from the way it is constructed it can be assumed that they did so by turning the percentages of unwanted cells in the random node to 0 or by routing the signal flow to particular mixers in order to eliminate unwanted combinations. As it can be observed, layers c and d go through a modulator before going to the mixer in order to vary their volume with each recombination. The biggest drawback to this model is that, unlike the Berndt model, the system is in no way connected to the actual events that are happening during play. The authors propose another way to make such a system adaptive by using “meta controls” in order to respond to different intensity levels:

You can produce more dynamic or dramatic shapes within your music through building procedural systems that react to gameplay via “meta” overarching controls. Ideally we would be able to have a curved or variable parameter that could collate variables from the game state and then control the overall intensity level of your generative music.<sup>119</sup>

<sup>118</sup> Raybould, D., et al., 2011, p. 230.

<sup>119</sup> Raybould, D., et al., 2011, pp. 236-237.

The main idea in this model is that a parameter that calculates the amount of intensity from the game is connected to a Switch node that switches between different corresponding layers that are made out of individual recombinant subsystems. Although this type of recombinant engine is adaptive, this approach is identical to the dynamic technique of using vertical layers with the only difference that the layers are made of individual recombinant systems. The authors provide a number of highly complex Blueprints that appear promising but are difficult to decipher without the necessary accompanying clarifications or with a functional realization of this idea within UDK. I have therefore reconstructed a similar but simplified system in Unreal Engine 4, the succeeding software to UDK. In Unreal Engine 4, Sound Events have been replaced by Sound Cues but the Blueprints function the same way. Figure 4.5 demonstrates a simple two layer recombinant cells system using “meta controls” that adapts to two different intensities.

This Sound Cue consists of five cells in each layer that go through a Random node that uses weighted probabilities to select the next playing cell. Each Random node is then fed to a Looping node in order to perpetuate the process indefinitely. Each Looping node goes through a Continuous Modulator node that determines the volume of each layer according to an external intensity parameter that is controlled by the gameplay. After the volume of each layer is determined, then both signals are summed in the mixer before reaching the Output node. If a Modulator node is used in the place of the Continuous Modulator node (as in figure 4.4) then the volume of the layer will be randomized between a set range, thus creating more variation but losing any connection to the gameplay. A variation of this model closer to the Stevens and Raybould model would be to replace the Continuous Modulator node with a Switch node that could select one of the two recombinant layers according to the intensity parameter. Both of these model can provide variability through the cell recombination while

also provide a connection to the intensity of the game. As chapter 7 explores in detail, the 3<sup>rd</sup> and final engine implemented in *Apotheon's Village of Dion* expanded on Stevens and Raybould's ideas, but provided a more refined method of adapting to intensity changes by altering the weighted probabilities themselves within each layer as well as adding or removing cells from the selection pool as described by Berndt's model.

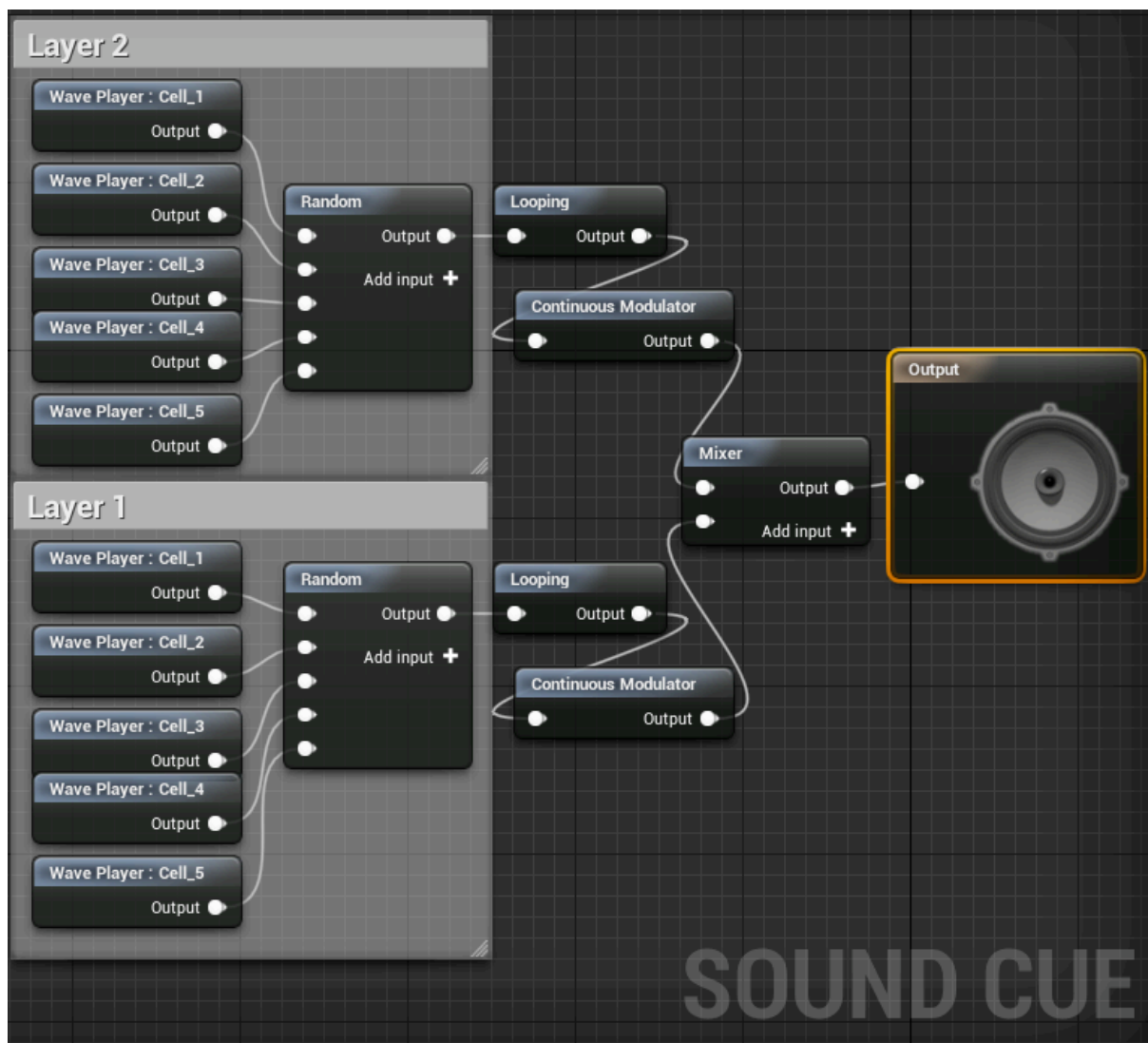

Figure 4.5: A Blueprint in UE4 inspired by Stevens and Raybould's "meta controls" recombinant model.

## Chapter 4 Summary

Axel Berndt et al. have published a number of papers highlighting the advantages of using recombinant techniques in games to reduce repetition and looping. Although many of their suggestions had already been applied in earlier games, their proposal of using a sequential block distribution to add or remove blocks from the selection pool of a recombinant engine according to gameplay action was not yet realized until it was first implemented in *Apotheon*. Stevens and Raybould have also written and recreated a stochastic recombinant system using the Unreal Engine Development Kit. Their proposed system generated variability in a score while being adaptive to the action by using meta controls that interchanged individual recombinant compositions, an idea that was also developed further and implemented in *Apotheon*. The next chapter will discuss general information on the game and musical language of *Apotheon*.

## CHAPTER 5: *APOTHEON*

This chapter provides the necessary background information on the game and soundtrack of *Apotheon* in order to assist the reader in understanding the context of the accompanying portfolio. Instructions on how to access the game are provided in section 5.4 but there are also video examples of gameplay footage in the accompanying USB for less game-friendly readers.<sup>120</sup> The overall musical language of the portfolio is discussed in sections 5.5 to 5.8 in relation to ancient Greek music and to prior games and films based on archaic themes. The accompanying portfolio is analysed in Chapter 6 for the through-composed pieces and Chapter 7 for the recombinant pieces.

### 5.1 What is *Apotheon*?

*Apotheon* is a 2D platform Action-RPG developed by the independent Canada based studio Alientrap Games and released for Steam and PlayStation 4 in February 2015. The game is set on the rich stage of ancient Greek mythology and is inspired by the artwork of ancient Greek black and red figure pottery paintings. This visual influence can be observed by comparing figures 5.1 and 5.2 that feature an original Greek example of 6<sup>th</sup> century B.C black figure painting and an example of the game's artwork designed by the lead artist Jesse McGibney.

---

<sup>120</sup> For a full list of the video examples used please refer to appendix E





Figure 5.1: Ancient Greek pottery: Achilles and Penthesilea, painted by Exekias, circa 540-30 B.C.<sup>121</sup>

<sup>121</sup> Coates, Steve. "John H. Oakley's 'Greek Vase'." *NYtimes.com*. N.p., 2013. Web. 9 Aug. 2017. <<http://www.nytimes.com/2013/12/08/books/review/john-h-oakleys-greek-vase.html>>. © Trustees of the British Museum, made available under Creative Commons Attribution-NonCommercial-ShareAlike 4.0 International (CC BY-NC-SA 4.0).

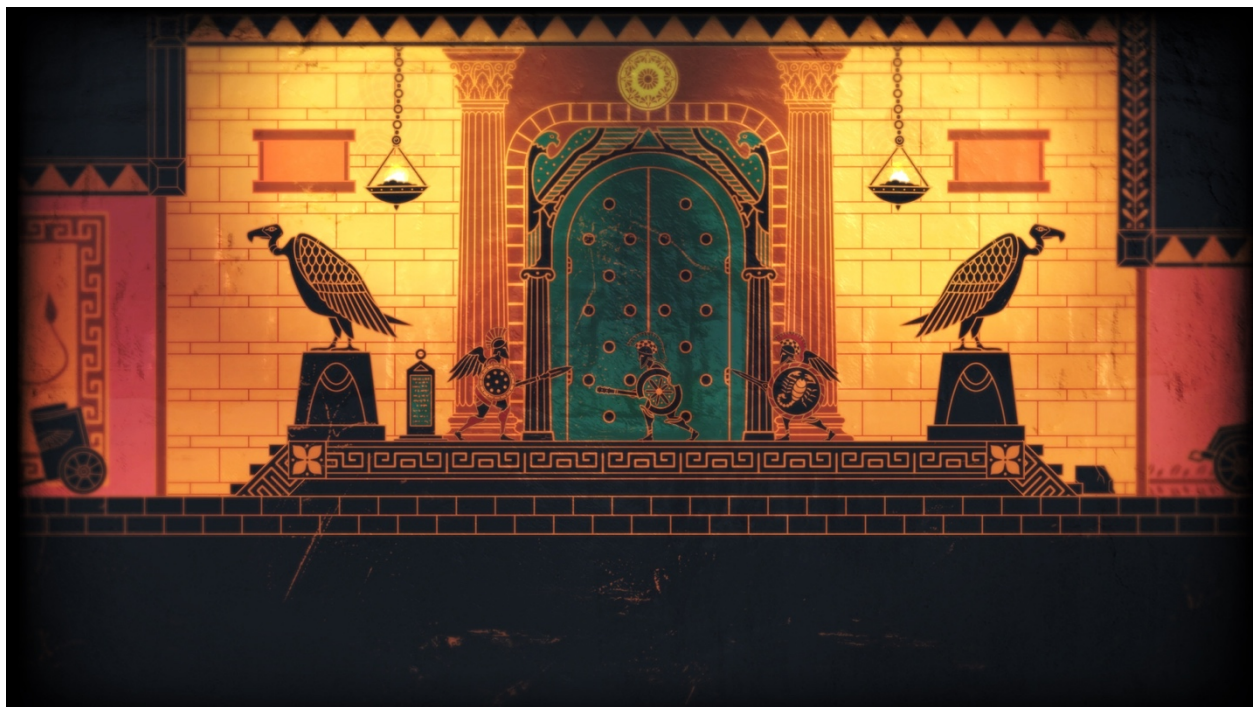
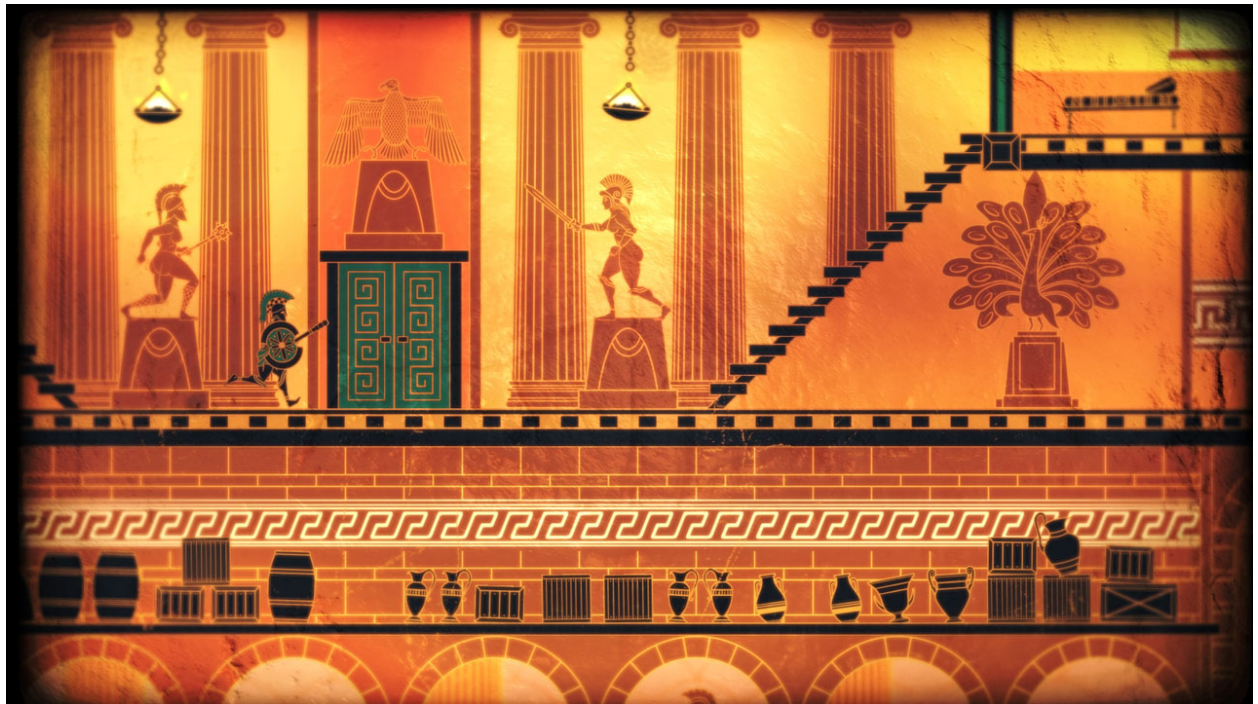

Figure 5.2: Two in-game screenshots from *Apotheon*'s Apollo's Palace designed by Jesse McGibney<sup>122</sup>

<sup>122</sup> "Apotheon on Steam." Steam, 3 Feb. 2015, <http://store.steampowered.com/app/208750/>. Accessed 17 Dec. 2016.



The name *Apotheon* comes from the ancient Greek word “ἀποθέωσις”, which means to become exalted to the state of godhood.<sup>123</sup> The player follows the quest of the main character *Nikandreos* as he faces the Olympian gods to take their divine powers for himself and ensure mankind’s survival. It features approximately 10 hours of open world single-player gameplay as well as a multiplayer mode that includes arena matches against other players. A trailer of the game with music that was generated by the recombinant cells system of *The Village of Dion* level can be found in the supporting material folder (video example 5.1).

Based on the average score of 1634 player reviews on Steam and another 15413 ratings on the official PlayStation store, the game was received with positive reviews while selling more than 150 thousand copies on Steam alone in its first year post release and being featured as one of the four games that were included with a Sony PlayStation Plus subscription.<sup>124 125</sup>

Industry reviews were generally favourable with a few outstanding ones:

The atmosphere created in tandem between the visual style and the music makes *Apotheon* one of the most captivating and stylish games in recent memory.  
9.5 – Destructoid<sup>126</sup>

During your journey, you get a pretty good notion of what's at stake through the minimalist artwork and the ominous sounds accompanying you, and you feel immersed in the two-dimensional world, eager to take on the gods and fight for mankind.  
8.5 – Softpedia<sup>127</sup>

Not only is *Apotheon* a tireless devotion to ancient Greek art and culture, it’s also a damn fun game and one of my surprise early favorites of 2015.  
9 – Game Informer<sup>128</sup>

---

<sup>123</sup> "Definition of Apotheosis (Noun, LNS, Apotheōsis)." *Latinlexicon*. Web. 9 Aug. 2017. <<http://latinlexicon.org/definition.php?p1=2003804>>.

<sup>124</sup> "Apotheon On Steam." *Steam*. N.p., 2015. Web. 17 Dec. 2016. <<http://store.steampowered.com/app/208750/>>.

<sup>125</sup> "Apotheon" *Playstation@Store*. Web. 17 Dec. 2016. <[https://store.playstation.com/#!/en-gb/games/apotheon/cid=EP4525-CUSA01366\\_00-00ApotheonFORPS4](https://store.playstation.com/#!/en-gb/games/apotheon/cid=EP4525-CUSA01366_00-00ApotheonFORPS4)>.

<sup>126</sup> "Apotheon On Steam." *Steam*. N.p., 2015. Web. 17 Dec. 2016. <<http://store.steampowered.com/app/208750/>>.

<sup>127</sup> "Apotheon On Steam." *Steam*. N.p., 2015. Web. 17 Dec. 2016. <<http://store.steampowered.com/app/208750/>>.

<sup>128</sup> "Apotheon On Steam." *Steam*. N.p., 2015. Web. 17 Dec. 2016. <<http://store.steampowered.com/app/208750/>>.

## 5.2 Advantages of using *Apotheon* as a research project.

Working on a project such as *Apotheon* gave me the advantage of being able to combine theoretical knowledge with practical research simultaneously. *Legend of Zelda* only used recombinant cells in one of its central level and *Times of Lore* was created more than 30 years ago when computing power for real time generative music was very limiting. Having the opportunity to create a stochastic recombinant model in a commercial game allowed me to observe how this type of system will behave in a real gameplay environment and to explore its capabilities and limitations to a further extent. This is an important part of this research, as the effectiveness of the system is almost entirely dependent on how well it will react to a nonlinear experience caused by the unpredictability of player interaction.

There were many advantages that made this project suitable for research. Firstly, *Alientrap Games* is a small developer team based in Toronto who were willing to experiment with new ideas and had experience creating previous successful commercial titles in 2D such as their award winning platformer *Capsized* (see figure 5.3).<sup>129</sup> The *Alientrap* team for *Apotheon* consisted of only two core members, the lead programmer and founder of the company Lee Vermeulen and the lead graphic artist Jesse McGibney with all other work done remotely by a number of freelancers. From a composer's point of view this was quite efficient because all the decisions concerning the music engine and the music could be taken jointly with the lead programmer. In many larger companies, the audio team usually consists of several members, including an audio director who would have to communicate with other departments and designers as well as the composer or team of composers, making the decision making process

---

<sup>129</sup> "Capsized - 2D Action Platform Game by Alientrap." Web. 17 Dec. 2016. <<http://www.capsizedgame.com/>>.

significantly more convoluted.<sup>130</sup> The game was play-tested throughout its development process by a number of independent players who gave feedback on the use of music in different parts of the game. The feedback was communicated to me by the developers in various stages of the development and it was taken into consideration when making changes to the music.



Figure 5.3: A gameplay screenshot from *Alientrap*'s first 2D Platform Game *Capsized*.<sup>131</sup>

The game's main engine based on Microsoft's *XNA Toolset* allowed *Alientrap* to develop and modify the engine as necessary to support my musical ideas. By having complete access to the audio engine and an experienced coder to implement my ideas, I was able to freely experiment with new recombinant techniques. Moreover, the design team approached me from the first steps of the game's creation, giving me almost three years before the game was

---

<sup>130</sup> "Interview: Blizzard Entertainment Audio Team." *Blizzard*. N.p., 2014. Web. 17 Dec. 2016. <<http://speakhertz.com/6716/interview-blizzard-entertainment-audio-team/>>.

<sup>131</sup> "Capsized." *Steam Store*. N.p., 2011. Web. 19 Aug. 2017. <http://store.steampowered.com/app/95300/Capsized/>>.

released to create a score that closely followed the story of the game while avoiding linear repetition. Lastly, the game was designed for the PC platform Steam and PlayStation 4, which meant that I had a strong platform to work on, enabling me to use considerable processing power and hard drive space for the music.

### **5.3 Praise for the *Apotheon* soundtrack**

The purpose of this section is to highlight the fact that the music of the game was well received in a commercial setting despite the fact that a large part of it was generated recombinantly. The soundtrack of the game has been received favourably from both critics and players. The complete soundtrack has been included with the supporting materials of the thesis. The opening track, *King of the Gods* that plays in the final battle with *Zeus* was nominated for the *Best Original Music Award* from the 2015 *Canadian Video Game Awards (CVA)*.<sup>132</sup>

Flattering reviews were written in key industry publications:

-Fact Magazine UK named *Apotheon* the 6<sup>th</sup> best video game soundtrack of 2015:

A large part of the game's success was down to a chilling set of cues from Greek composer Marios Aristopoulos, who captured both the era and the game's unique qualities without succumbing to the usual tropes.<sup>133</sup>

---

<sup>132</sup> "2015 Finalists - CVA" *CVA Awards*. N.p., 2015. Web. 17 Dec. 2016. <<http://www.cvawards.ca/2015-finalists/>>.

<sup>133</sup> Amin, Tayyab et al. "The 15 Best Video Game Soundtracks of 2015." *FACT*. N.p., 2015. Web. 17 Dec. 2016. <<http://www.factmag.com/2015/12/13/best-videogame-soundtracks/11/>>.

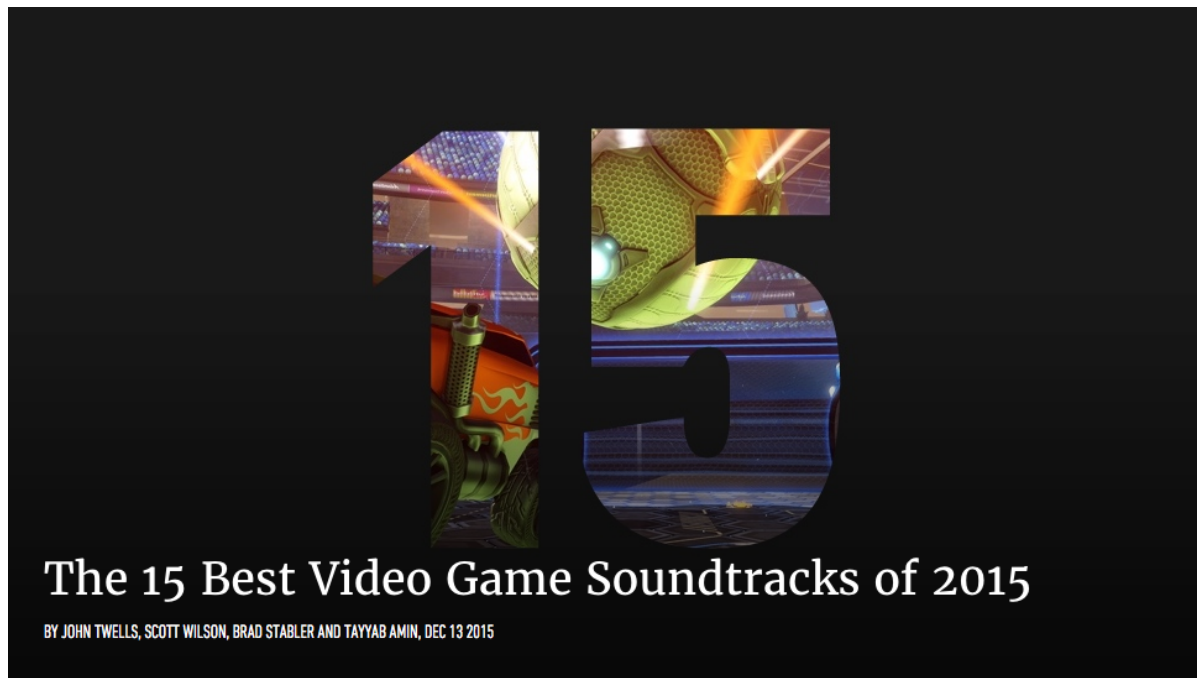

Figure 5.4: The 15 Best Video Game Soundtracks of 2015 according to Fact Magazine.<sup>134</sup>

-*PushSquare*, one of the most well-known PlayStation magazines, named *Apotheon* as the 2nd best PlayStation soundtrack of 2015 just after the blockbuster game *Assassin's Creed Syndicate*.

At the beginning of the year, Alientrap's *Apotheon* was not a game that we would have expected to have been on this list. Not because we didn't think that it would be good, but simply because we just didn't hear a whole lot about it. That all changed when it released, though, as the release delivered fun gameplay, a knockout art direction styled after ancient Greek pottery, and possibly one of the greatest soundtracks that we've ever heard. Marios Aristopoulos definitely deserves some attention for his work on this game.<sup>135</sup>

-IGR (Independent Game Reviewer) also named *Apotheon* the 6<sup>th</sup> Indie game soundtrack of 2015:

Hypnotic and foreboding, *Apotheon*'s soundtrack flares with bristling dissonance, threatening whispers and bubbling menace. A rich palette to support a wholly original and daring title.

<sup>134</sup> Amin, Tayyab et al. "The 15 Best Video Game Soundtracks of 2015." *FACT*. N.p., 2015. Web. 17 Dec. 2016. <<http://www.factmag.com/2015/12/13/best-videogame-soundtracks/11/>>.

<sup>135</sup> Banas, Graham. "Feature: The Best Playstation Soundtracks of 2015." *Push Square* N.p., 2015. Web. 17 Dec. 2016. <[http://www.pushsquare.com/news/2015/12/feature\\_the\\_best\\_playstation\\_soundtracks\\_of\\_2015](http://www.pushsquare.com/news/2015/12/feature_the_best_playstation_soundtracks_of_2015)>.

A particular standout is “Hades Underworld,” with bowed cymbals, digitally sampled sopranos, sustained drones dredging across a reticent viola chucking away the darkness as a muted churchbell tolls in the distance, warnings of a gentle piano twittering in fear.<sup>136</sup>

-Paste Magazine named *Apotheon* the 3<sup>rd</sup> best video game soundtrack of 2015.

Marios Aristopoulos really produced something special for the soundtrack to *Apotheon*, which sounds like what you’d imagine *God of War* would sound like if it were classy instead of excessively, appallingly violent. Combining dramatic orchestral work with both individual vocalists and a chorus, the soundtrack to *Apotheon* is sure to give you flashbacks to the glory days of Ray Harryhausen.<sup>137</sup>

- Full page soundtrack review of the music of *Apotheon* by the biggest selling national newspaper in Greece, *TA NEA*.<sup>138</sup>



Figure 5.5: photo of the first page and interview page of the Greek newspaper *TA NEA*

#### 5.4 Examiner guidelines on accessing the game using a PC

The game needs a relatively strong PC with at least 4 Gigabytes of RAM, 500 Megabytes of free storage, and a good graphics card that has at least 512 Megabytes of dedicated RAM.

<sup>136</sup> "Top 10 Indie Video Game Soundtracks Of 2015" *Indie Game Reviewer*. N.p., 2016. Web. 17 Dec. 2016 . <<http://indiegamereviewer.com/top-10-indie-game-soundtracks-of-2015/>>.

<sup>137</sup> "The 15 Best Videogame Soundtracks Of 2015." *Paste Magazine*. N.p., 2015. Web. 17 Dec. 2016. <<https://www.pastemagazine.com/articles/2015/12/the-15-best-videogame-soundtracks-of-2015.html?a=1>>.

<sup>138</sup> "Soundtrack for Ancient Heroes." *TA NEA*. "Soundtrack for Ancient Heroes." *TA NEA*. 3rd of May 2015: n. pag.



The game runs through Steam, a very popular gaming platform on which many PC games are released. The PS4 version is not included with the thesis as the game needs to be registered to a specific PlayStation console in order to run.

To access via Steam please follow the steps below:

1) The Steam free software should be downloaded and installed from:

<http://store.steampowered.com/about/>

2) Run steam and log in the account info fill the following details:

username: msoundtracks

password: vivaexam

3) Click on “Library” on the top section of the software

4) The current version of *Apotheon* will appear in the library and it should start downloading automatically. After the download is finished (it may take up to 30 minutes depending on your internet connection) click PLAY and enjoy!

You can skip the opening video by hitting the escape button. In order to be able to appreciate the music engine in full, I suggest turning the sound effects down to 50-60%. As will be discussed in this chapter the complete opening level of the game (*The Village*) uses a recombinant cells engine that will generate different variations of the material depending on the development of the gameplay. I suggest that when you first enter the game, you stay still for a few minutes and listen to the different variations that are created. If you are not worthy

of battling the Greek Gods you can use the cheat code: ~god to enter a god mode, while ~giveall will grant access to all the items in the game, which will make things easier! Please keep these cheat codes private as they were produced only for developers.

**IMPORTANT:** videos with footage of the gameplay are included with the thesis in order to support the writing without actually having to play the game. They can be found in the supporting material folders and will be referred to throughout the thesis.

### **5.5 Motivation for using a recombinant cells engine in *Apotheon***

As in most RPGs, the player takes control of a main character that has to go through a series of quests to reach the end of the game. The game is divided into different levels that are part of a greater open world based on an imaginary mythological representation of Mount Olympus (see figure 5.6).



Figure 5.6: A printed map of the main locations in the game taken from the collector's edition box set.

Each level in the game consists of many smaller sub areas and quests and is represented by a specific colour scheme within the game. The player can explore each level in almost any order and return to them at any given time while he or she is also given considerable freedom to choose how or when to approach quest objectives. Figure 5.7 shows a map used in the development of the game to represent the possible movement between each level. This diagram was given to me by the game developers at the start of our collaboration to help me plan the development and arrangement of the music. The blue lines indicate that the player can move freely between the connected zones at any time, while the red lines indicate that certain conditions must be met before the player can be allowed to progress in those zones.

By examining this diagram, I quickly realized that this large open world system could potentially require a lot of music to be repeated, as the time players would stay in each level was not known. In my analysis of the *World of Warcraft* music engine in Chapter 1 I showed that when players visited a particular location frequently, the constant linear repetition of the main theme had a negative effect on the player experience and a large percentage of them would choose to switch the music off.<sup>139</sup> However, I did not want to create an engine that would generate completely different results with each play through, as studies have suggested that music can be effectively used as a cue for memory in larger games.<sup>140</sup> This is especially true in an open world game, where the player may return to the same area after a long period of time and a musical theme could help them remember locations more easily and familiarize themselves more quickly with the game world.<sup>141</sup>

---

<sup>140</sup> See Kavakli, M., D, Richards, and E. Fassbender. “Game Engineering Approach to the Effect of Music on Learning in Virtual-Immersive Environments.” *Proceedings of International Conference on Games Research and Development*, 4 Dec. 2006, pp. 224–230.

<sup>141</sup> Aristopoulos, Marios. “The Role of Music in MMORPGS: An Analysis of the World of Warcraft Music Engine.” *Music and the Moving Image Conference*, Steinhardt, NYU, 2012.

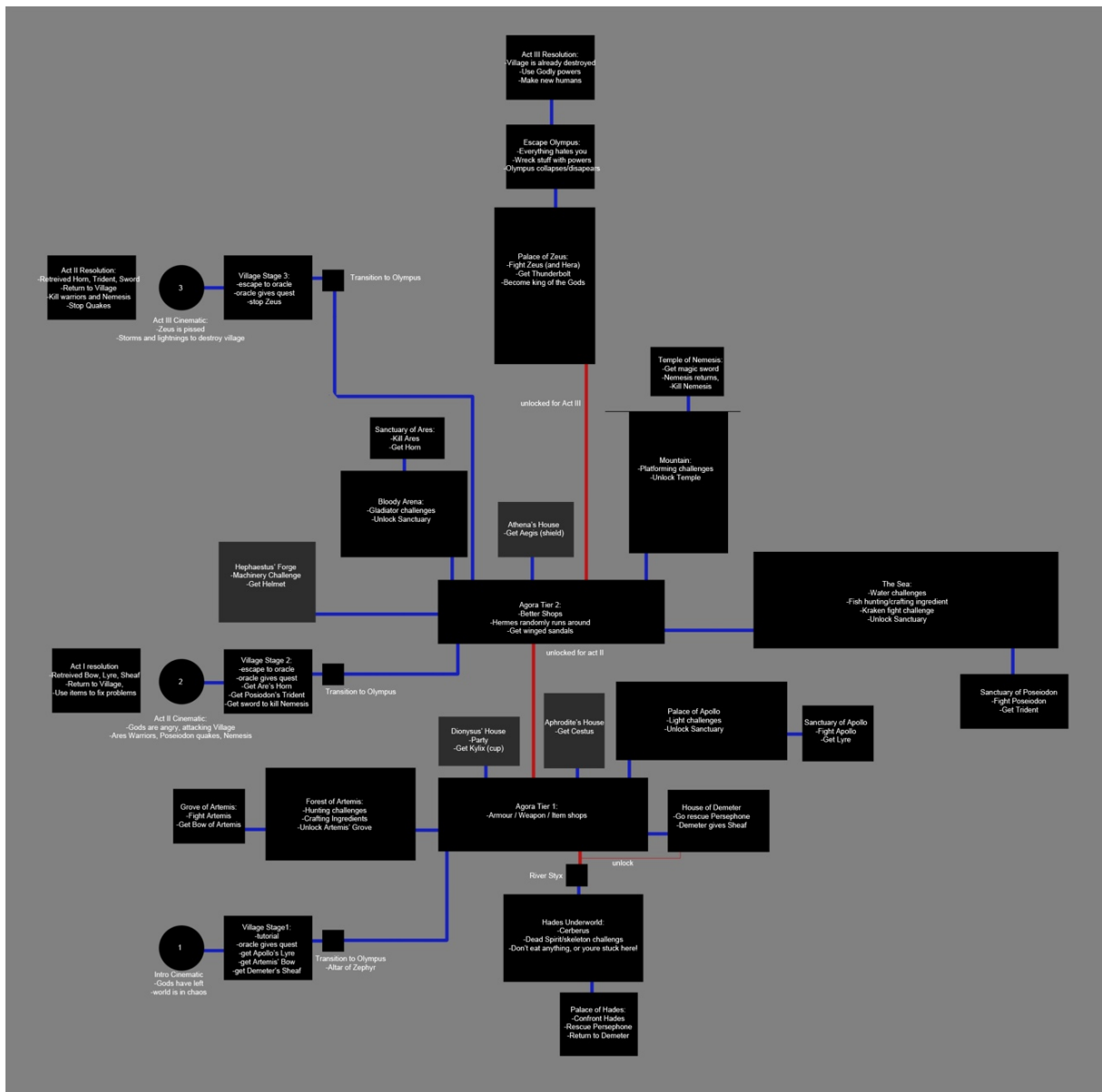

Figure 5.7: A developer’s map representing possible connections between levels in *Apotheon*. A high resolution image of this map can be found in the supporting material of the thesis.

To avoid this problem my goal was to create a music engine that reminded players of the character of each level every time they returned there while adapting to the development of the 10-hour storyline without resulting in extensive use of constant linear repetition. When I began to experiment with dynamic techniques in *Apotheon* I started researching procedural music generation and I quickly found that a stochastic recombinant system that used pre-composed musical motifs similar to the one used in *Times of Lore* and *Legend of Zelda: Ocarina of Time* could potentially be the right approach.

## 5.6 The musical language of *Apotheon*

The complete soundtrack of *Apotheon* consists of 14 through-composed and 15 recombinant compositions with a total running time of approximately 90 minutes. The music was composed in a two-and-a-half-year period between June 2012 and January 2015. The musical features and aesthetic inspiration of each piece are analysed individually in chapter 6 for the through-composed compositions and in chapter 7 for the recombinant compositions. This section will make a few general observations on the overall soundtrack and will discuss the major influences that shaped the musical language of *Apotheon*.

My intention with *Apotheon* was to compose music that was inspired by the musical information that exists from the Classical and Hellenistic periods of Greece but without attempting to recreate fully historically accurate compositions. Although this would be an interesting approach, it would not have been ideal in supporting the journey of the fictional character of Nikandros in the imaginary open world of Mount Olympus for several reasons: firstly, it would not fit the true purpose of the game. According to the official information available on *Apotheon*'s Steam page the game attempts to stay true to its source material on Greek mythology and features original extracts from the Iliad.<sup>142</sup> However, anyone with basic knowledge of Greek mythology will quickly realise that the game is far from being a historically truthful representation of the material it engages with. This is understandable as its primary purpose is to provide an entertaining narrative that is influenced by Greek mythology rather than being a strictly educational title that focuses on teaching players about ancient Greek culture. Secondly, using a musical language that is over 2500 years old to convey a range of moods and emotions to a contemporary gaming audience could be

---

<sup>142</sup> "Apotheon On Steam." *Steam*. N.p., 2015. Web. 10 Aug. 2017. <<http://store.steampowered.com/app/208750/>>.

potentially problematic. There is a strong tradition of RPG and historical game soundtracks making use of a musical vocabulary influenced by epic Hollywood movies.<sup>143</sup> It is beyond the scope of the thesis to examine this relationship but the main influences from these traditions are examined in section 5.8. A complete deviation from such a language towards an authentic recreation of alternate tunings performed on reconstructed Greek replica instruments could possibly fail to communicate the intended emotional meaning to the average player. Nonetheless, there are many elements of ancient Greek music that have influenced the music in this portfolio and are discussed in the next section.

### **5.7 Influences from ancient Greek music**

Despite the large amount of research available on the subject we do not really know how ancient Greek music actually sounded. What we know comes from research primarily based on four sources: 1) Textual: original treatises on ancient Greek music theory written in Greek, Latin and Arabic; 2) Notational: notated fragments of over 60 melodies that have survived as stone inscriptions or musical papyri; 3) Organological: surviving fragments of non-functioning ancient instruments that were found at excavation sites; and 4) Iconographic: illustrations of musical events in ancient Greek art.<sup>144</sup> However, by looking into examples of relevant literature it soon becomes evident that scholars do not always agree on their interpretation of many of these ancient artefacts. For example, according to the work of Thomas J. Mathiesen *Rhythm and Metre in Ancient Greek Music* the majority of 90 different publications on the subject of ancient Greek music written in the 1970s feature considerably inaccurate descriptions of the use of metre that do not take into consideration the original fragments of notation that have survived, nor the original texts of ancient Greek

---

<sup>143</sup> Summers, Timothy. "Video Game Music: History, Form and Genre", 2012, p.334.

<sup>144</sup> Politis, Dionysios et al. "Emulation of Ancient Greek Music Using Sound Synthesis and Historical Notation." *Computer Music Journal* 32.4 (2008), p.50

theoreticians.<sup>145</sup> Similar disputes about other elements of the music can be easily found in the work of many authors, including the original work of ancient Greek music theorists of the time that proposed multiple and often contradicting methods of tuning.<sup>146</sup> As historical accuracy was not a priority in the soundtrack of *Apotheon*, and due to the extremely broad and controversial nature of this field, it is beyond the scope of this thesis to attempt an assessment of this material.

### **Instrumentation**

According to Mathiesen et al, ancient Greek music was fundamentally vocal<sup>147</sup> a fact that is mirrored in *Apotheon* with various choral (Soprano, Alto, Tenor, Baritone, Bass) and soloist combinations singing either vocalizations or Ancient Greek text written by myself using he Wordbuilder software (discussed in more detail in 6.1). According to the Hornbostel-Sachs classification, ancient Greek instruments fall into four categories: idiophones, membranophones, aerophones and chordophones.<sup>148</sup> Common instruments from these categories were mirrored in *Apotheon* after listening to the sonic colour of modern replica recreations and choosing similar sounding traditional instruments from a wide variety of musical cultures. Some of these instrumental colours were exaggerated to fit the dramatic context of a videogame soundtrack. The table in figure 5.8 demonstrates some of the instrumental associations that were made in the game:

---

<sup>145</sup> Mathiesen, Thomas J. "Rhythm and Meter in Ancient Greek Music." *Music Theory Spectrum* 7 (1985), p.159.

<sup>146</sup> Politis, Dionysios et al., 2008, p.50

<sup>147</sup> Mathiesen, Thomas. "Ancient Greek Music." *The Oxford Companion to Music. Oxford Music Online*. Web. 9 Aug. 2017. <<http://0-www.oxfordmusiconline.com.wam.city.ac.uk/subscriber/article/opr/t114/e260>>.

<sup>148</sup> Mathiesen, Thomas. "Ancient Greek Music." *The Oxford Companion to Music. Oxford Music Online*. Web. 9 Aug. 2017. <<http://0-www.oxfordmusiconline.com.wam.city.ac.uk/subscriber/article/opr/t114/e260>>.



<b>Ancient Greek Instrument</b>	<b>Association with contemporary equivalent</b>
<b>Idiophones and membranophones</b>	
<i>Tympanum</i> , an ancient hand drum of approximately 30 cm in diameter	Roman War Drums and Taiko drums
<i>Sistrum</i>	Shaker
<i>Cymbala</i>	Finger cymbals
<i>Rhombos</i> , a piece of wood whirled around on a string producing a nasal buzzing sound.	Brazilian Berimbau
<i>Rhoptron</i>	Tambourine
<i>Crotala</i>	Castanets
<b>Aerophones</b>	
<i>Aulos</i> , one of the most common ancient Greek wind instruments, double reed	Duduk
<i>Syrinx</i> , high pitched panpipes	Ney high pitched – the only wind instrument in the classical Persian orchestra
<i>Saplinx</i> and <i>keras</i> , bronze and iron instrument used in battle to provide military signals	French Horns
<b>Chordophones</b>	
<i>Lyre</i> , a common small harp usually plucked by fingers	Orchestral harp
<i>Psalteria</i> , type of lyre with large number of strings (up to 32)	Oud
<i>Kithara</i> , lyre with wooden soundboard	Nylon based guitar
<i>Phorminx</i> , a type of ancient harp similar to the kithara played with a plectrum	Middle eastern Qanun, also played with a plectrum

Figure 5.8: Some of the instrumental associations made in *Apotheon*.<sup>149</sup>

## Performance and Production

Most of the above instruments were reproduced by using virtual instruments based on the following East West and Quantum Leap libraries: *Symphonic Orchestra Platinum Plus Edition* (194 GB of orchestral samples), *Symphonic Choirs, RA, Voices of Passion, Silk, Storm Drum 2, Storm Drum 3*, and *Goliath*. All of the MIDI arrangements were built by performing individual passages on four different MIDI keyboards/controllers (synth action,

<sup>149</sup> The instrumental descriptions and classification of ancient Greek instruments are based on Mathiesen, Thomas. "Ancient Greek Music." *The Oxford Companion to Music*. *Oxford Music Online*. Web. 9 Aug. 2017. <<http://0-www.oxfordmusiconline.com.wam.city.ac.uk/subscriber/article/opr/t114/e260>>.

semi weighted, hammer weighted and drum pads) according to the velocity sensitivity preferred for each virtual instrument. In order to achieve more natural performances MIDI quantization and editing was rarely used and passages were re-recorded numerous times until a satisfactory and coherent performance was achieved. The music was produced using Logic Pro for the MIDI arranging and recording and Pro Tools for the audio mixing. The only audio recordings in the soundtrack were the solo guitar piece *Road to Troy* performed by myself and the female vocals that appear on the recombinant cells of *Village of Dion* and *The Oracle*. The vocals were performed by the Spanish artist Xana Bel and were recorded in New York City by sound engineer Emilio Garzon.

## **Metre**

According to the work of M.L. West, ancient Greek music often featured complex and varied use of irregular metre, a component that is used regularly in *Apotheon*.<sup>150</sup> His research was based on observing patterns of long and short syllables on verse texts that were meant to be sung or danced to as well as interpreting surviving notation and original treatises from ancient Greek authors. West mentions that in addition to simpler metres, Greek music regularly used the following patterns that are also mirrored in *Apotheon*:

- 1) *Iambic* meter that corresponds to  $6/8$ <sup>151</sup>
- 2) *Dochmiac* metre that corresponds to counts of  $3+5$ <sup>152</sup>
- 3) *Paeonic* meter that was mentioned in treatises by Aristotle and Aristoxenus and corresponds to  $5/8$ <sup>153</sup>
- 4) Juxtapositions of multiple metre in the same piece (see figure 5.9).

---

<sup>150</sup> West, M. L. *Ancient Greek Music*. Clarendon Press, 1992, pp 129-159.

<sup>151</sup> West, M. L., 1992, p.137.

<sup>152</sup> West, M. L., 1992, p.137.

<sup>153</sup> West, M. L., 1992, p.140.

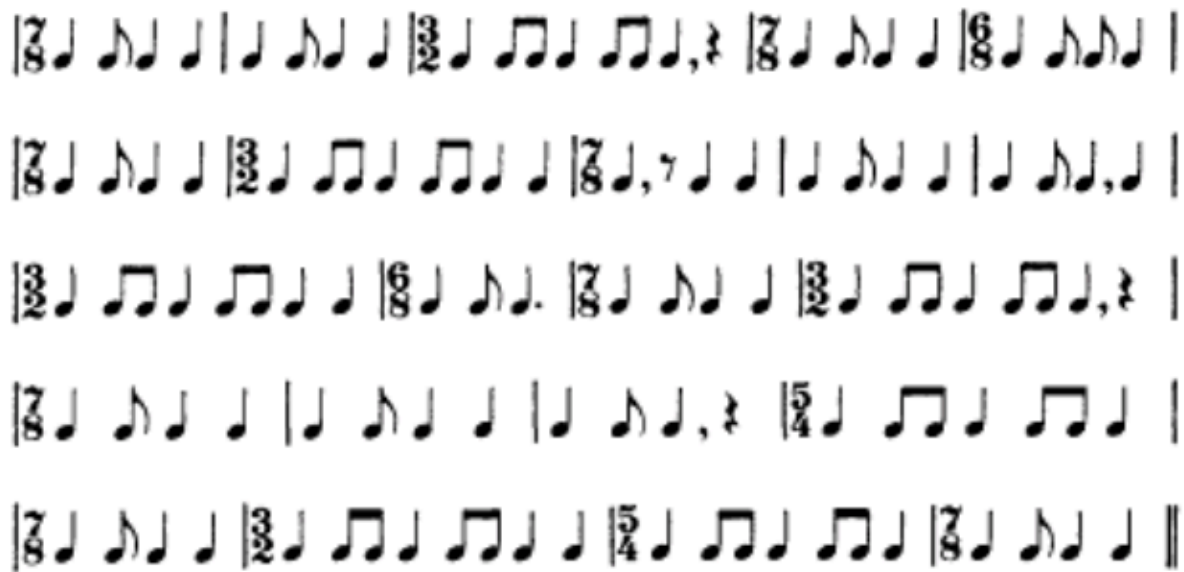

Figure 5.9: M.L. West's rhythmical analysis of the strophe of Pindar's *First Pythian Ode*.<sup>154</sup>

## Scales

A number of ancient Greek theoreticians distinguish between several tuning systems that do not correspond to those of the tempered scale.<sup>155</sup> Aristoxenus's highly complex treatise *On Harmonics*, one of the oldest surviving works of Greek music theory, features a set of theorems setting out the laws of harmonics. According to Aristoxenus the interval of a perfect 4<sup>th</sup> can be divided in three types of tetrachords (group of four notes): the enharmonic (two tones, followed by two quarter tones), the chromatic (a tone and a half, followed by two consecutive semitones), and the diatonic (a tone, tone, semitone)<sup>156</sup>. Also according to an analysis of 2200 note successions, contemporary author West concludes that "The fact is that conjunct or stepwise motion is what predominates in Greek music".<sup>157</sup> The music in

<sup>154</sup> West, M. L., 1992, p.152.

<sup>155</sup> West, M. L., 1992, pp.166-167.

<sup>156</sup> Bélis, Annie. "Aristoxenus." *Grove Music Online. Oxford Music Online*. Web. 9 Aug. 2017. <<http://0-www.oxfordmusiconline.com.wam.city.ac.uk/subscriber/article/grove/music/01248>>.

<sup>157</sup> <sup>157</sup> West, M. L., 1992, p.191

*Apotheon* is loosely inspired by those concepts; it frequently implements stepwise motion with chromaticism and various non-diatonic scales such as the half step whole step octatonic scale, the double harmonic scale, and the dominant Phrygian (Hijaz) scale as well as making use of modal inflections.

## 5.8 Influences from video games and films with Ancient Greek music

Prior to composing the music for *Apotheon* I researched the music of a number of former video games and films that incorporated themes from Ancient Greek history and mythology. The majority of them did not utilize historically accurate music, possibly for reasons similar to the ones discussed in the previous section, but my interest was in examining how composers represented ancient Greek elements to a contemporary film and gaming audience. The earliest game example found is the 1986 NES game *Kid Icarus* by Nintendo in which the player faces Medusa in a fantasy world of *Angel Land* inspired by Greek mythology.<sup>158</sup> The soundtrack composed by Horokazu Tanaka was limited to an 8 bit instrumental palette but the heroic and memorable themes frequently implemented harmonic minor, chromatic and whole tone scales.<sup>159, 160</sup> A more recent example is *Age of Mythology* released in 2002 that was inspired by a combination of Greek, Egyptian and Norse mythologies. The score was written by Stephen Rippy and Kevin McMullan for a seventy-piece orchestra and featured instruments such as ney, tabla and oud with a view to creating a more authentic atmosphere.<sup>161</sup> One of the most well-known and commercially successful franchises based

---

<sup>158</sup> "10 Games About Ancient Greece." *IGN Boards*. N.p., 2009. Web. 9 Aug. 2017. <<http://www.ign.com/boards/threads/10-games-about-ancient-greece.187605563/>>.

<sup>159</sup> "Kid Icarus (1986) NES Review - Mobygames." *MobyGames*. N.p., 2006. Web. 9 Aug. 2017. <<http://www.mobygames.com/game/nes/kid-icarus/reviews/reviewerId,44055/>>.

<sup>160</sup> McFerran, Damien. "Review: Kid Icarus (NES)." *Nintendo Life*. N.p., 2007. Web. 9 Aug. 2017. <[http://www.nintendolife.com/reviews/vc/kid\\_icarus\\_nes](http://www.nintendolife.com/reviews/vc/kid_icarus_nes)>.

<sup>161</sup> Butts, Steve. "Age of Music - IGN." *IGN*. N.p., 2002. Web. 9 Aug. 2017. <<http://uk.ign.com/articles/2002/09/06/age-of-music-2>>.

entirely on Greek mythology was the *God of War* series that begun in 2005 with *God of War* for PlayStation 2 and has since continued with six more titles by different developers and teams of well-known composers. The original title featured the work of six composers who created an epic orchestral based score that also incorporated heavy use of sampled choirs and a small number of world instruments such as gongs, tabla, and oud.<sup>162</sup>

Tyler Bates's soundtrack of *Rise of the Argonauts* (2008: Liquid Entertainment) relied less on the sound of the orchestra and instead made extensive use of ethnic instrumentation and ethereal vocals as well as frequent use of harmonic minor scales. Two years before the release of this game, Bates composed music in a similar style for the 2006 Hollywood film *300* that was based on Frank Miller's comic series on King Leonidas of Sparta and the battle of Thermopylae. Bates's music for *300* differs from *Rise of the Argonauts* as, in addition to the ethnic components, he also incorporated elements such as electric guitars, synthesizers, and a massive male choir in order to fit the pop aesthetic of Frank Miller's artwork. Bates's work for both soundtracks was an inspiration for *Apotheon* mainly because of its limited dependence on a full orchestral sound and the emphasis given on the use of a large choir, ethnic instrumentation and frequent use of irregular metre.

The Oscar winning soundtrack of the film *Gladiator* (2000) by Lisa Gerard and Hans Zimmer was also one of the major film musical influences of *Apotheon*. The vocals of Lisa Gerard on the tracks *Elysium* and *The Battle* were given as a musical reference to Xana Bel who sung in the track *The Orcale* for the *Apotheon* Soundtrack. Also the motivic development of the composition *The Battle* was used as an influence on the battle track *For Helen* in *Apotheon*. The soundtrack also featured elaborate passages of solo duduk which

---

<sup>162</sup> The instrumentation was based on listening to the OST

were accompanied by string pedal notes and guitar arpeggios, a sound that I found deeply influential and integrated it frequently in *Apotheon*. The soundtrack of the video game *Rome Total War* by Jeff van Dyck also made use of duduk and ethereal vocalizations in a similar style as *Gladiator* and the track *Divinitus* was another influence on my work.

A major influence predating all of these examples came from Bernard Herrmann's 1963 score for the film *Jason and the Argonauts*, which set an early reference for ancient Greek scenery for film and game composers (figure 5.10). Herrmann used dissonant harmonies with frequent use of diminished chords and chromatic movement, harmonic minor scales, percussion based themes and extended use of harp passages. Moreover, in contrast to his all-string score for *Psycho* he dismissed the string section entirely but quadrupled the wind and brass sections as well as using a huge percussion section consisting of 26 instruments.



Figure 5.10: A scene from the movie *Jason and the Argonauts*. A similar theme of the hero fighting against a mythological skeleton army occurs in the *Hades* level in *Apotheon*.<sup>163</sup>

<sup>163</sup> “Todd Armstrong in Jason And The Argonauts (1963).” IMDb. N.p., Web. 9 Aug. 2017. <<http://www.imdb.com/title/tt0057197/mediaviewer/rm749869312>>.

My work on *Apotheon* was also influenced by other game composers whose music is not related to ancient Greece but features a similar musical language. The use of long drones, ethereal vocals, harp, and heavy percussion in *Apotheon*'s ambient tracks *Ten Years of War* and *Trojan Shores* was inspired by the work of Knut Avenstrup Huagen for the MMORPG *Age of Conan: Hyborian Adventures* and especially the track *Ere the World Crumbles*. The combination of melancholic solo melodies and epic brass arrangements found in Inon Zur's main theme in *Dragon Age: Origins* was also mirrored in many points in *Apotheon*. Finally, the extensive use of delay found in many pieces in my work was inspired by Matt Uelmen's 12 string guitar theme from *Diablo's Tristram Village*.

## Chapter 5 Summary

*Apotheon* is 2D platform game released in 2015 for PS4 and Steam by the independent Canadian studio *Alientrap*. The game consists of a storyline of approximately 10 hours set in an imaginary open world Mount Olympus inspired by ancient Greek mythology and art. The soundtrack consists of 29 compositions and was very well received by press and fans. The nature of the collaboration with *Alientrap*'s game designers provided me with the time, technical support, and freedom to experiment with recombinant techniques and elements of ancient Greek music for a period of two and a half years which resulted in the co-creation of a custom made recombinant system for the game. The musical language of the portfolio is not meant to be historically accurate but is inspired by research on relative literature on ancient Greek musical characteristics especially on the use of irregular metre, use of traditional instrumentation, and use of scales. Musical influences from earlier games came from the work of composers such as Knut Avenstrup Huage (*Age of Conan*), Inon Zur (*Dragon Age*), and Matt Uelmen (*Diablo*). Film score influences came from the work of Hans Zimmer and Lisa Gerrard (*Gladiator*), Tayler Bates (*300*) and Bernard Herrmann (*Jason and the Argonauts*). Further details on each individual composition of the accompanying portfolio will be given in the next two chapters.



## CHAPTER 6: THROUGH-COMPOSED PIECES IN *APOTHEON*

This chapter will discuss the compositions implemented in the game that did not make use of recombinant methods but were intentionally through-composed. Although each of these pieces was composed in a linear fashion they were all written in order to function as a part of a larger recombinant structure. Therefore, factors such as key, instrumentation, tempo and intensity were taken into consideration during the compositional process to ensure that possible connections to other tracks were stylistically appropriate. The purpose of this section is to provide further information on the musical features of each piece and examine their relationship to the game's overall narrative. Moreover, the reasons why certain pieces were through-composed and not recombinant will also be examined.

### 6.1 *King of the Gods*<sup>164</sup>

This is the most commercially successful track from the entire *Apotheon* soundtrack album both in terms of iTunes and Amazon sales and in terms of highest number of plays in Spotify and YouTube. It is also the track that was nominated for the Best Original Music of 2015 award from the Canadian Video Game Awards and was chosen by *Alientrap* as the main theme to accompany the game's official PS4 launch trailer.<sup>165</sup> Inside the game, this music appears only in the final stages of the game when the player needs to defeat Zeus in order to achieve his apotheosis and become a god himself. To accompany this climactic moment in the narrative, I wanted to create a composition that was as epic as possible without moving away from the aesthetics of the rest of the soundtrack.

---

<sup>164</sup> Audio example 01

<sup>165</sup> "2015 Finalists - CVA" *CVA Awards*. N.p., 2015. Web. 17 Dec. 2016. <<http://www.cvawards.ca/2015-finalists/>>.

The musical inspiration for this piece came from multiple compositions. The key of C# minor was inspired by Beethoven's first movement of his Moonlight Sonata and is a key that I prefer to reserve for my most dramatic compositions. The idea of using only a full all-male choir to state the main theme before embellishing the arrangement with heavy percussion and brass came from *Return of a King* by Tyler Bates from the movie *300*. Another major influence particularly in the use of longer notes in the choir which are juxtaposed by fast staccato motifs in the rest of the orchestra came from *Duel of the Fates* by John Williams from *Star Wars Episode I – The Phantom Menace*.

Although many compositions in the game share an epic aesthetic, extensive use of choirs is reserved only for the 4 tracks that accompany battles with the Olympian Gods: *King of the Gods*, *Apollo's Palace*, *March from Hades*, and *Achilles Heel*.

In order to build a choir sound that would be as large as possible, 12 instances (as many as the Gods) of *East West's Symphonic Choirs* virtual instrument were layered simultaneously. The MIDI data was triggered through the *WordBuilder* plugin which allows users to type in syllables for the Choir to sing (see figure 6.2). The lyrics in all of the choir compositions were written by myself in ancient Greek and were inspired from various poems of ancient Greek mythology such as Homer's *Odyssey* and *Iliad*. Sometimes, gibberish words were chosen only for their acoustic resonance rather than their meaning but in *King of the Gods* there is a clear reference to the story of the Titans, who were the previous rulers of the world before being overthrown by Zeus. The text for the first two lines of the track can be approximately translated in English as "Titans!, Titans!, Apotheosis, Oceanus, Hyperion, Titans! Titans!".



Figure 6.2: The text sung by the choir in *King of the Gods*, written in separate syllables using *WordBuilder*

As this is a short but crucial battle that only occurs once in the game, I preferred to use a looped linear piece in order to have maximum control over the development of the music. The composition is structured around two themes; the main theme in 7/4 and a secondary theme that follows in 7/8. As the piece develops there is a constant build-up in the arrangement with additional instrumental layers added to enhance the tension. The energy and texture are then intentionally reduced during the ending in order to create sufficient contrast for when the piece loops. The instrumentation consists of an all-male choir of three sections (basses, baritones and tenors), a full brass section, multiple percussion layers which

were heavily processed with EQ and parallel compression to enhance the low end as much as possible, a solo oud, a solo qanun and a full string section.

## **6.2 *March from Hades*<sup>166</sup>**

*March from Hades* is a theme that is used a sound symbol to accompany all the battle scenes in the game against Giants and Cyclopes. To establish a sense of awe and danger as the player suddenly faces an enormous giant in front of him (similar to figure 6.3) the composition starts immediately with a fortissimo male choir doubled with sforzando trombones and answered by a huge ōdaiko drum hit imitating a heartbeat. The piece uses a tempo of 100 and repeats in a cyclical form of a six crotchet bar followed by a four crotchet bar. Huge anvils hits emphasize beats one, three, and five, imitating the slow footsteps of the giant. The overall mood is epic but darker than most of the other pieces, in order to reflect a battle against impossible odds in which victory is not guaranteed. Female ethereal vocalizations are added towards the middle of the piece that are reminiscent of the oracle motifs in the *Village of Dion* and provide a sense of hope within an atmosphere of despair.

## **6.3 *Apollo's Palace*<sup>167</sup>**

Although this composition is titled *Apollo's Palace* it only plays after the player has managed to escape Apollo's dungeon and defeat the cyclops *Brontes* (see figure 6.3). This is the most heroic theme of the soundtrack and it is used as a reward to celebrate the player's achievements with a memorable brass based theme. It is also used in other places in the game to highlight moments of bravery such as after the player completes *the Maze of Athena* and embarks on the *Siege of Heroes* quest.

---

<sup>166</sup> Audio example 08

<sup>167</sup> Audio example 06



Figure 6.3: Gameplay screenshot from the battle between *Nikandreos* and the cyclops *Brontes*

This is the only battle piece in the game that is entirely based on 4/4. The composition begins with a short introduction of an A minor ostinato played by the strings that continues throughout the piece regardless of the chord changes. The main theme that follows is based on a cyclical form of an eight bar harmonic progression. The first phrase; i – VI – iv – VII (A minor, F major, D minor, G major) implies a transition to the relative major but in the second phrase the VII chord is replaced by the dominant V (E major) before returning to the ostinato and preparing the piece for a seamless loop.

This composition was fully transcribed for the Frisco High School Orchestra (figure 6.4). The transcription occurred after a high school student from Texas who was a fan of the game kindly requested a copy of the music for his school's end of the year concert. A full score is available in appendix C.

The image displays a musical score for the main theme of *Apollo's Palace*, written in concert pitch. The score is divided into three systems, with measures 22, 28, and 33 marked as section markers C, C, and D respectively.

**System 1 (Measures 22-27):** This system includes parts for Tbn., Cym., Vln. I, Vln. II, Vla., Vc., and Db. The Tbn. part begins with a forte (*f*) dynamic. The strings (Vln. I, Vln. II, Vla., Vc., Db.) play a rhythmic pattern of eighth notes, often in groups of three, with a forte (*f*) dynamic. The Cym. part is marked with a forte (*f*) dynamic.

**System 2 (Measures 28-32):** This system includes parts for Hn., Tbn., Timp., Cym., Vln. I, Vln. II, Vla., Vc., and Db. The Hn. part enters with a forte (*ff*) dynamic. The Tbn. part continues with a forte (*ff*) dynamic. The Timp. part plays a rhythmic pattern marked with a mezzo-forte (*mf*) dynamic. The Cym. part is marked with a piano (*p*) dynamic. The strings (Vln. I, Vln. II, Vla., Vc., Db.) continue with their rhythmic pattern, marked with a forte (*ff*) dynamic.

**System 3 (Measures 33-36):** This system includes parts for Hn., Timp., Cym., Vln. I, Vln. II, Vla., Vc., and Db. The Hn. part continues with a forte (*f*) dynamic. The Timp. part continues with its rhythmic pattern. The Cym. part is marked with a piano (*p*) dynamic. The strings (Vln. I, Vln. II, Vla., Vc., Db.) continue with their rhythmic pattern, marked with a forte (*f*) dynamic.

Figure 6.4: The main theme of *Apollo's Palace* written in concert pitch. The full score can be found in appendix C

#### **6.4 *Achilles Heel*<sup>168</sup>**

This is one of the choir based tracks that is used to accompany major battles with the gods and it is played during the fight with Ares and Apollo. The piece has a fast tempo of 166 crotchets per minute and begins with an ostinato played by low cellos, double basses and percussion that represents the rapid movement of the massive figure of the Olympian god. This is swiftly answered by a repeating brass sforzando signifying the rapid strikes of the player as she or he is searching for the *Achilles heel* of his intimidating opponent.

Although the tempo of the piece remains consistent, there is heavy use of irregular phrasing to represent the chaos of the developing battle as this is one of the most stressful fights the player will encounter. The piece begins with the repetition of a two bar phrase in 3/4 in the lower strings that is answered in 00:08 by a two bar phrase in 4/4 in the brass. The piece returns to 3/4 string ostinato until 00:28 where the meter changes again to 4/4. After the pause in 00:42, the key modulates from C minor to F minor and the theme that enters consists of a two bar phrase in 4/4 followed by a bar in 4/4 and a bar in 6/4. The final section of the piece (01:07) returns to C minor and 3/4 in order to ensure a seamless loop.

#### **6.5 *Street musicians*<sup>169</sup>**

These three short compositions are the only diegetic uses of music in the game. They are solo instrumental pieces that are performed by different characters in the narrative and their volume and panning are determined by the distance between the player and the performing musician.

---

<sup>168</sup> Audio example 10

<sup>169</sup> Audio examples 12, 13, 14

The idea behind *Street Musician 1 – Welcome to the Agora* was to recreate an allegedly famous song of the time that is performed on the lyre by musicians encountered in the streets of the Agora and the Acropolis. With the help of some creative equalization and reverb processing, the sound of a modern harp was manipulated to resemble the sound of an imaginary ancient lyre. Whenever the player comes near a street musician this music is layered on top of any ambient music that might already be playing for that area. Although the performing musician layer was not pre-planned and is not synced with the ambient track, it usually produces stylistically coherent and interesting recombinations. This is due to the fact that the two compositions that can be combined with this piece are *Trojan Shores* and *Ten Years of War*, both of which include sparse arrangements with slower tempos, long drones, and incorporate the same lyre instrumentation and identical tempos.

*Street Musician 2 – Dance of Dionysus* is used during the *Vineyard of Dionysus* quest in which the player has to quickly locate and drink a number of wine bottles hidden around the area. The music is performed by *Dionysus* himself playing the panpipes while being surrounded by dancing satyrs. The melody is playful and matches the lively festive atmosphere of the quest.

*Street Musician 3 – Apollo's Light* is used only once as the player enters Apollo's palace and finds Apollo playing his lyre. The piece is hypothetically written by Apollo who is known as the god of music, and consists of a memorable melody played by the right hand and a simple two note accompaniment played by the left hand. Apollo performs this piece indefinitely until the player interrupts him by attacking one of his guards.



## 6.6 Defeat/Stalemate/Victory<sup>170</sup>

These three short compositions were primarily created to accompany a special version of the game named *Apotheon Arena* in which players combat against each other in multiplayer matches rather than following the original narrative of the single player campaign. Although these compositions are repeated a considerable amount of times in both multiplayer and campaign modes, they were purposefully created as one shot through-composed pieces. This was done because the goal of this music is not only to establish an appropriate mood, but also to function as a sound symbol that signifies a particular meaning. Karen Collins in her paper *Functions of Game Audio* states that “symbols and leitmotifs are often used to assist the player in identifying other characters, moods, environments and objects, to help the game become more comprehensible and to decrease the learning curve for new players.”<sup>171</sup>

An example of this can be heard in the *Zelda* games where lesser enemies have the same music but bosses are identified not only by their appearance but also because the accompanying music is different and thus identifying a unique enemy.

According to the outcome of these multiplayer battles one of the three tracks would be triggered once as a sound symbol to notify the player of the result: *Defeat*, *Stalemate* or *Victory*. However, with the exception of *Stalemate* these pieces have also been used as sound symbols in the campaign of the main game. The implementation is as follows:

- *Defeat* is played when the player loses a match in multiplayer mode or dies in the campaign.
- *Stalemate* is only used in the rare scenario of a tie in multiplayer mode.

---

<sup>170</sup> Audio examples 19, 20, 21

<sup>171</sup> Collins, Karen, et al., *Essays on Sound and Vision*, 2009, p.271.

- *Victory* is used when the player wins a multiplayer combat or when the player defeats a god or major enemy in the campaign.

*Victory* and *Defeat* are both choir based compositions that reproduce the appropriate mood by using contrasting musical language and lyrics. *Victory* uses a fast tempo of 160 crotchets per minute, a simple two chord harmonic progression and heroic lyrics centred around the names of the legendary mythical warriors Atreus and Achilles. Atreus was a mythological king of Mycenae whose name can be loosely translated as the one who is fearless.<sup>172</sup> The word derives from the Greek negative prefix ἄ- (a-) combined with Greek τρέω (treō) meaning to tremble or flee from fear.<sup>173</sup>

*Defeat* is an important composition as depending on the skills of the player it is likely to be played numerous times in the game. The tempo is 48 minims per minute and it is based on a 5/2 metre. The harmonic progression is highly chromatic with use of diminished 7<sup>th</sup> chords and borrowed minor chords from other keys. Figure 6.5 showcases a sketch of the chord progression. The lyrics are loosely based on the ancient Greek phrase from Homer's Illiad “Ὕπνῳ καὶ θανάτῳ διδυμάουσιν” that can be approximately translated as “Death and Sleep are twin brothers”.<sup>174</sup>

---

<sup>172</sup> My translation

<sup>173</sup> "User-Submitted Name Atreus." *Behind the Name*. N.p., 2013. Web. 9 Aug. 2017. <<https://www.behindthename.com/name/atreus/submitted>>.

<sup>174</sup> My translation

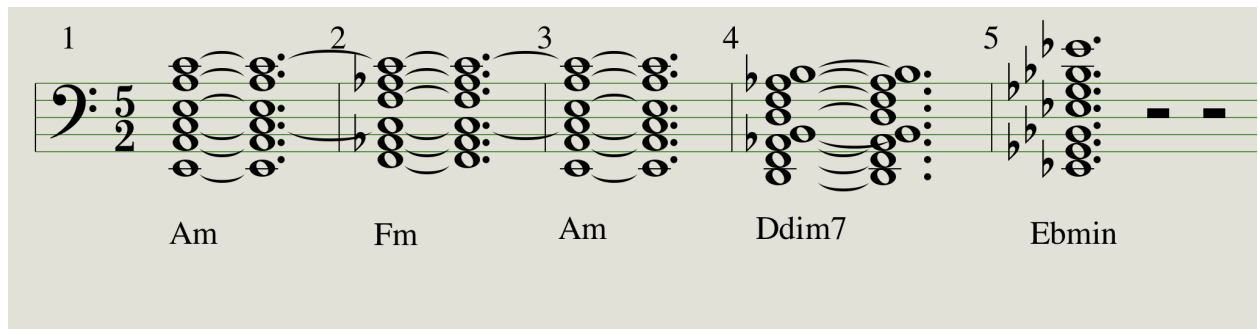

Figure 6.5: *Defeat* chord progression

### 6.7 *Ten Years of War/ Trojan Shores*<sup>175</sup>

These two compositions are the ambient tracks used for the *Agora* and *Acropolis* levels although they also appear briefly in other parts of the game such as in Apollo's palace and in the final return to the Village of Dion at the end of the game. Both tracks were composed at the same time and use similar instrumentation and an identical tempo of 48 beats per minute. The purpose of the music is to evoke an archaic ceremonial mood inspired by the mysterious cults, rituals, and animal sacrifices to the Gods that were common in ancient Greece, as for example in the *Eleusinian Mysteries*.<sup>176</sup> Figure 6.6 demonstrates a statue of a 2<sup>nd</sup>-century Cybele priest with instruments associated with her cult that were used for inspiration: a cymbala (upper left), a tympanum (upper right) and a Phrygian aulos (middle right). The instrumentation of both compositions is based around a similar combination of traditional instruments meant to replicate the sound of equivalent instruments from ancient Greece. The instrumental choices were based on research of historical and geographical information on ancient Greek music as well as my experience of listening to the sonic colour of modern recreations of such instruments. The arrangement is centred around a slow cyclical drum pulse that is supposedly played on the tympanum, an ancient hand drum of approximately 30 cm in diameter. A sampled set of Roman war drums was used to replicated this instrument

<sup>175</sup> Audio examples 09, 18

<sup>176</sup> Moulton, Carroll. *Ancient Greece and Rome: An Encyclopedia for Students Vol. 3*, 1998, pp. 178-180.

from the East West virtual instrument *StormDrum 2*. Judging from the strong low-end presence of their sound, the sampled drums were much bigger but this was a conscious choice taken for dramatic effect. The sound of a heavily processed orchestral harp was used to replicate the lyre, a common ancient small harp usually plucked by fingers. The phorminx, another type of ancient harp similar to the kithara which is played with a plectrum, was simulated by the qanun which is also played with a plectrum and can be found in the region.



Figure 6.6: A 2<sup>nd</sup> Century Cybele priest with the instruments associated with her cult, cymbala (upper left), tympanum (upper right), and Phrygian aulos (middle right).<sup>177</sup>

<sup>177</sup> McKinnon, James W., and Robert Anderson. "Tympanum." *Grove Music Online. Oxford Music Online*. N.p., 2017. Web. 9 Aug. 2017. <<http://0-www.oxfordmusiconline.com.wam.city.ac.uk/subscriber/article/grove/music/28671>>.

The arrangements are embellished by melodic improvisations on two wind instruments that are prominent across the entire *Apotheon* soundtrack, the duduk and the ney. The duduk was used to replicate the sound of the aulos while the ney was used to replicate the sound of a syrinx. Duduk has been frequently used in film music to evoke an archaic setting but also it bears a visual resemblance to images of the aulos depicted in ancient Greek artwork, given that both instruments use a double reed. The ney was chosen due to its cultural and geographical association with Persian and ancient Egyptian music dating as far back as the 3<sup>rd</sup> millennium BCE.<sup>178</sup> Although these two instruments bear no visual resemblance, according to J.W. McKinnon the pipes used in Greek and Roman syrinx were always short and therefore high pitched, suggesting a register that is suitable for the ney.<sup>179</sup>

The ethereal female vocalizations common in both compositions are intended to resemble the voice of the oracle from the earlier stages of the game that is also present in certain cells of *The Village of Dion*. Both compositions were licensed in 2016 for use in 10 episodes of the documentary series *You Are Not Alone* (Greek: *Δεν Είσαι Μόνος*) that focuses on the history of the Eastern Orthodox Church and Byzantium and was produced by the Greek National Television channel *ERT*. The musical inspiration for these pieces came from Knut Avenstroup Huagen's *The Dreaming: Ere the World Crumbles* from his soundtrack to the MMORPG *Conan: Hyborian adventures*.

---

<sup>178</sup> Hassan, Scheherazade Qassim, and Jean During. "Ney [Nai, Nāī, Nāy, Nay]." *Grove Music Online. Oxford Music Online*. Web. 23 Aug. 2017 . <<http://0-www.oxfordmusiconline.com.wam.city.ac.uk/subscriber/article/grove/music/19644>>.

<sup>179</sup> McKinnon, W. James. "Syrinx." *Grove Music Online. Oxford Music Online*. Web. 23 Aug. 2017. <<http://0-www.oxfordmusiconline.com.wam.city.ac.uk/subscriber/article/grove/music/27275>>.

## 6.8 Maze of Athena<sup>180</sup>

The *Athena* level was initially planned as a large level based on a massive labyrinth with complex mechanics and multiple side quests for which a recombinant cells composition would be needed. After having composed some initial recombinant ideas, the developers decided to make substantial changes to the level as it appeared to be too challenging and potentially frustrating to the game testers. Lee Vermeulen informed me that “We will still be having a *Athena* level, but it will be a lot smaller than we imagined. It will be most likely 3-4 minutes of traveling the *Athena* level for items (while it spins). So a simple ambient track for that would work well”.<sup>181</sup> Due to the shortened length of the maze a full recombinant composition was not needed and a linear loop of the initial cells was used instead.

As it can be seen in video example 6.1 the level ended up being a psychedelic experience of a rotating maze of buildings in which the player is spinning around as she or he is trying to find a way out. An important influence to this composition was Bernard Herman’s opening theme of Alfred Hitchcock’s 1958 movie *Vertigo*. Herman’s score features sudden changes in dynamics with ostinato arpeggios moving in contrasting motion with frequent harmonic clashes (see figure 6.7).



Figure 6.7: The opening four bars of Bernard Hermann’s main theme from *Vertigo*.<sup>182</sup>

<sup>180</sup> Audio example 11

<sup>181</sup> email communication with the programmer Lee Vermeulen.

<sup>182</sup> Herrmann, Bernard. *Vertigo Theme*. Hal Leonard, 1958.

In order to recreate an equally disorientating and dizzying atmosphere in *Maze of Athena*, multiple strategies were employed. The piece uses arpeggiated repeating patterns in the marimba that are based around a B minor chord that constantly transpose up and down a minor 2<sup>nd</sup> from B minor to C minor, and more rarely from Eb minor to E minor. The repeating pulse is designed to resemble the turning wheels of the maze's mechanism and is enhanced by light percussion and various scratching and bowing effects on the cymbals and on Tibetan singing bowls. The melodic phrases have an irregular length and starting point and there is frequent use of chromaticism. The qanun is played using tremolo picking and the ney makes use of multiphonics. All the tracks make use of different amounts of reverb with an impulse response taken from a large cathedral found in East West's *Play* sampler.

## Chapter 6 summary

This chapter examined the musical features, inspiration, intentions, relationship to the narrative, and connection to other compositions for each individual through-composed piece in the portfolio. The pieces used in this chapter did not employ recombinant techniques for a number of reasons. Certain compositions appeared in parts of the game that were not likely to be repeated such as boss battles (*March from Hades*, *Achilles Heel*) and therefore were not likely to need extensive looping. Shorter compositions (ex: *defeat*, *victory*) were used as one-shot sound symbols to signify particular meanings where the use of stochastic recombination might have caused these symbols to be misinterpreted. Ambient through-composed pieces *Ten Years of War* and *Trojan Shores* were designed to have the same tempo and instrumentation in order to function interchangeably as well as in combination with the music of the wandering street musician compositions. Ambient track *Athena* was considered to be of trivial importance to the narrative to justify the time commitment needed to develop it into a full recombinant composition. The next chapter will examine the development of and use of recombinant compositions throughout the game.



## CHAPTER 7: RECOMBINANT TECHNIQUES IN *APOTHEON*

### 7.1 Intro & aims of the chapter

In the previous chapters we have seen how stochastic recombinant techniques can be used to successfully reduce repetition in game music. Games such as *Times of Lore* and *Legend of Zelda: Ocarina of Time* implemented recombinant algorithms that used probabilities to generate meaningful variations of pre-constructed thematic material in order to combat repetition and constant linear looping. As noted earlier, in both of these games the recombinations were not connected to the narrative of the game which caused the music to lack a sense of development or direction.

This chapter will explore how stochastic recombinant techniques have been developed further in the videogame *Apotheon* by examining each of the recombinant compositions in the accompanying portfolio. The recombinant cells engine and the other recombinant techniques developed for *Apotheon* are a step forward in stochastic recombinant algorithms as they combine the sequential block distribution proposed by Berndt and the stochastic recombinant model proposed by Raybould-Stevens. The principal improvement from previous games is that by altering the occurrence probabilities and availability of the cells according to gameplay parameters, the structure of the recombinations is generated by the narrative of the game and the actions of the player. A successful recombinant system designed to work in a video game context must not only be able to diminish repetition but it must at the same time, be as adaptive as possible to gameplay changes.

The recombinant cells system and all the recombinant techniques explored in this chapter were developed and implemented as a collaboration between *Alientrap*'s director and lead

programmer Lee Vermeulen, and myself. Vermeulen handled all the coding and implementation responsibilities while I was responsible for the composition of the music as well as the conceptualization and design of each recombinant system. The principal recombinant cells engine for *The Village* area was redesigned three times before the final version was implemented in the game. Sections 7.2 to 7.4 trace those developments in order to highlight how different musical challenges associated with recombinant music were resolved and improved upon.

### **7.2 *The Village*: Creating the first version of the stochastic recombinant engine**

After discussing my idea with the lead programmer Lee Vermeulen, he agreed to assist me in implementing a stochastic recombinant engine but suggested testing it first on the opening level of the game, *The Village*. This decision was made because this level would be an area where players would inevitably spend significant amounts of time and would return to on multiple occasions, therefore making it an ideal locus for experimentation.

When I received the first playable demo of the opening level I decided to write a slow dark atmospheric piece that evokes the mythological character of the game, while building tension and warning the player that something threatening is about to happen. It is important to note that at the time I was not certain about how the engine was going to function, so it was difficult to compose any thematic material in advance. As this was my first attempt at creating a stochastic recombinant system I decided to approach the composition in a linear traditional manner and later break it down to smaller sections of individual cells that would eventually be randomized by the engine.

The instrumentation of the linear piece was:

- Female solo voice (alto) performed on the virtual instrument *Voices of Passion* by Quantum Leap
- 70-piece string orchestra, 4 Trombones in Bb, 6 Horns in F, cymbals, and gongs recreated by using sample libraries from East West's *Symphonic Orchestra* Platinum edition
- a Duduk and an Oud, performed on the virtual instrument *RA* by Quantum Leap
- *Dynasty of Daiko* percussion ensemble performed on the virtual instrument *StormDrum 3* by East West.

In order for the engine to work, I thought that every component needed to be of an equal or proportional size so all the recombinations would stay in sync with each other. I exported everything into Pro Tools 10 and edited all the audio accordingly. As it can be seen in figure 7.1, I divided all the audio files in small music blocks or cells that are made of individual phrases or motifs. After some experimentation I found out that the best average cell length for this composition was four bars, which was 19 seconds of time. Experiments with shorter phrases generated more variation as there was a greater number of cells available to recombine, but made it difficult to create meaningful musical results. To avoid making the music predictable by using only four bar phrases, I also used material that was over four bars and added silence at the end of each phrase until it reached a length of eight bars in order for the cells to be proportional and remain in sync. Every resulting cell had the same tempo and tonality and were edited so each phrase will start on beat one.

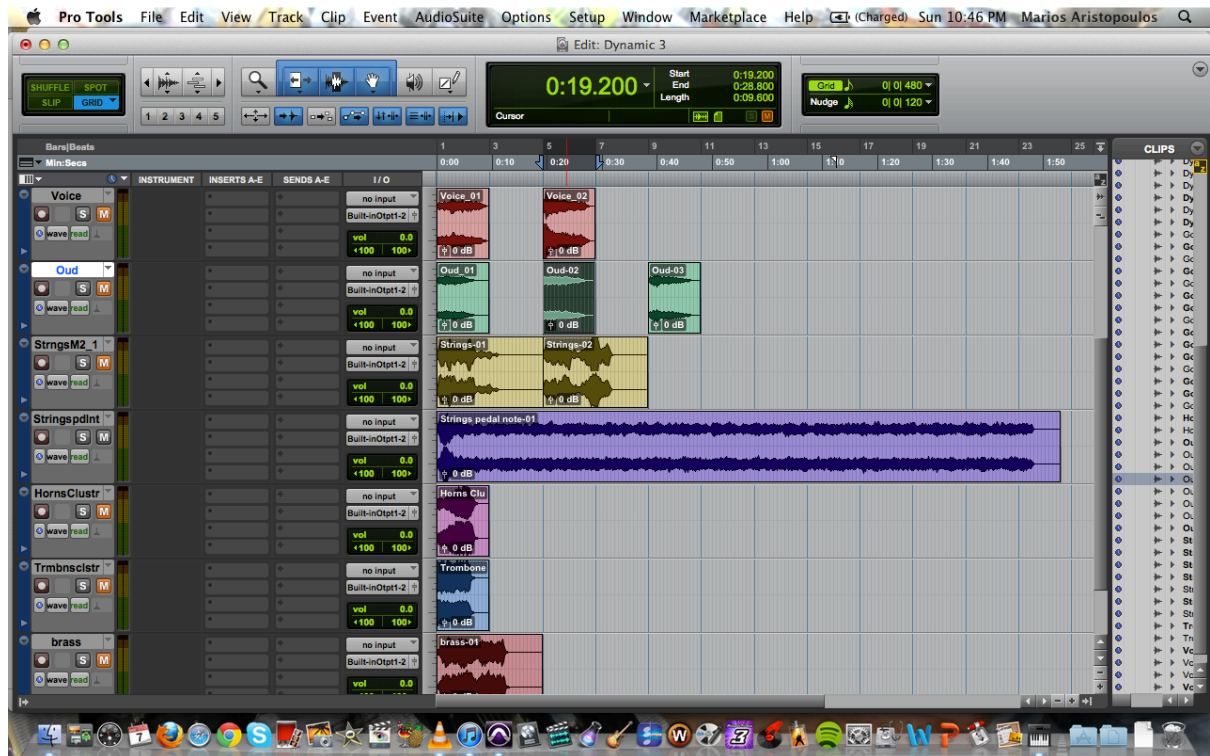

Figure 7.1: Arrangement of the cells by instrument in Pro Tools

Following this, I organized cells into different functional groups, and placed them in horizontal layers (figure 7.2). In this first experiment the material was placed in 5 groups: melody, bass, ambience, percussion and cymbals. Each group contained 5 different variations, based on function, regardless of the instrumentation. For example, in the melodic group I would include the voice, the duduk, and the oud, while in the bass I would include different strings, trombones and horn clusters. The only exception was the ambience group that contained only two variations of different pedal notes that lasted 48 bars (12 times the normal cell value). The reason only a tonic and a dominant pedal were used was to make it easier for any recombinations to be harmonically compatible. Recordings of the individual cells can be found in the supporting materials folder under the name *The Village original cells examples* in example 7.1.



Figure 7.2: Placement of each cell in five different groups/layers according to function rather than instrumentation.

Finally, I exported each file with a name that corresponds to each group: Melody 1, Melody 2, Bass 1, Bass 2 and so forth. The idea was that the system would start with all five layers playing simultaneously while the engine would pick and play a random cell from each layer. When that repetition had finished, the engine would immediately pick and play a different cell at random. As every cell was proportional, it was impossible for cells to fall out of sync and cause rhythmical inconsistencies.

### Evaluation of the first experiment.

After creating the dynamic engine and implementing it into the game, I was pleasantly surprised to find that all the mechanics worked straight away. The four layers of five cells would generate an endless stream of five-part cell sequences (ex: 24315, 52134, 13425 etc.) that would recombine in 625 different ways and extended the linear duration of the piece

from 2:18 to more than three hours of music using the same material, in a similar fashion to Mozart's *K516f* analysed in chapter 2.4.

An extract of the musical results generated by this engine can be heard by listening to example 7.1. After listening to the music for a while it quickly became obvious that the although the engine avoided exact linear repetition, the aesthetical result was rather dull and quickly became predictable. Karen Collins's criticisms of procedural systems frequently sounding like an "aural collage" would certainly be applicable to this example. The problem was also enhanced by some characteristic motifs reoccurring very frequently, while the orchestration was found to be rigid and unimaginative as there was always the same amount of layers playing and each phrase started on the first beat. Finally, there was also the issue of small battles occurring around the level where the music needed to change in order to reflect a major shift in gameplay, a situation to which this engine did not adapt to any degree.

### **7.3 *The Village* version 2: Developing the stochastic recombinant engine further**

Some of the problems were easy to fix with simple solutions, while others proved to be more complicated. A useful solution to the problem of thematic repetition was to use probability percentages for each cell. This way, I was able to achieve more controlled results as I could determine the number of occurrences of each cell. As one can observe in figure 6.8, by adding a certain probability that each cell would be selected from the engine, I was able to use rhythmic cells that gave vitality to the structure more frequently, while avoiding recognizable motifs such as the voice. After some trial and error, I found the percentages that created a musical result that was closer to my aesthetic vision.

The most crucial change to the engine was the simple but effective idea of including silence as a probability. By using silence, the whole orchestration of the piece became more interesting, as it no longer followed a fixed and continuous five-layer structure (see figure 7.3). The cymbals, percussion and ambient layers were more frequent but the melody and bass would be sparser creating a fluid structure that gave the illusion of a progression and development of the composition. Sometimes the structure would consist of one or two layers while in some rare moments it would consist of all four.

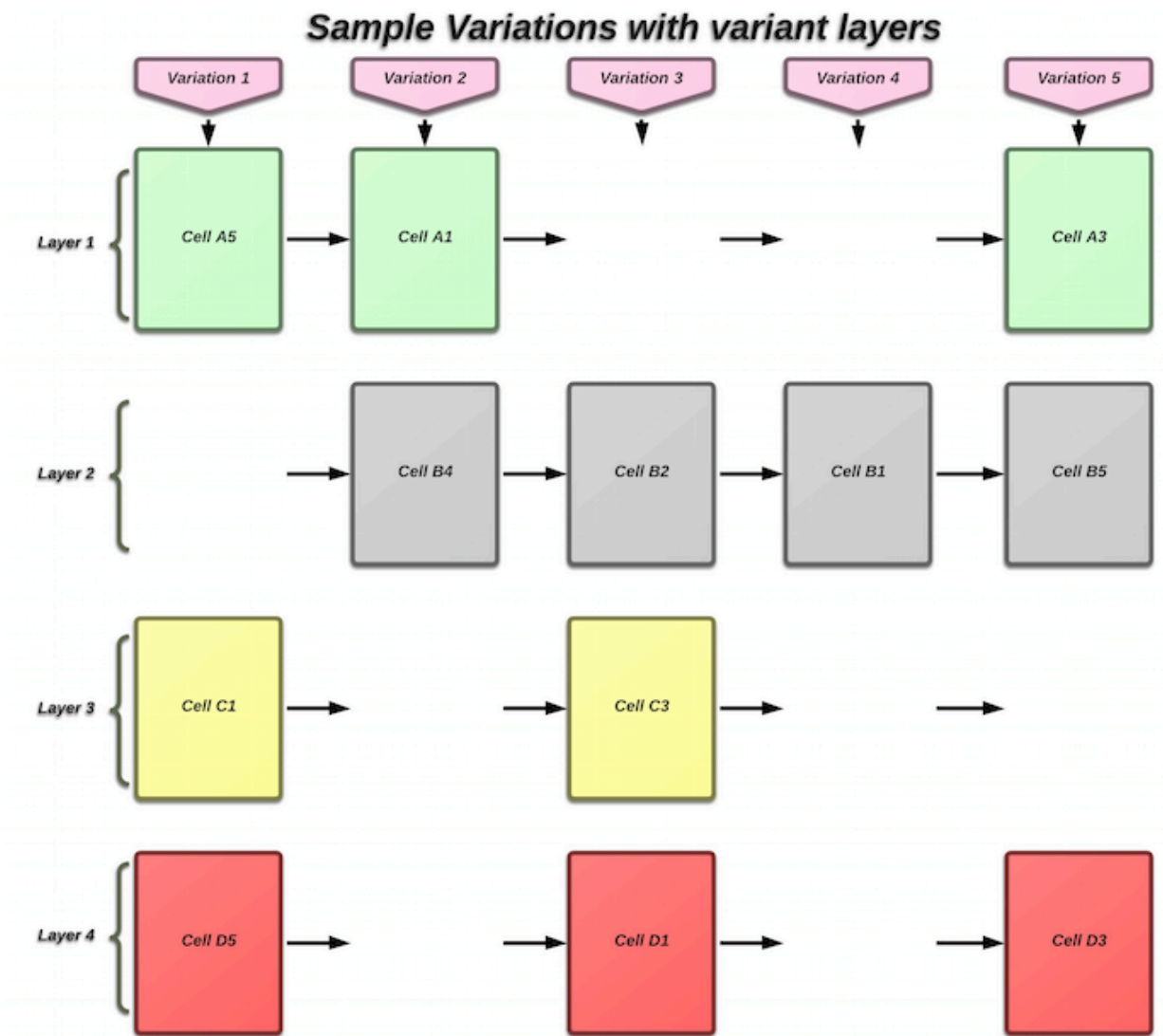

Figure 7.3: By using silence as a cell probability the number of layers is varied in the arrangement.

Another simple improvement that worked quite well in version 2 was to add silence in the beginning of some cells. As mentioned earlier, all the cells initially started on beat 1 for syncing purposes, a fact that made the flow of the music become quickly predictable, with continuous loops that always had a clear beginning and end. A typical example would be the voice cells where a phrase would start on beat 1 bar 1 and then finish somewhere in bar 2, which would then be followed by two bars of silence. By inverting this procedure on some cells, and instead starting with the two bars of silence and then placing the phrase in beat 1 of bar 3, I was able to break this pattern of predictable phrases where everything would always start at the same time. Having certain cells start with a pause gave the structure more rhythmic variety and made it feel less repetitive. I was not able to avoid this problem completely, but this strategy was an improvement that contributed a great deal to the final result nonetheless. This idea was explored further in *The Caves* level (analysed in section 7.5), where all motifs inside the cells started at different points within the bar.

The last major change in version 2 was the addition of three battle layers in order to enable the music engine to become more adaptive and switch to a battle mode to accompany gameplay changes. Because of the different mood of the battle music, the track needed to have a faster tempo and more rhythmical movement than the ambient track. This meant that adding different cells would not work well with the existing layers that were composed in a different musical style. For this reason, I decided to treat the battle layers as a new generative composition entirely so I would not have to be restricted by the tonality, tempo or any other issues of compatibility with the ambient cells, echoing Stevens and Raybould's use of meta controls in their recombinant model.<sup>183</sup>

---

<sup>183</sup> see chapter 4.2



To do so I created three battle layers that included cells from the following groups: Strings (cellos and double basses), Brass (four Trombones), and Percussion (O Daiko Set synth). The tempo was faster (100 bps), and there were again five cells in each group. The strings and percussion layers were continuous while the Brass layer appeared less frequent. This was done for several reasons: a) to create a more interesting structure in the same way as with the ambient tracks, b) to avoid frequent harmonic clashes between the brass and the strings that would be caused due to transpositions to the dominant key in the string section which were used to build tension, and c) because I wanted to use all three layers only when the battle was particularly intense and thus make the score more adaptive to the action.

The last and most difficult step was to try and bridge these two generative form compositions whenever a transition from ambience to battle was necessary. Together with the programmer Lee Vermeulen, we tried different approaches and combinations. The first idea was to crossfade between the two compositions in a similar way to the engine of Stevens and Raybould. However, the feedback I received from the development team was that using a regular crossfade sounded sudden and not any different from a linear transition. As Vermeulen explained “I tried completely silencing all other layers and I didn’t like the effect - it was really sudden and no different than the other levels where it switched to a combat song.”<sup>184</sup>

Transitions between different gameplay modes are a major problem in video game music in general, as it is hard to predict when they are going to happen and how to connect different pieces of music without sounding abrupt.<sup>185</sup> What we found to be the best solution was that

---

<sup>184</sup> Email communication between myself and the lead programmer 20/10/2012

<sup>185</sup> Collins, *Game Sound*, p. 28.

once the battle trigger was enabled, battle layers would be gradually added on top of the music while the ambient layers would be taken out independently using different amounts of fades according to the length of each cell (e.g. the percussion could be replaced immediately while the brass might use a five second crossfade). This worked much better as the two recombinant compositions blended more efficiently in and out of combat, with each layer transitioning independently of each other. Video examples 7.2 and 7.3 show gameplay footage from such transitions.

### Evaluation of the second experiment

The implementation of weighted cell probabilities generated much more distinctive and interesting results than the previous version. In the first version, all the cells had the same possibility to be triggered while in the second the probabilities varied greatly between cells and silence was introduced as a probability (see figure 7.4). As a result, the structure of music was no longer static and the scarce occurrence of different melodic motifs created the illusion of textural development.

#### GENERAL AMBIENCE

ambience-01, ambience-02	50% each	silence 0%
qanun-f1, qanun-f2, qanun-f3, qanun-f4, qanun-f5, duduk-f1, duduk-f2, duduk-f3, duduk-f4, duduk-f5	3% each	silence 85%
Xana ambience-01, Xana ambience-02, Xana ambience-03, Xana ambience-04, Xana ambience-05	4% each	silence 80%
bass-01, bass-02, bass-03, bass-04, bass-05	8% each	silence 60%
cymbals-01, cymbals-02, cymbals-03, cymbals-04, cymbals-05	17% each	silence 15%
percussion-01, percussion-02, percussion-03, percussion-04, percussion-05	20% each	Silence 0%

#### GENERAL BATTLE

ambience-01, ambience-02	50% each	silence 0%
battlestrings-01, battlestrings-02, battlestrings-03, battlestrings-04, battlestrings-05	20% each	silence 0%
battlebrass-01, battlebrass-02, battlebrass-03, battlebrass-04, battlebrass-5	20% each	silence 0%

battlepercussion-01, battlepercussion-02, battlepercussion-03, battlepercussion-04, battlepercussion-05	20% each	silence 0%
Xana Battlef-1, Xana Battlef-2, Xana Battlef-3, Xana Battlef-4 Xana Battlef-5	5% each	silence 75%

Figure 7.4: Cell Occurrence Probabilities in the second engine of *Village of Dion*.

Furthermore, adding the minor small structural device of transitioning between the two generative compositions of ambience and battle, although far from being perfect, is a promising area that offers an improvement over the simple linear crossfades that most game music engines currently use. Rather than simply crossfading between two pieces of music or using a third piece as a transition, this technique keeps compatible cells playing from each side and creates a much more gradual transition which is only possible with a recombinant system, since each element of the structure functions differently. This idea is similar to the meta controls used in Stevens and Raybould's engine; however it operates differently as the system doesn't simply alternate between two recombinant compositions, but it does so gradually between independent layers.

If this version of the engine is compared to the engines of earlier games discussed in Chapter 3, it can be argued that it is a step forward as the weighted possibilities of various cells over multiple layers seem to generate a more flexible structure. However, with the exception of the battle transition, the structure was disconnected from what was happening in the gameplay. If there is no connection to the narrative, then there is no reason to run the algorithm in real time, as the system could simply generate some variations in advance and utilize them in the same way as a linear composition. Perhaps the only advantage of running such an algorithm in real time would be to save memory space, but at the cost of needing more CPU power to execute it.

#### **7.4 *The Village* version 3: The final engine implemented in the game**

When the game was accepted in PAX East, a major video games conference that took place in Boston between March 22-24<sup>th</sup>, 2013, and after receiving feedback from a group of testers, the developers decided to completely redesign the opening level. The new design included a completely different approach in order to give a greater sense of direction to what the player had to do and a new storyline with specific objectives that were included in the introduction. The opening level was completely redesigned and replaced by a different and much larger area called *The Village of Dion*, that included many smaller locations: *The Oracle*, *The Temple*, *The Granary*, *The Hunter's Hut*, *The Trireme*, and the *Tyrant's Hideout*. The player could visit and complete necessary objectives in any order as is common in open world games with the exception of *The Tyrant's Hideout* which would only unlock if all the objectives in the smaller subareas were completed. The game designers thought that the music was still appropriate in its mood but needed to adapt to these new changes as best as possible in order to follow the narrative.

This led to the creation of the 3<sup>rd</sup> and final version of the engine. In order to create a stochastic recombinant score that was highly adaptive to gameplay I went back to the Axel Berndt model of sequential block distribution, in which new material is added or removed from the selection pool available to the recombinant system according to what is happening in the game. My approach was to compose new cells that were unique to the sub-areas and game events of the level but that also worked in combination with and in place of pre-existing cells (see figure 7.5).

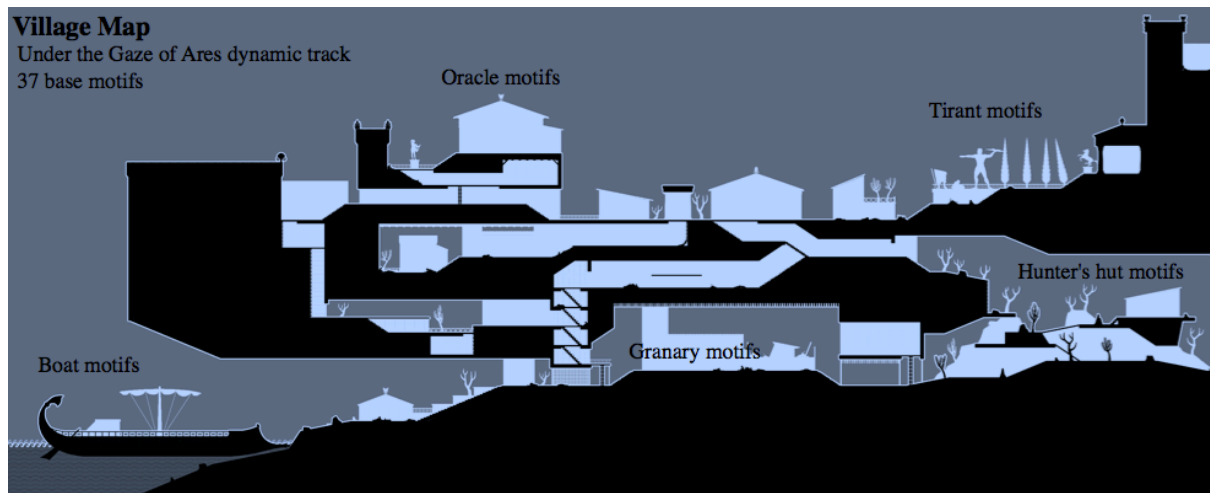

Figure 7.5: 2D map of *The Village* level in version 3 showing the location in which different cells are included in the selection pool.

The engine was modified to use variable occurrence probabilities responding to two main parameters: the game state and the player's location. Each possible player location in the map would trigger a different set of cells to be loaded while certain cells from the previous recombination would remain in the selection pool. The occurrence probabilities of the cells of the first location would gradually start to diminish while the other ones would start to increase. This would result in a more gradual transition in which elements from both locations would coincide as the scenery begins to change. The table in figure 7.6 demonstrates the way that the weighted possibilities were affected by some of the main quests in different sub-areas of *The Village*.

### FIND THE APOTHECARY (ACADEMY) QUEST

ambience-01, ambience-02	50% each	silence 0%
qanun-f1, qanun-f2, qanun-f3, qanun-f4, qanun-f5,	10% each	silence 50%
percussion-01, percussion-02, percussion-03, percussion-04, percussion-05	20% each	Silence 0%
battlestrings-01, battlestrings-02, battlestrings-03, battlestrings-04, battlestrings-05 <b>TRIGGERED when there is battle</b>	<b>TRIGGER</b> 20% each	silence 0%

### FIND THE BLACKSMITH (BLACKSMITH'S HOUSE) QUEST

ambience-01, ambience-02	50% each	silence 0%
anvils-01, anvils-02, anvils-03	33.3% each	silence 0%
battlepercussion-01, battlepercussion-02, battlepercussion-03, battlepercussion-04, battlepercussion-05	20% each	silence 0%
battlebrass-01, battlebrass-02, battlebrass-03, battlebrass-04, battlebrass-5 <b>TRIGGERED when there is battle</b>	<b>TRIGGER</b> 20% each	silence 0%
Timpani-f1 <b>TRIGGERED when there is battle</b>	<b>TRIGGER</b> <b>100%</b>	Silence 0%

Figure 7.6: Occurrence Probabilities tables for some of the quests in “The Village” area. A full table can be found in Appendix D.

For example, when the player approached the ancient boat (*The Trireme*) in the bottom left of the map, a set of melodic cells would replace the main ones, while all the other layers would continue as usual. Likewise, when the battle with the final boss of the level (*The Tyrant*) occurred, a new more powerful and epic layer was added on top of an increasing number of layers to match the appropriate tension of the final battle. In order to implement these changes to the game I created a flow chart to help the programmer connect all the music elements to the game engine (see figure 7.7).

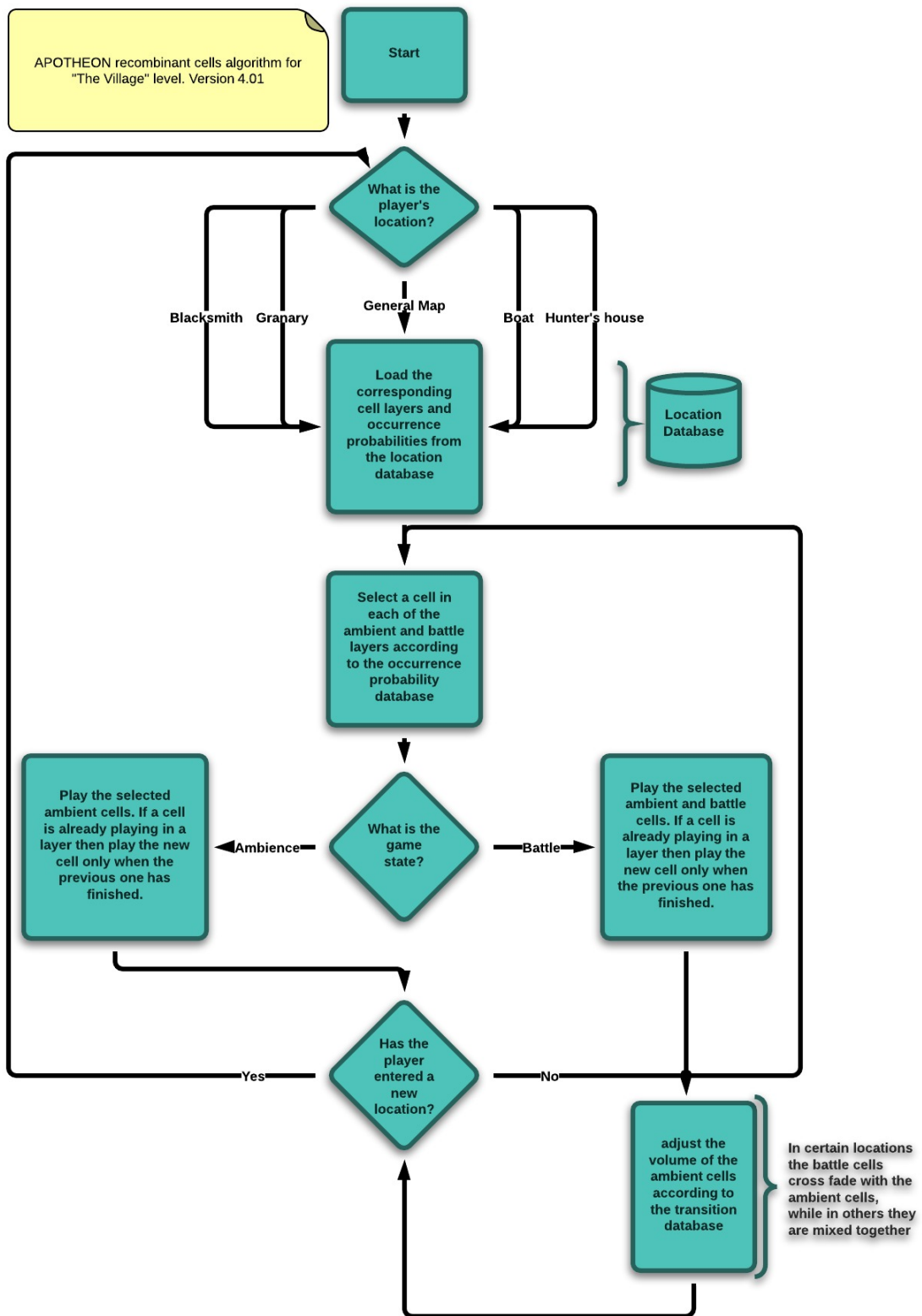

Figure 7.7: Flow Chart for *The Village of Dion* map

The engine also removed cells from the selection pool if they were needed in a particular context by changing its probability to 0%. For example, when the player moved from the main area (*general ambience*) towards *The Granary*, the following changes occurred: The cymbals, percussion, bass and Xana (voice) cells were completely removed from the selection pool, the ambient, qanun and duduk cells remained but their percentages were adjusted from 3% to 10% and two location specific instrumental groups of cells were added, the anvil and the timpani. When the player would return to the main area the engine would re-adjust the selection pool after the end of the cell that is currently playing. In this way, the music for the whole area was treated as one whole composition that consisted of a total of 37 cells including some recording of real vocals.

### **Evaluation of the final engine for *The Village of Dion***

The third version of the stochastic recombinant algorithm was the version that was used in the final version of the game without any further modifications and is the most refined version of the recombinant system implemented in the entire game. A realization of this engine can be experienced by playing the opening level of the game, *The Village of Dion*. Instructions on how to access the game are included in chapter 5.4. In order to assist the reader who might be less eager to combat the Greek Gods an extended video with footage of a walkthrough from the entire level is provided in video example 7.4.<sup>186</sup> The video has a duration of 29 minutes in which the player completes all the objectives that can be found in this area. It should be noted that the player in the video already knew how to navigate through the level and how each objective should be completed. For a new player, this opening level could be much longer in duration.

---

<sup>186</sup> “Apotheon – Gameplay Walkthrough – PS4- Part 1 – Village of Dion - Game Resource H.D.” *YouTube*. N.p., 2015. Web. 12 Dec. 2016. <<https://www.youtube.com/watch?v=MNYiLFupyVs>>.



In comparison to the previous engines as well as the earlier games discussed in the case studies, this final version of the recombinant engine constitutes a significant step forward as it fulfils all of the original purposes it was designed for. The music is recombined in multiple ways in order to truly adapt to the unfolding action and storyline while also adding a significant level of variability with each new play-through, as well as avoiding constant looping during extended gameplay. Feedback from dozens of industry professionals as well as the comments from thousands of players on YouTube and social media included no complaints on account of the quality of the music, or it sounding artificial or computerized due to the use of a recombinant engine. Figure 7.8 in the next page provides a comparative table that summarises the principal differences between the three different engines developed for this level.

It is important to note that if the recombinant engine was not developed and implemented in this level, the original plan from the developers was to loop a linear version of the cells found in the composition *Under the Gaze of Ares*.<sup>187</sup> The linear version of the original cells had a length of 2:18 which would have required the track to be looped 15 times to accompany the gameplay of a quick walkthrough of the entire level, with the number of exact repetitions significantly increasing with more inexperienced players who took longer to complete quests, as well as the experience lacking the adaptive depth offered by the recombinant system. Moreover, the composition of additional original music would have been required if a linear approach had been taken. It would be difficult to produce that amount of original music linearly considering that the game consists of more than ten hours of original gameplay that feature a continuous musical accompaniment. As discussed in earlier chapters this approach

---

<sup>187</sup> Audio example 02 in the accompanying USB.

can be possible in AAA games that can afford large teams of composers such as in the *World of Warcraft* games which included 45 hours of original music.

Engine version	<i>Village of Dion v1</i>	<i>Village of Dion v2</i>	<i>Village of Dion v3</i>
Maximum Number of active Layers	4	7	9
Minimum Number of Active Layer	4	2	2
Maximum Number of available cells per layer	5	6	6
Number of Total Cells available in the selection pool	20	32	57
Key of Cells	D minor	D minor, A minor	D minor, A minor
Use of silence in layers	No	Yes	Yes
Cell length	4 bars	variable	variable
Phrases within a cell begin at	beat 1	Various points	Various points
Cell probabilities	Fixed	Fixed	Adaptive according to progress made in the active quest
Cells available in the selection pool	Fixed	Adaptive according to the game state	Adaptive according to the game state and to the active quest
Adapts to battle	No	Yes	Yes
Battle layers	None	4 fixed	Up to 4 - Adaptive according to the active quest
Transition time between ambience and battle	N/A	4 sec Crossfade	Immediate or 4 sec crossfade according to the active quest
Number of unique possible recombinations	625	279936	60466176

Figure 7.8 Comparative chart of the three recombinant engines developed and tested for the *Village of Dion*.

## 7.5 Recombinant techniques in *The Forest* level



Figure 7.9: A gameplay screenshot from *The Forest* level

*The Forest* is the level in which the player has to go through in his or her search for the goddess Artemis. It consists of multiple smaller areas and is accompanied by three separate compositions based on different recombinant techniques such as layering, parallel composition, and asynchronous cells.

### **In the Forests of Olympus - Vertical Layering**

*In the Forests of Olympus* (audio example 4) is the principal theme of the area and aims to establish a hypnotic atmosphere of wilderness and mysticism. The music is based on a cyclical pattern in 9/8 that alternates between an Am6 and a Gm6 chord. The harp ostinato is occasionally doubled by two steel stringed guitars and embellished with improvised melodic phrases in the duduk and the ney that move between the keys of A minor and G minor. This is the only composition in the game that also makes use of a dilrumba, an Indian string

instrument usually found in Hindustani classical music.<sup>188</sup> Although the dilrumba has no historical or cultural connection to ancient Greece it was chosen for its unique sonic color, enhancing the otherworldliness of the scene.

As the player wanders within the forest she or he will frequently encounter potentially hostile wild animals and mythological creatures. After conducting a few playtests, I decided not to implement a transition to a new battle track to accompany such events as I found it disrupting to the atmosphere created by the ambient track. Instead, I added a percussive layer of djembe improvisations that runs in sync with the ambience and fades in whenever a small battle occurs. Both ambience and battle layers are played as a seamless loop which as it can be seen from the level's flowchart in figure 7.10, is only interrupted in the following three occasions that trigger three individual compositions:

- 1) If the player dies – play the *Defeat* track as a one-shot.
- 2) If the player locates the goddess Artemis – play the recombinant composition *The Deer*.
- 3) If the player enters an underwater cave – play the recombinant composition *Underwater Caves*.

---

<sup>188</sup> Performed on the virtual instrument *Silk* from East West/Quantum Leap Libraries.

## THE FOREST OVERALL LEVEL FLOWCHART

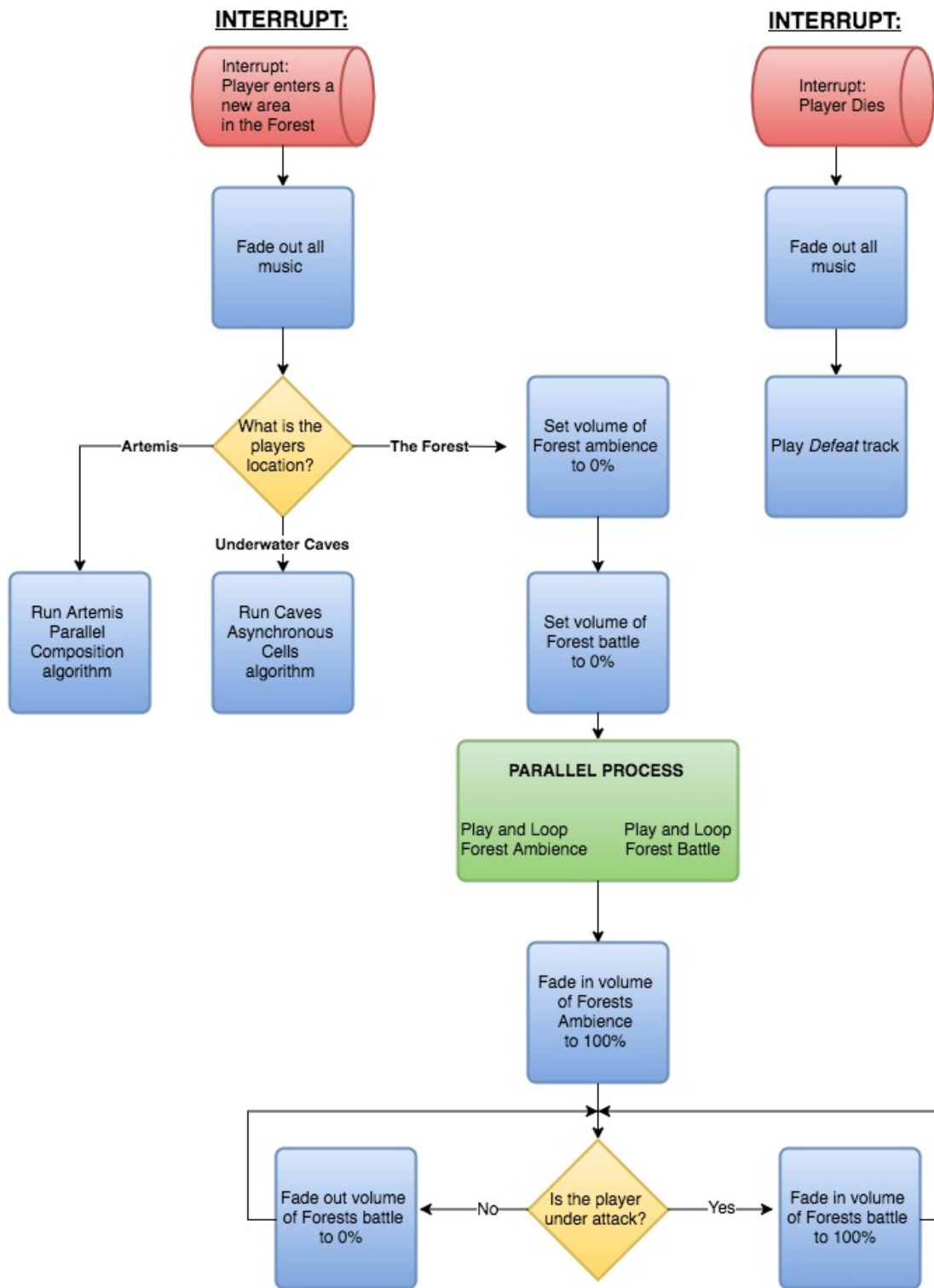

Figure 7.10: Flow chart of *The Forest* level

### **The battle with Artemis – Parallel Composition**

As the player wanders deeper into the forest he or she will eventually encounter the goddess Artemis who will transform *Nikandreos* into a deer and start hunting him down with her bow and arrows. When the player manages to reach certain magical shrines scattered around the area then the roles are reversed as he is transformed into the hunter and the goddess Artemis into a deer. This was an interesting compositional challenge as the timing of the transformation are completely indeterminate and depend on the actions of the player and the development of the action. To solve this problem, I composed two sets of cells, one for the hunter and one for the prey using different instrumentation but similar harmonic structure and tempo. As it can be seen from figure 7.11, during the fight both sets are being simultaneously recombined but only one of them can be heard at a time. Whenever a transformation would occur, the volume of the opposing set will increase while the other one would continue to run silently in the background. This way the transition between them is seamless and there is no gap in the flow of the music. A demonstration of this technique can be seen in the footage of video example 7.5 that demonstrates a quick version of the battle with Artemis.

# BATTLE WITH ARTEMIS PARALLEL COMPOSITION FLOWCHART

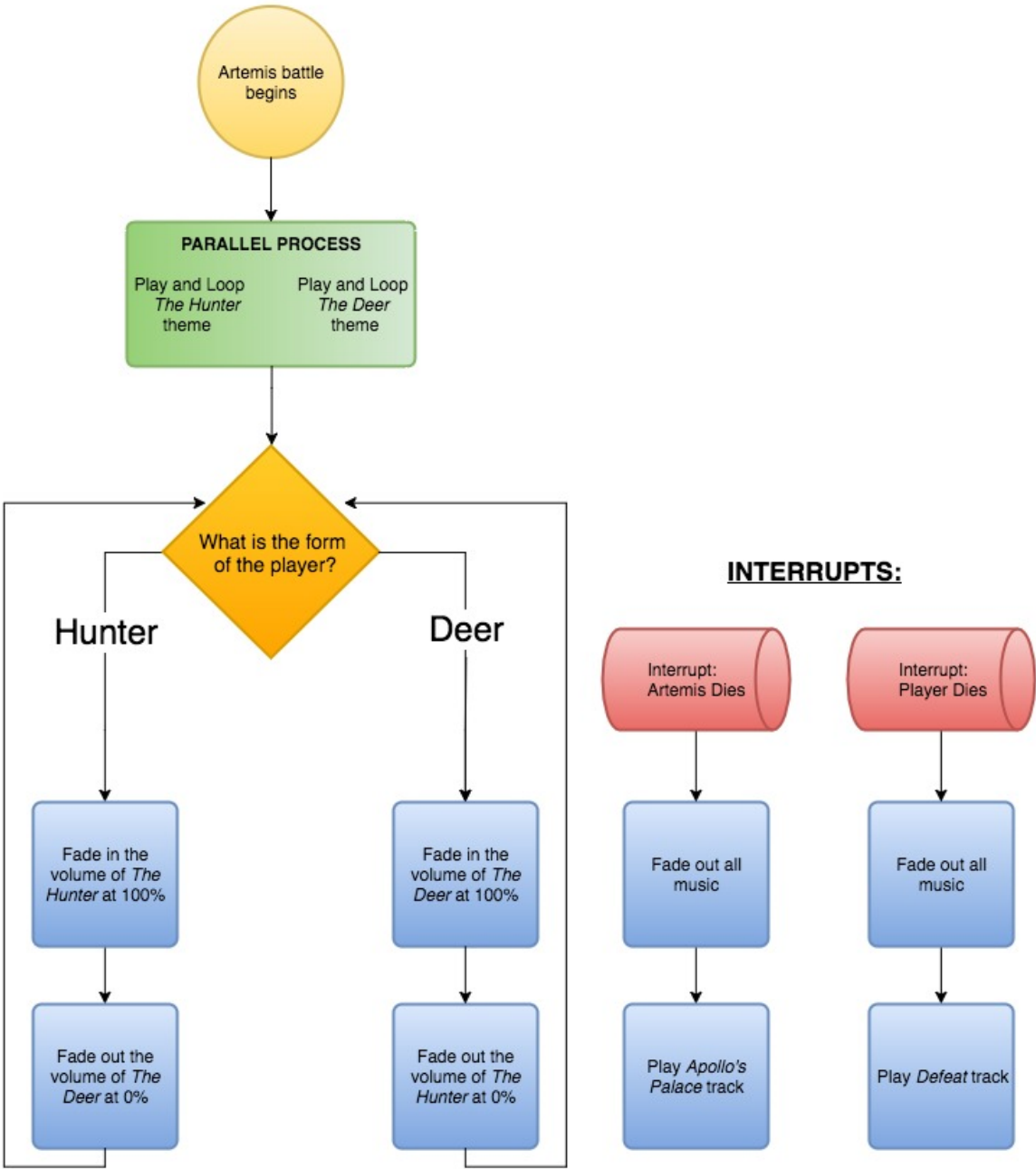

Figure 7.11: Battle with Artemis flowchart

### ***The Caves* level: asynchronous recombinant cells**

*The Caves* is a specific subarea of the game that is located under *The Forest* level which is intended to be “much darker than other levels, with random encounters with spiders, cave dwellers and traps.”<sup>189</sup> The player carries a torch in one hand and visibility is greatly reduced allowing the player to only see clearly around the light of the flame (see figure 7.12).

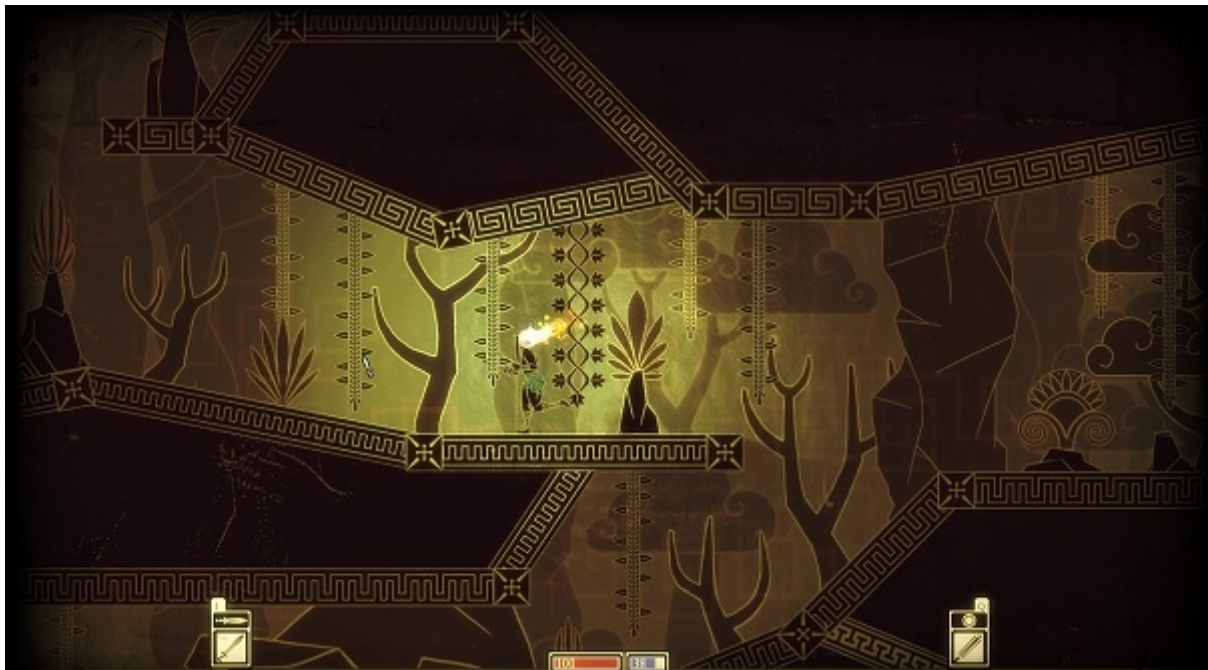

Figure 7.12: *The Caves* gameplay screenshot.

For this level I have used the same recombinant cells technique I developed in *the Village* area, but I tried to incorporate some new features to make the engine adapt faster to the developing action as well as generate recombinations appropriate to the musical language of the composition. The music itself is dissonant and in free tempo using only a string ensemble and some percussion.<sup>190</sup> The musical language is what you would expect from a suspense or horror film incorporating a lot of note clusters, high pedal notes and some extended

---

<sup>189</sup> Email communication between myself and the lead programmer 15/12/2012

<sup>190</sup> All orchestral instruments were based on East West's *Symphonic Orchestra Platinum Series*.



techniques such as sul ponticello tremolo and Bartók pizzicato, mixed with long reverb and delay effects. The average cell length was 23.3 seconds each in order to fit the tempo and phrasing of this composition. The cells were grouped in layers according to instrumentation: Violins (five cells), Violas (five cells), Double Basses (two cells), Gongs (five cells), and Battle Percussion (five cells). The frequency of each group as well as the main structure of the algorithm can be observed in figure 7.13.

The cell percentages gave the music a different texture to *The Village of Dion*, because there are fewer layers used simultaneously and there is a possibility that there will be complete silence in all layers in order to make it even more suspenseful. The most important difference to any other version of the engine is that when the battle occurred the percussion battle cells would be faded in instantly regardless of the timing of the music, to perfectly sync them to the sudden appearance of enemies approaching. This was different to other systems where the music would switch and transition between ambient and battle tracks as the same track continued but extra cells were added on top of the current instrumentation. In order to sync the new cells together, the percussion layer was not triggered when enemies approached, but it was rather played along with the other layers with its volume turned to zero. When an enemy suddenly appeared from the darkness then the volume of the layer would quickly go up in the mix according to the enemy's distance from the player. The percussion layer does not only function as a vertical recombination as it is also recombined horizontally generating different percussion patterns that create an unexpected surprise effect that is perfectly timed to the action. This can be observed in the gameplay footage in video example 7.6 and especially near the ending of the clip (0:50") where the player battles a wild wolf jumping from below.

# THE CAVES - ASYNCHRONOUS CELLS FLOWCHART

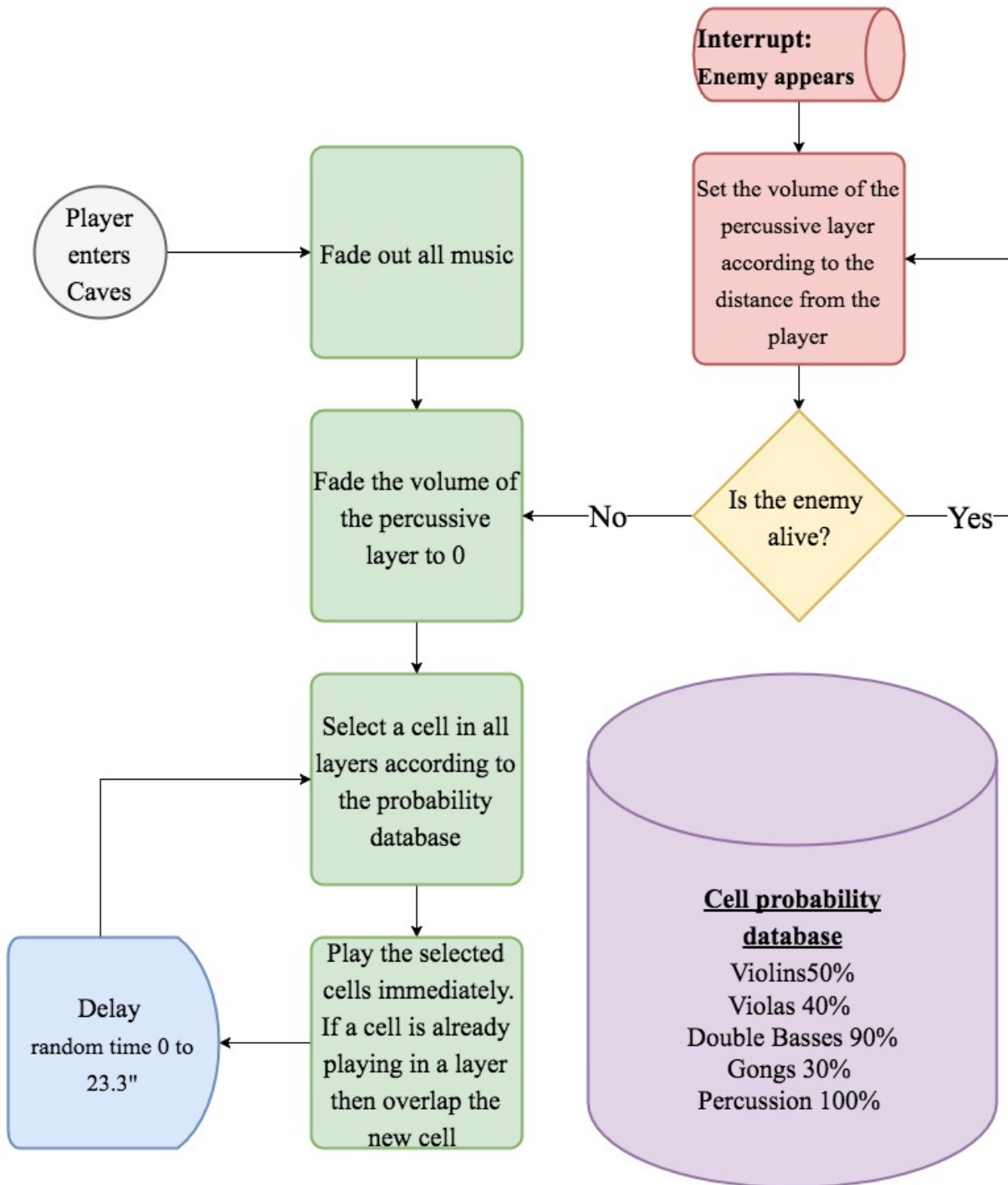

Figure 7.13: *The Caves* asynchronous cells flowchart.

The use of such a technique is not a novelty by itself as many games in the past also use musical stingers to sync up changes in the action. However, the stochastic recombinant system of *Apotheon* makes this work more efficiently. In most games that use stingers, the battle track quickly becomes repetitive and predictable to the player as they have experienced it many times before and the surprise effect has been eliminated. However, in *The Caves* engine the battle layer does not always play the same music and therefore prolongs the element of surprise for a considerable amount of time. Another interesting feature of this version of the engine is that contrary to the algorithm of *The Village of Dion*, the triggered timing of cells is not identical, as each layer can be triggered at different times due to the delay built in on the system. In *Village of Dion*, if a cell was triggered earlier, then the system would wait until it is finished playing before moving to the next. In *The Caves*, if a cell is triggered earlier then it overlaps on top of the current instrument. This works very effectively here because the music is based on instrumental colours and extended techniques and asynchronous cells generate a more varied texture and an unpredictable rhythmical result. However, such an approach could not have been applied in the *Village of Dion* level as the music was indented to have a clear rhythmical pulse and a less dissonant harmony that cannot be achieved with asynchronous cells.

### **7.6 Recombinant Cells in the *Hades Underworld* level**

Hades is one of the main levels of the game in which the player needs to overcome a series of quests across the four mythical rivers of *Lethe*, *Acheron*, *Cocytus* and *Phlegedon* before being rewarded with the godly power of spring and growth by the queen of the underworld, *Persephone*. The description I was given by the lead artist Jesse McGibney was that the

music needed to be “gloomy, dark, cold, sleepy and obviously deathly” to reflect the aesthetic of the visuals (see figure 7.14).<sup>191</sup>



Figure 7.14: Gameplay screenshot from the *Hades Underworld* level.

I was also told that this level would differ from the rest of the game as the underworld is densely populated with reanimated spirits and skeletons wandering in the mist, which require the player to flee rather than stand and fight. To approach this brief, I decided to create one large pool of cells that fit the chthonic character of the level and then experimented with the relationship between the musical structure and the individual gameplay events that occurred in each quest. The result was four individual recombinant systems that triggered according to the location of the player and can be seen in the flowchart of figure 7.15.

---

<sup>191</sup> Email communication with Jesse McGibney.

# HADES UNDERWORLD FLOWCHART

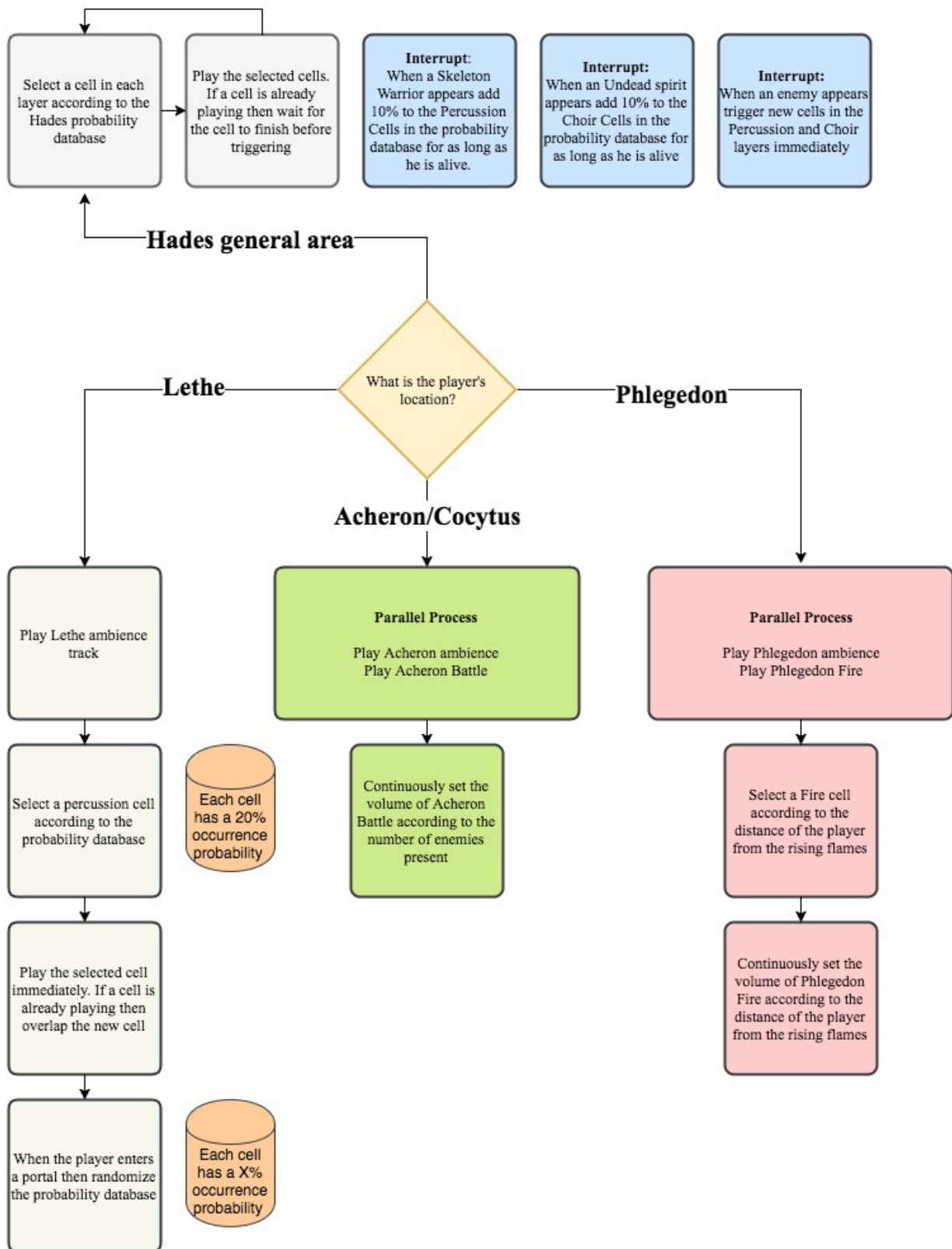

Figure 7.15: Flowchart of the general *Hades Underworld* level.

## **Hades general area**

The cells for this composition were created not only according to their music function (melody, bass, pedal notes, etc.) but also according to specific types of enemies that randomly appeared in the level. For example, a variety of percussion cells using Thai gongs, Tibetan bowls, giant Buddha bells, and sleigh bells were created with the intention of being gradually added to the selection pool of the system as skeleton warriors would appear. In addition, undead spirits would be accompanied by an increasing number of cells based on incomprehensible gibberish whispers. It is interesting to note that the skeleton warriors were programmed to come back to life repeatedly even after the player had eliminated them causing escalating battles and a number of frustrated player comments over internet forums complaining that this level is too difficult.<sup>192</sup>

As can be seen in the flowchart, the initial idea was that each time a specific type of enemy would appear then the probabilities of the corresponding cells would increase by 10% and they would be triggered immediately. This was designed to accompany the escalating tension of reanimated enemies with a growing dissonant texture in the music that would only temporarily stop when the player escaped the battle. However, after playtesting the general area the experience ended up being shorter than anticipated and the main gameplay focus was placed on the mythical rivers instead. It was thus decided that due to the time investment required to successfully implement a stochastic system, a linear representation of this piece would be used instead (audio example 22) with only the individual quests being recombinant/dynamic. This could have been an interesting but challenging composition to

---

<sup>192</sup> "Hades \*SPOILERS\*: Apotheon General Discussions." *Steamcommunity.com*. N.p., 2015. Web. 9 Aug. 2017. <<https://steamcommunity.com/app/208750/discussions/0/606068060828125152/>>

recombine stochastically as the music had a much richer instrumentation and consisted of many more cells than *The Village*, lasting 6 minutes long in a linear arrangement. Figure 7.16 below demonstrates a screenshot of the midi data of all the cells of the general area arranged in Logic pro.

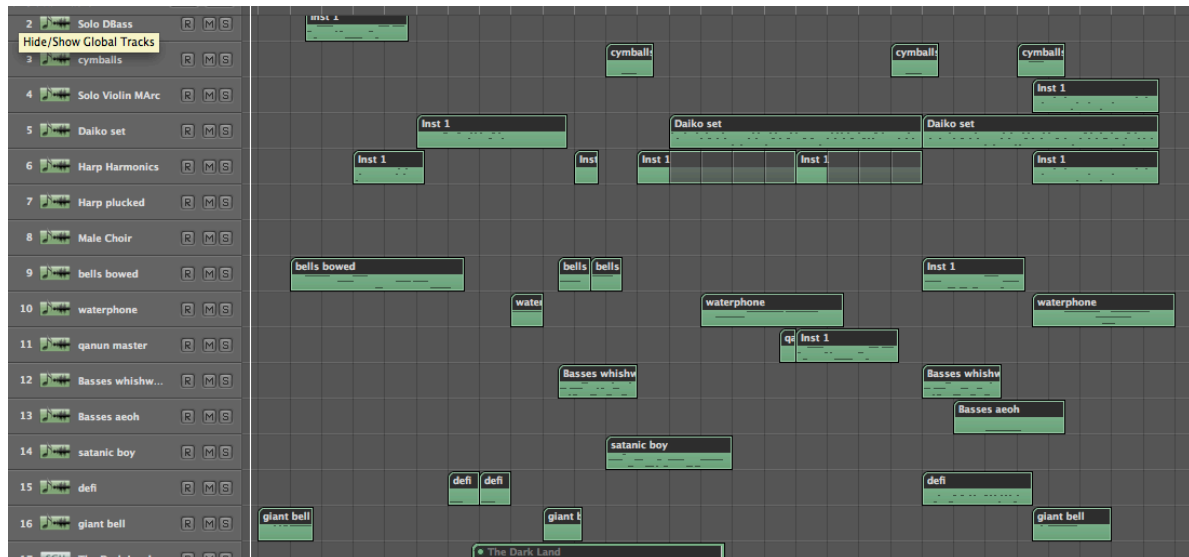

Figure 7.16: Midi files of the *Hades Underworld* music engine.

Gameplay footage of a partial walkthrough of this area can be seen in video example 7.7.

## Lethe

For this special puzzle event in the game, the asynchronous cells idea that was developed in *The Caves* was also implemented, as the music lacked a steady rhythmical pulse. The ambient nature of this composition reflects the complete lack of action of the quest as the player needs to find his or her way across the labyrinth of the river Lethe. The entire composition is based entirely on pedal notes embellished by random recombinations of cells recorded using a sampled waterphone. The unique sound colour of the waterphone was employed in order to mirror the myth of Lethe, whose waters caused forgetfulness.

As it can be seen from the flowchart in figure 6.24 the occurrence percentage of each waterphone cell is randomized every time the player enters one of the doorways leading him or her to an unknown location. The timing of each cell is also randomized leading to a constantly changing structure. The purpose of these randomizations is to add to the confusion of the player by not providing any aural assistance on the puzzle's progress. Video example 7.8 shows a partial walkthrough of this system.

### **Phlegedon**

During this timed event, the player has to fight his or her way up while avoiding being consumed by the flames that rise from the river Phlegedon (river of fire). In this composition, cells based on scratched and bowed cymbal variations are randomly recombined while their overall volume is dependent on the distance of the player to the rising flames. The initial plan was to also modify the occurrence probabilities of the cells as the *Phlegedon* rises, but for an easier implementation only the volume of the fire layer was varied. Video example 7.9 demonstrates a partial walkthrough of this quest.

### **Acheron/Cocytus**

As opposed to the ambient nature of Lethe, these two quests consist of a constant battle that takes place as the player crosses the rivers on a boat. The system used here is simple: an ambient layer based on cells from the Hades general area is combined with a dynamic battle layer that is dependent on the number of enemies present. The battle layer consists of heavy percussion cells created by recorded improvisations on the Lord of the Toms patch of Stormdrum 3. Video example 7.10 demonstrates a partial walkthrough of this quest.



## 7.7 Horizontal resequencing in battle music

### **For Helen Part I, II, III**

*For Helen* is a three-part extended composition based on a variation of the horizontal resequencing technique that accompanies all the battles that occur in the *Agora* and *Acropolis* levels. The purpose of this technique is to provide enough musical variation to accompany the frequent battles that are a major part of the gameplay within these levels. It was designed after taking into consideration negative feedback from playtesting sessions which reported that this music felt repetitive. The problem arose due to the frequency of battles that occur in these levels, usually lasting a very short time. This caused the beginning of the compositions to be repeated constantly while the remaining 15 minutes of original material was rarely heard. To solve this problem each part was broken down to smaller horizontal subsections according to their thematic material.

As can be seen from the flowchart of this track in figure 7.17, when the battle music is triggered the system has an equal chance of 33.3% to select one of the three main parts. After a part is selected then the system selects one of the corresponding sections. Part I and part II are split into four individual sections with a 25% chance of being selected and part III is split into three sections with a 33.3% occurrence probability. After a section has finished playing then the following section will play immediately until all the sections within the part have been played. At the end of the last part the system resets and repeats the process indefinitely unless interrupted by a trigger to crossfade back into the ambient music of the level.

# FOR HELEN - FLOWCHART

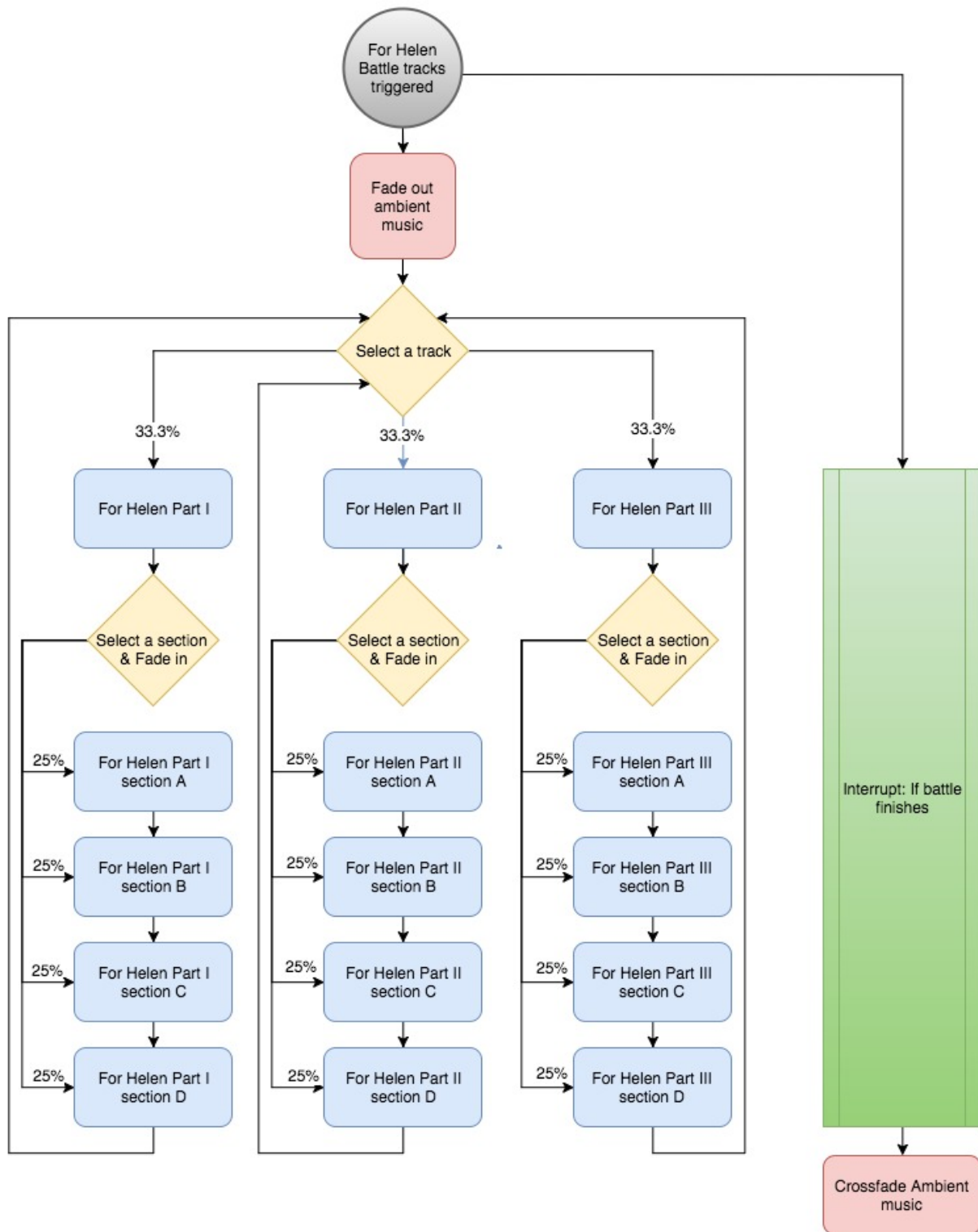

Figure 7.17: Flowchart of the *For Helen* battle compositions

This recombinant system offers alternative starting points for each part but the development of the thematic material itself is always linear. The decision to not allow random recombinations within each part was made due to the musical language and harmonic direction employed in these compositions. As it can be heard from the linear mix of each individual part in audio examples 14, 15, and 16 in the accompanying soundtrack, these compositions are based on ascending transpositions which make use of different metre and are carefully planned in order to increase the tension of the developing battle. By allowing every possible recombination the arrangement would not have been as effective in this particular context.

### **Ares – God of War**

The music composed to accompany the battle within the fighting pits of the *Ares* level makes use of an identical system of multiple starting points, with the only difference that all recombinations are possible. This was more effective in this context as the entire composition remains fixed on a cyclical pattern of six bars consisting of irregular accents on a 4/4 meter, a tempo of 150 beats per minute and free use of chromaticism around the G harmonic minor scale. A linear version of this piece can be heard in audio example 24 which was split in six parts that recombine horizontally.

This composition lacks the heroic character of the other battle tracks in the soundtrack and focuses more on darker and more aggressive themes surrounding the god of war. The instrumentation of this composition makes heavy use of percussion with three simultaneous patches from Stormdrum 3: *Poison Darts*, *Beast Feast*, and *Undiscovered enemy* as well as a variety of cymbals, anvils, and steel plates that accent irregular beats. The accompaniment is based on motifs around minor seconds and diminished fifth intervals played marcato in the

cellos and brass. The brass section consists of two groups of six French horn players that use the lowest possible range of their instruments (down to C1) resulting in a darker tone.<sup>193</sup>

## 7.8 Recombinant compositions that were implemented linearly

### Atlantis

This extended composition is linearly looped over all the major areas and quests of *The Sea* level: *The Tower*, *The Quake*, *The main hub*, *The islands*, and *Isle of Horses*. The player has to sail between these quests using a compass and a naval map and each subarea is separated by the open sea (figure 7.18).



Figure 7.18: *The Sea* naval map used to travel between individual subareas in the level.

The original intent was to create a recombinant cells model identical to the last version of *The Village of Dion* (flowchart in figure 7.7). The basis for the entire level would be a cell set of general ambience, while new sets of individually composed cells for each quest would be

<sup>193</sup> Samples based on *Symphonic Brass Platinum* virtual instrument by East West.

added or removed to the selection pool accordingly. The track *Atlantis* that can be heard in the soundtrack album audio example 23 is a linear mix of all the cells composed for the general ambience set. The cells composed for this track are particularly ambient in nature and were inspired by the calming atmosphere of Greek nautical artwork, the vastness of the open sea and the mysticism surrounding the mythological island of Plato's Atlantis. The harmony is based on repetitions of C minor and G minor chords that are accompanied by a continuous dominant pedal note in G. In the linear mix of the track a chord of Adim7 briefly appears (05:02) in the female choir and was intended to be used sparingly in the recombinant algorithm. The melodic movement is very subtle and is centered around arpeggios of the aforementioned chords with occasional chromatic use and unresolved phrase endings.

The instrumentation of this piece is slightly unusual compared to the rest of the soundtrack. It is the only composition that makes use of a full female choir and an ethereal female voice in reference to the enchanting call of the mythological *Sirens*. The female choir is contrasted by a bass choir which was intended to represent the voices of drowned sailors that have succumbed to the siren song. There is also a subtle use of a muted French horn that reminds the player of his quest and considerable use of multiple overlapping percussion layers using instruments such as qantahar dumbek from Afghanistan and a collection of bells from the virtual instrument *StormDrum 3*. There is also frequent use of berimbau samples, a musical bow of African origin typically found in Brazilian *capoeira*, that might appear as strange choice for an ancient Greek context.<sup>194</sup> I however found that the unique sound produced by the wire string and gourd resonator was fitting in evoking a mysterious and exotic atmosphere and was also reminiscent of the sound that boat ropes create when stretched.

---

<sup>194</sup> Schechter, John, M. "Berimbau." *Grove Music Online. Oxford Music Online*. Web. 9 Aug. 2017. <<http://0-www.oxfordmusiconline.com.wam.city.ac.uk/subscriber/article/grove/music/02811>>.

Unfortunately, the extensive time requirements of the previous recombinant experiments did not encourage the programmer to implement this proposal. This was one of the last compositions to be implemented to the game and due to multiple approaching deadlines and budget limitations it was decided to simply use a linear loop to cover the entire level. This is the only moment in the game that the same music is used to cover multiple locations and remains fixed regardless of what is happening in the gameplay. As can be seen in video example 7.11, this creates a strange effect as the ambient character of the music frequently contrasts the action packed gameplay of major events in the level, such as in the fast paced horse battle with *Hipparchos*. If this recombinant composition had been fully realized, then active battle cells would have been introduced as the battle developed. However, taking into consideration the mystical nature of this location it can be argued that such a contrast creates an otherworldly experience that might be considered fitting. In order to avoid some of the problems associated with constant linear loops discussed in the first chapter, I chose to use silence whenever the player travels between each subarea. The only sound heard in these moments is the ambience of the open sea. It is worth noting that, much to my surprise, the feedback received from six independent gamers playtesting this area prior to the game's release was remarkably positive.

## Road to Troy



Figure 7.19 The main menu of the game in which a sequence of the Olympian gods are passing from the screen.

*Road to Troy* is the music that accompanies the main menu of the game in which the camera pans across a painting of *Nikandreos* facing the 12 Olympian gods (see figure 7.19). This is an important part of the soundtrack, as it is the music that the player listens to each time she or he starts, pauses, or closes the game. The piece is written in the key of G# minor which does not appear again in the rest of the soundtrack and contrasts with *The Village of Dion* piece, that is played in the first area and is written a diminished fifth higher (D minor).

Furthermore, the principal ambient pieces of the game *Trojan Shores* and *Ten Years of War* are written a minor sixth higher (E minor) than the menu music and all three compositions use an identical tempo of 48 beats per minute in order to make transitions as smooth as possible.

The composition is based on improvised arpeggio patterns of a series of extended chords using a 6/8 metre. It was performed on a Manuel Rodriguez flamenco nylon stringed guitar using an Eb drop-down tuning. The sound was then heavily processed with a synced delay

effect to evoke an archaic atmosphere and create a richer texture, particularly over the frequent pauses at the end of each phrase. The excessive use of synced delay was inspired by Matt Uelmen's theme of *Tristram Village* from Blizzard's *Diablo I*.

The structure of the piece was created with the intention of being horizontally recombinant according to the following flow chart (see figure 7.20). Each section is based on small sequences of improvised finger plucking of extended chords that are connected with subtle harmonic movements between each voice. Each section is assigned a different probability according to its importance. The composition always begins with section 1 that is based on a G#min9 chord before being resolved to either a Edim9 or a Bmin9 chord in section 2. Section 3 consists of a repeating phrase moving between G#min9 to E9b5 to Emaj7/b5. Section 4 is a short transitional sequence based on a C#min9 chord in which the fifth moves chromatically down to a C#dim9. When all the sections have been played once then the ending of the composition is triggered based on a short sequence of G#min9 moving to Edim9 and closing with an unresolved chord of Bmin9. Each chord within the sequence can be repeated an indeterminate amount of times according to their occurrence probabilities (labelled with the parameter X) before moving to the next chord in the sequence. This parameter ensures that the harmonic direction of each section is maintained but the length of each chord is irregular as certain chords are more likely to be repeated than others.



# ROAD TO TROY - FLOWCHART

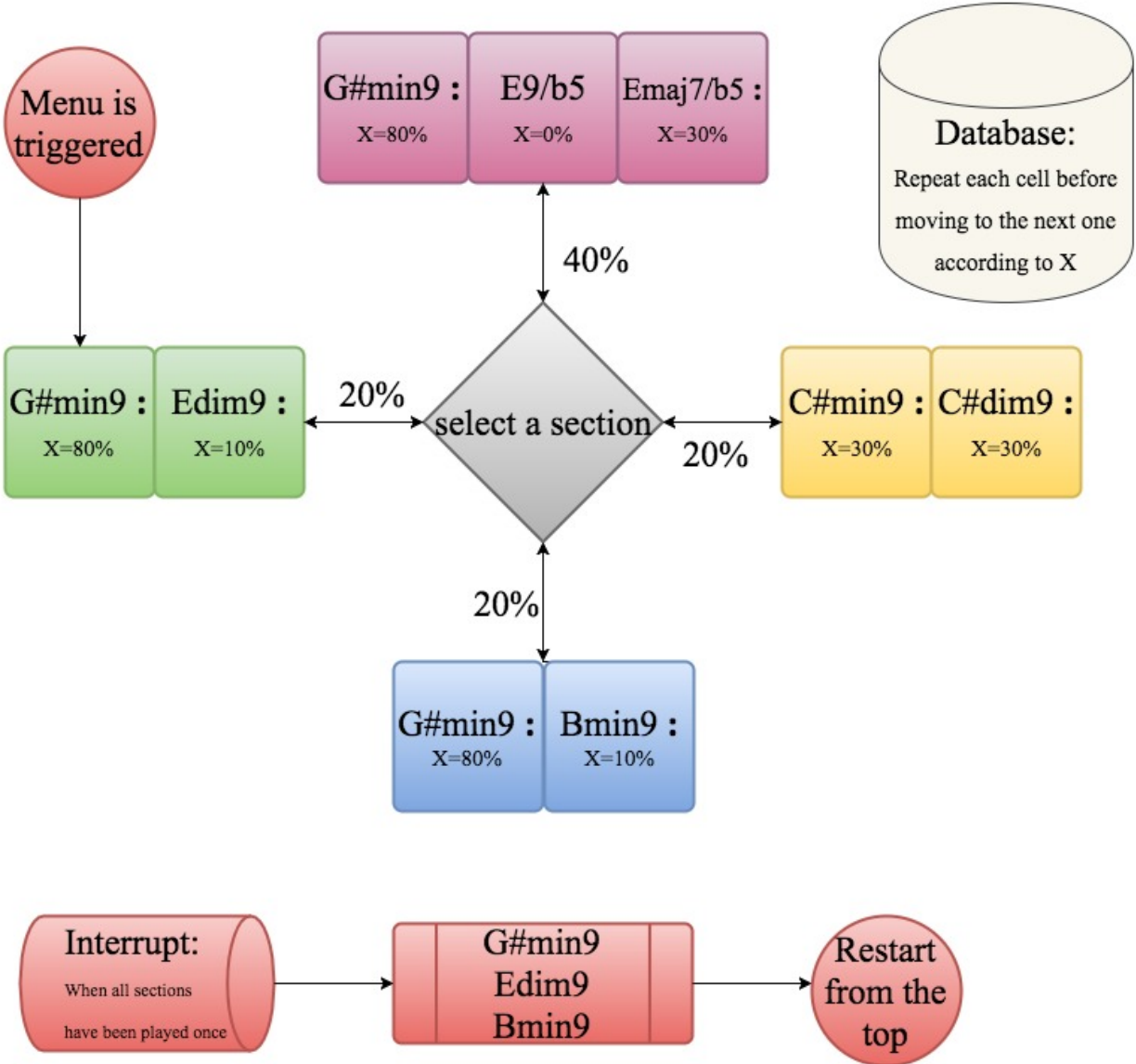

Figure 7.20: Flowchart of the *Road to Troy* menu music

Although this piece was designed to function recombinantly, the music was ultimately implemented by using a linear loop of the original recording. This was partly due to the following challenge: in order to create smooth and interesting transitions, the chords in the guitar recording were embellished with a number of performance techniques such as hammer-ons, pull-offs, and glissandi as well as frequent use of passing notes and inversions. However, when the cells were separated from each other and recombined randomly, the outcome was not aesthetically coherent as the performance lacked the natural phrasing of the original recording. This problem was not encountered in the previous compositions as the recombinations were either occurring in multiple layers or used simpler harmonic progression and thus were easier to connect. This problem can potentially be solved if multiple versions are recorded for each possible chord connection but this would also require a musically aware system that can detect the harmony of the following cell and select an appropriate transition. Due to this complication but also because the animated sequence of the Olympian gods in the menu screen is itself looped linearly, a recombinant track was deemed unnecessary by the developers and a looped recording was chosen instead.

## Chapter 7 Summary

This extended chapter followed closely the development, implementation and experience of the recombinant stochastic techniques used in the open world videogame *Apotheon*. The main achievement here was to advance the earlier recombinant systems used in *Times of Lore* and *Legend of Zelda* following the theoretical models of Berndt et al. and Stevens & Raybould, while taking into consideration the criticisms of Karen Collins around creating a sense of direction in the development of the music.

The first version of the engine developed for the opening area of the game provided insight on the challenges that emerge from the process of composing music in a stochastic recombinant context. The second version of *The Village* engine added the use of silence within each layer as well as shifted the phrasing of each cell in order to create a flexible structure that generated more indeterminate orchestrations. Moreover, *The Village* v2 added an alternate recombinant composition to accompany intense battle action in a similar but more detailed way than the Stevens & Raybould proposed model of using meta controls to alternate between recombinant compositions. The last version of *The Village of Dion* expanded the system with new cells and layers and implemented Berndt's sequential block distribution concept, which added and removed cells from the selection pool available to the recombinant system according to the position of the player within the general level or to the achievements of individual objectives within the game's narrative.

*The Forest* area implemented a recombinant system that switched between two alternate sets of cells to follow the indeterminate action of the final battle with the goddess Artemis. *The Caves* level experimented with a new variation of the engine in which asynchronous cells

were added to the music according to the distance of enemies emerging in the darkness of the caves to create indeterminate orchestral textures as well as maintaining an element of surprise.

The *Hades Underworld* level proposed the idea of intensifying the connection between gameplay and music by alternating between cell sets according to the type of encounters that the player has during his exploration of the underworld. The sub-areas *Lethe* and *Phlegedon* offered another example of the use of asynchronous cells, combined with linking the structure to different gameplay events such as the progress of the player within the labyrinth or the distance between the player and the flames of Hades.

*For Helen* and *Ares* battle tracks implemented a horizontal resequencing system that created variation by allowing alternate starting points for each composition. The recombination of each section in *For Helen* was fixed in order to ensure a particular course in its harmonic development, while it was left open in *Ares* as the piece used cyclical phrasing over static harmony. This chapter also examined two compositions that were created for a recombinant system but were ultimately implemented linearly into the game: *Atlantis* was composed with the intention of using a recombinant model identical to *The Village* but was left out due to time restrictions, resulting in a bizarre and non-dynamic accompaniment. *Road to Troy* was composed as solo guitar piece that made use of extended chords but was left out due to the difficulty of creating natural transitions between each cell. The next chapter will evaluate the limitations of these developments and investigate possible future directions for further improving the use of recombinant cells in games.

## CHAPTER 8: CONCLUSION

### 8.1 Limitations of the recombinant techniques in *Apotheon*

#### Musical direction

As Karen Collins has previously emphasized in her work, one of the bigger challenges of recombinant music is the difficulty of creating a sense of development and direction.

According to Collins, the lack of direction leads in turn to a secondary problem which is the elimination of the dramatic curve, causing the music in a game to become static or even be perceived as an “aural wallpaper” or a series of remotely connected events.<sup>195</sup> As discussed in chapter 3, this issue was evident in earlier games that utilised recombinant techniques such as *Legend of Zelda: Ocarina of Time*, where the recombinations remained unchanged as the game progressed. A potential solution to this problem can be found by looking into the work of the British experimental composer James Saunders who often composes open form music inspired by games. Saunders states that “The thing which draws me to games as a basis for music (apart from the fact they are fun) is the sense of purpose they present”.<sup>196</sup> Saunders argues that composing open form music as part of a game motivates performers towards a specific goal and avoids the creation of arbitrary endings: “Goals provide completion, purpose and, perhaps most usefully, a meaningful end condition”.<sup>197</sup> As demonstrated in chapter 7, it is the connection between the pursuit of goals (called quests in a videogame context) and the generation of recombinant music that can provide the necessary sense of direction for the music in *Apotheon*. Although connecting the music towards a certain quest

---

<sup>195</sup> Collins, *Game Sound*, pp 158-160.

<sup>196</sup> Saunders, James. “Do The Best You Can” *James Saunders*. N.p., 2017. Web. 22 Aug. 2017. <<http://www.james-saunders.com/2017/01/08/do-the-best-you-can/>>.

<sup>197</sup> Saunders, James. “End Condition” *James Saunders*. N.p., 2016. Web. 22 Aug. 2017. <<http://www.james-saunders.com/2016/12/30/end-condition/>>.

might be a successful approach in that it provides direction, it might be too complex to achieve within a larger open world game that might include hundreds of main and side quests within a single level, which the player might choose to pursue in any order. For example, according to a website that provides assistance for completing *World of Warcraft* quests, there are 23,086 unique quests that have been registered by players in that particular game.<sup>198</sup> Moreover, this relationship might be problematic if musical and narrative development do not occur at an appropriate pace.

In *Apotheon's Village of Dion* level, as long as the player moves through different locations and completes different quests the music evolves correspondingly and avoids the goal-oriented difficulties found in earlier recombinant game soundtracks. However, if the player gets stuck in a particular point in the game the rules governing the recombinations will remain static and the music will stop changing. Composers have frequently dealt with such problems in non-recombinant soundtracks by fading to silence. In similar unchanging gameplay situations, *Apotheon* uses silence randomly across all layers resulting in a texture that is never completely still as it varies in time by constantly employing a different number of layers. The use of variable layers is useful but such a technique can only be temporarily effective if the thematic material within each layer does not develop. Therefore, if a player spends an extended period of time in *The Village of Dion* area without progressing fast enough through the objectives, then the lack of significant progress in the music will eventually make the recombinations unsurprising and the dramatic curve will gradually be eliminated.

---

<sup>198</sup> "Quests." Wowhead. Web. 22 Aug. 2017. <<http://www.wowhead.com/quests>>.

It is worth drawing a parallel here with how a similar problem is approached by game developers when designing open form narratives. Developers use both linear and nonlinear elements in different degrees, since avoiding any form of linearity in the gameplay structure would cause difficulties in having any sort of coherent narrative. Furthermore, this would require a vast amount of programming work in calculating all the possible outcomes of each action making the task nearly impossible.<sup>199</sup> In his article “The Myth of Non Linearity”, Wilks makes an interesting point that even open world games that reputedly give players the complete freedom to create their own stories are in some level linear: “the true non-linear game is nearly impossible to achieve due to the fact that if you have an end point to the game or some kind of win scenario, the game is by definition linear, as it has a defined beginning and end point.”<sup>200</sup> Every open world game uses linear and nonlinear aspects in order to find a balance between offering more freedom to the player and having a stronger narrative that will keep the player interested and immersed within its gameworld.<sup>201</sup>

The same principles used by game developers for nonlinear narration could apply to recombinant music systems by forcing its development in fundamental points. Many open world games include certain predefined sections that are incorporated in the open structure to ensure that the narration would have some meaningful direction and development. As mentioned in chapter 2.4, the dice game K516f attributed to Mozart included fixed passages in specific number of bars to ensure that strong cadences will occur at the ending of each phrase.<sup>202</sup> In the same way, certain musical devices could be applied in order to ensure that there is a sense of musical progress regardless of any developments in the gameplay, i.e. after

---

<sup>199</sup> Wilks, Daniel. "The Myth of Non-Linearity." *Metro Magazine: Media & Education Magazine* 144 (2005), p.124.

<sup>200</sup> Wilks, D., (2005), p.125.

<sup>201</sup> Plante, Chris. "Opinion: 'All The World's A Sandbox!'" *Gamasutra*. N.p., 2016. Web. 17 Dec. 2016. <[http://www.gamasutra.com/php-bin/news\\_index.php?story=18545](http://www.gamasutra.com/php-bin/news_index.php?story=18545)>.

<sup>202</sup> Ariza, C., 2011, p.45.

a random period of time, new cells can be introduced in the selection pool that expand on the musical ideas of the foundational cells even if nothing has changed in the gameplay. It is interesting to note that the Peter Langston algorithm developed for *Ballblazer* incorporated a similar idea. In order to ensure that the guitar solo generated had a sense of musical progress, the occurrence probabilities were altered at certain points in time, creating the impression of music progressing through different sections. Although such an approach is not related to the development of the gameplay it could be a safety switch in case the gameplay becomes stationary or progresses too slowly.

### **Musical Contrast**

Stevens and Raybould identified that the use of chance in the generation of recombinant musical structures can potentially lead to predictable results:

Aleatoric techniques are very effective for producing “ambient” music that does not feel too repetitive. However, the nature of randomness is that it can be quite predictable—predictably random if you like. This can lead to textures that sound “samey” or “noodly” and lacking in dynamic change.<sup>203</sup>

Although the output of stochastic systems is varied in many cases it can eventually become predictable, especially if lacking sufficient contrast. For example, the long awaited procedurally generated universe of the video game *No Man's Sky* with the advertised 18 quintillion unique planets has been received with massive disappointment from players across the world, as the flora, fauna and surface of each procedurally-generated planet quickly becomes repetitive and unexciting.<sup>204</sup>

---

<sup>203</sup> Stevens and Raybould, D., et al., *The Game Audio Tutorial*, p.234.

<sup>204</sup> The game received a rating of 5 out of 10 and highly negative reviews from 75,402 Steam Players. "No Man's Sky on Steam." *Store.steampowered.com*. Web. 9 Aug. 2017. <[http://store.steampowered.com/app/275850/No\\_Mans\\_Sky/](http://store.steampowered.com/app/275850/No_Mans_Sky/)>.



To avoid predictable recombinations there needs to be adequate contrast between them, a task that is not easily achievable as it imposes limitations on the musical language of the original thematic material. In order to ensure cell compatibility and consistency, restrictions must be applied to the majority of the musical features of the individual cells. Overall, the more contrasting the original material are, the harder they are to recombine with each other thus limiting the number of possible recombinations available. This is possibly the reason why the original material in many of the 18<sup>th</sup> century dice games was limited to the same key, or the 14 hours of recorded music in *Red Dead Redemption* were all in 130 bpm and in the key of A minor. These restrictions are not universal but are dependent on the musical language employed in each system. As discussed in chapter 7, different compositional methods were used to ensure cell compatibility in different recombinant compositions in *Apotheon*. For example, in *The Village of Dion* all the cells had proportional lengths to each other in order to stay in sync with the main pulse of the track. Also, battle cells were composed in double tempo compared to ambient cells to ensure smooth transitions between different game states. On the contrary, in *The Caves*, cells were triggered at random timing and their length was irrelevant as the music did not follow a steady pulse. Similarly, different methods were incorporated to ensure that all recombinations were harmonically compatible. The majority of recombinant compositions in *Apotheon* avoided functional harmony and consisted mainly of monophonic cells in different modes that were combined over static pedal notes. Compositions that were based on cyclical chord progressions, such as *For Helen*, offered a limited amount of possible recombinations in order to ensure a coherent outcome. In order for a recombinant system to generate new harmonic progressions, a musically aware algorithm needs to be incorporated.

## 8.2 Future directions

There is a lot of scope for experimentation and future development for a recombinant system to overcome the aforementioned limitations and a) have a stronger sense of direction and thematic development b) generate more contrasting and complex variations c) be able to adapt to gameplay changes at a deeper level, and d) be able to adapt to gameplay changes faster. The music composed in *Apotheon* was designed to be adaptive solely to gameplay parameters and did not calculate recombinations based on musical outcome. In order to create meaningful compositions, this issue had to be dealt with by composing musically coherent cells, an approach that as discussed results in limiting the space for musical contrast and thematic development. If the algorithm is designed to become more musically aware this would allow the composer to be more flexible in the composition of their original material and could allow for more diverse musical results and greater complexity.

David Cope developed a variety of solutions towards creating an algorithm that determines which recombinations would produce a more musical result by using techniques such as pattern matching, hierarchical analysis and reassembling according to augmented transition networks (ATM).<sup>205</sup> It is important to note that Cope developed these techniques in order to connect a great number of pre-existing motifs from the work of classical composers.

Although their implementation in a *recombinant cells* system could be advantageous, it could also create certain problems. The EMI algorithm was modified in order to emulate the musical style of particular composers and generate stylistically appropriate musical results. Therefore, such an algorithm is stylistically specific to a particular musical language and would push all recombinations in a specific direction. Modifying the algorithm according to

---

<sup>205</sup> see Cope, D. "Recombinant Music", 1991, pp. 22–28.

the style of each specific composition would be a necessity but would also require additional time and programming knowledge from the composer.

### **Markov Chains**

Another area that appears to be very promising for improving the harmonic capabilities of the system is the use of Markov chains. One of the biggest problems of the current system, as has repeatedly been noted, is the lack of control in the development of the music. The music that the current system generates does not have any relation to what has happened before musically and therefore lacks any sense of significant change or movement towards a specific harmonic goal unless this is dictated by a corresponding development in the gameplay. By using Markov chains, the probability of future musical events occurring in the sequence would also depend on the occurrence of previous events, thus giving the structure of the music a sense of chronological progression.<sup>206</sup> Markov chains have been used extensively in computer music and could provide a viable solution to controlling the structure of longer compositions.

In a first order Markov chain, only the current state affects the choice of the next event.<sup>207</sup>

The recombinant systems in *Apotheon* did not use Markov chains. Cell selection probabilities were altered dynamically according to gameplay input and were not affected in any level by the history of previously played cells. As it can be seen from appendix D the occurrence probabilities in *Village of Dion* are static and are only altered by different quests or battle events. In Markov terms, such a system can be described as “memoryless”.

---

<sup>206</sup> Overill, Richard. "Information theory." *Grove Music Online. Oxford Music Online.* Oxford University Press. Web. 10 Aug. 2017. <<http://0-www.oxfordmusiconline.com.wam.city.ac.uk/subscriber/article/grove/music/13791>>.

<sup>207</sup> Sapp, Craig Stuart. "Digital Music Programming II: Markov Chains." *Peabody.sapp.org.* N.p., 2003. Web. 9 Aug. 2017. <<http://peabody.sapp.org/class/dmp2/lab/markov1/>>.

To demonstrate how Markov chains could be employed to create harmonic relationships and harmonic direction in a recombinant system I am going to use a hypothetical example of two cells based in different keys from *Apotheon*, one in C# minor and one in G minor. According to the recombinant engine implemented in the game if both cells were equally important to the composition, then a 50% probability would need to be assigned to each. The outcome would be a random sequence including frequent shifts between both cells with rare occasions of the same cell being triggered multiple times. If however I wanted to limit the system to remain within one particular key but also allow the rare possibility of modulating to the other then this would be impossible without the use of a Markov chain. In order to introduce a connection between previous played cells a simple first order Markov chain can be applied as seen in figure 8.1:

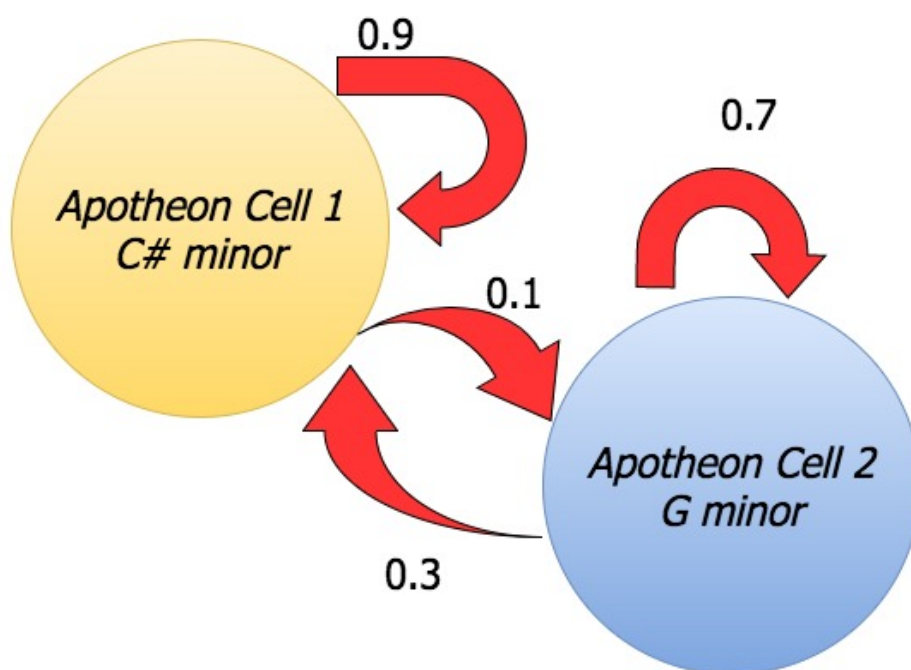

**Transition Matrix**

	Cell in C# minor	Cell in G minor
Cell in C# minor	90%	10%
Cell in G minor	30%	70%

Figure 8.1: A hypothetical first order Markov chain between two cells in *Apotheon*

In the above example, the cell currently selected would affect the choice of the next selection. If the cell in C# minor is playing, then it is very likely (90%) that the same cell will be triggered again and only 10% likely that it will move to the Cell in G minor. However, once the system moves to G minor it will have a 70% chance of repeating the same cell and a 30% of returning to C# minor. From the above it can be observed that implementing a first order Markov chain would generate more elaborate harmonic relationships between each cell than the system implemented in *Apotheon*.

However, if we extend this technique to more complex compositions such as the one created for *Village of Dion* then the implementation of Markov chains is not as straightforward. A larger transition matrix would be needed to define how the occurrence probabilities would be altered according to every possible transition between each of the five cells. If this is applied to only one layer at a time and with only a first order chain as in figure 8.2 below, then it is easily achievable.

	Cell 1	Cell 2	Cell 3	Cell 4	Cell 5
Cell 1	0%	10%	50%	5%	35%
Cell 2	35%	14%	26%	15%	10%
Cell 3	20%	25%	5%	50%	0%
Cell 4	80%	5%	5%	5%	5%
Cell 5	10%	20%	10%	30%	30%

Figure 8.2: Hypothetical transition matrix for a First-order Markov chain for the *Oracle* cells in *Village of Dion*

Such an approach could potentially reduce the “aural collage aesthetic” mentioned by Karen Collins by providing a stronger harmonic relationship between generated recombinations without needing a drastic change in the system caused by gameplay input. However, extending this relationship further by adding more complex Markov chains would require extended transition matrices to be created. A third order chain would use the current and last

two cells in the sequence to determine the choice of the next cell, but for the same *Oracle* layer would require a transition table of five columns and 125 rows ( $5^3$ ) to cover all possible sequences.

Furthermore, if they are applied to both horizontal and vertical layers simultaneously then the complexity increases exponentially and appears to be unfeasible. If a simple first order Markov chain such as the one discussed in figure 8.3 was designed to incorporate all five layers of *The Village of Dion* then the transition matrix would need to be  $5^5 = 3125$  rows long to cover all possible transitions. In the context of algorithmic composition, composers that use higher order Markov chains to generate harmonic material frequently face similar problems since it becomes progressively more difficult to populate corresponding transition matrixes as the order increases.<sup>208</sup> A common solution is the implementation of various methods of automated analysis of pre-existing material that in turn produce a computerized generation of the transition matrices. Such an approach is particularly useful when creating an algorithm that generates music in the style of a pre-existing corpus such as in the work of David Cope, but might be more difficult to apply if the harmonic relationships need to be originally defined without a prior reference point. Perhaps a potential solution would be to import a variety of pre-existing harmonic vocabularies in middleware software, and allow composers to modify the ones that are more suitable to their style. Hidden Markov Models (HMMs) might be another solution for someone with the appropriate programming expertise as they have been used in computer music to generate complex harmonic progressions.<sup>209</sup>

---

<sup>208</sup> Crocker, Timothy. "Building A Better Bach with Markov Chains." *Cs.middlebury.edu*. N.p., 2015. Web. 9 Aug. 2017. <<http://www.cs.middlebury.edu/~tecrocker/impproj/>>.

<sup>209</sup> Stellenbosch, Brink van der Merwe, and Walter Schulze. "Music Generation with Markov Models." *IEEE MultiMedia* 3 (2010): 78-85. Web. 17 Dec. 2016. <<https://www.computer.org/csdl/mags/mu/2011/03/mmu2011030078-abs.html>>.

Nonetheless, Markov chains do not need to be implemented fully across all layers in order to be effective in a recombinant system. For example, a composition can feature higher order chains to determine recombinations only on its melodic layers while the percussion or pedal layers can be memoryless. Or higher order Markov chains can be employed across multiple layers but the system can be simplified by only keeping track of the previous states within each layer independently. This an approach would result in more interesting horizontal recombinations and, as long as the cells are vertically compatible, it would not result in conflicting variations.

### **Micro Cells**

Lastly, another technique that can greatly assist in improving the capabilities of recombinant systems by increasing the connection between music and gameplay would be the use of micro cells that is an extension of the idea of Troels Folmann's micro-scoring. Folmann's technique was based on scarcely triggering short motifs that due to their harmonic ambiguity, were easy to implement with other layers. Such a technique can be taken further by using cells that would be even shorter in length, for example only a semiquaver in length, but will stochastically recombine to form larger structures (see figure 8.3). This will allow the system to be highly adaptive to gameplay details as well as avoid the problem of delayed transitions. Such a technique could have been utilized in *Apotheon* simply by using proportional microcells in percussion layers that would not have caused any harmonic clashes with the rest of the layers. However, in order for microcells to work on pitched layers they would need to be used in conjunction with a musically aware algorithm. This approach would be challenging but would also greatly expand the generative capabilities of the engine as recombinations of micro cells could lead to the generation of new melodies and themes, an

outcome that is impossible to achieve with the use of regular cells that consist of pre-composed phrases.

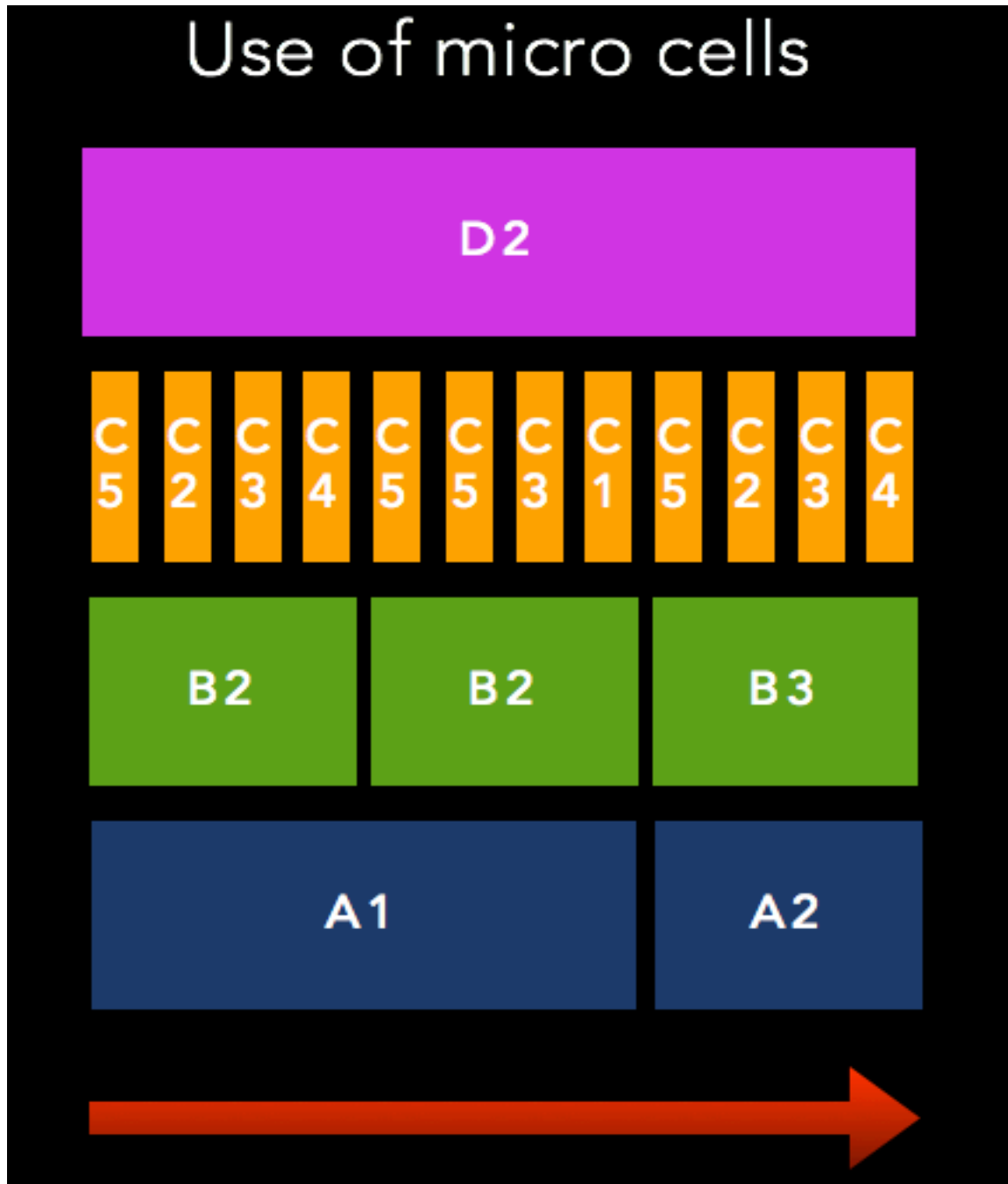

Figure 8.3: Micro Cells model designed for *Apotheon*. Each micro cell is recombined to form larger themes in a 3/4 bar. Micro cells on layer C have a duration of one semiquaver, micro cells on layer B have a duration of a crochet, and micro cell D2 lasts for the entire bar.



### **8.3 Contribution to knowledge**

The purpose of this research was to explore the use of recombinant techniques as a solution to the problem of extensive use of musical looping that is prominent in large videogames.

The research question was explored through the composition of a portfolio of pieces for the videogame *Apotheon* as well as through the written component of this thesis. This thesis is the first major study of recombinant music within a gaming context as well as one of the few extended studies that focus on the problem of musical repetition in video games. The main findings of the research are summarised below:

In Chapter 1.1 I discussed the views of a number of game composers and game audio authors that have suggested that extensive use of looping diminishes the player experience by causing listening fatigue and revealing a lack of connection between gameplay and music. Research from the field of psychoacoustics suggests that listening fatigue is a complex phenomenon that is dependent on multiple factors such as the complexity of the looped material, the musical taste of the listener, the musical perception of the listener, and the number of repetitions among other factors. To explore the effects of looping on player experience in chapter 1.2 I used the MMORPG *World of Warcraft* as a case study as it is accompanied by a highly repetitive soundtrack and an extended gameplay experience that can last up to a few years. I conducted a short player survey using 27 participants and researched relative data from larger surveys to find that the music eventually had a negative effective for the majority of players who eventually switched it off or replaced it with custom made playlists. To avoid this problem other large MMORPGs such as *Star Wars: The Old Republic* embraced the use of silence and used music sparingly. This approach was also received with criticism from some players who felt that the game needed more music.

In Chapter 2.1 I examined the use of recombinant techniques such as horizontal resequencing and vertical layers. By using video footage from the dynamic engine *PSAI*, I argued that such techniques assist in providing an adaptive experience but if a stochastic element is not introduced in their implementation they do not necessarily assist in reducing repetition and in some cases they can augment it. This is primarily due to the fact that the underlying triggers that control the structure of the music can often become predictable and repetitive themselves, an issue that Huiberts has identified as one of the major barriers to player immersion.<sup>210</sup> Therefore, I concluded that the use of stochastic methods needs to be implemented to create indeterminate recombinations that can introduce variability.

In chapter 2.2, I traced the use of such techniques in the aleatoric compositions of the classical tradition. The 18<sup>th</sup> and 19<sup>th</sup> century musical dice games attributed to well-known classical composers such as Haydn, Mozart and C.P. Bach were early examples of simple recombinant compositions that generated a large amount of variation from a small amount of original material through the use of chance. Mozart's dice game *Köchel 516f* was analysed to observe how the composer treated the original material to ensure a consistency between the 11<sup>16</sup> possible unique variations. The composition used a fixed harmonic progression throughout all recombinations and limited the possible cadences into only one option. Furthermore, in chapters to 2.3 and 2.4 I examined compositions by 20<sup>th</sup> century composers whose work incorporated chance such as Cage, Stockhausen, Boulez, Zorn and others. Some of the techniques used by these composers can be applied to a videogame context if the role of the aleatoric musician is replaced by the role of the player. Such a relationship cannot be straightforward as the aleatoric musician makes conscious musical choices while the player does not. However, through the use of an intelligent audio engine and with the inclusion of

---

<sup>210</sup> Huiberts, Sander, 2010, p.106.

stochastic methods such a relationship can become less direct and produce interesting musical results while remaining connected to the development of the gameplay.

In chapter 3, I examined how game composers have utilized stochastic recombinant techniques in the past in response to hard drive limitations of the time, and evaluated their effectiveness in reducing repetition. Games such as *Ballblazer*, *Times of Lore* and *Legend of Zelda: Ocarina of Time* successfully introduced variability into their music by manipulating smaller thematic segments in simultaneous horizontal and vertical stochastic recombinations but failed to adapt to narrative changes and lacked a sense of development over larger periods of time. More recent games such as *Tomb Raider: Legends* and *Red Dead Redemption* created a stronger adaptive experience by using highly recombinant structures that were dependent on player input. However, because of the limited use of stochastic techniques they did not introduce significant musical variation as the earlier recombinant examples.

In chapter 4 I examined two theoretical recombinant game music models proposed by Axel Berndt et al., and Raybould and Stevens. Many of the suggestions found in these models had already been implemented in the aforementioned games but there were some novel ideas to be found: 1) Berndt's proposal of sequential block distribution based on adding or removing blocks from the selection pool of a recombinant engine according to gameplay action and 2) Raybould and Steven's use of meta controls that interchange individual recombinant compositions to create a sense of development that adapts to the gameplay changes. These concepts were both implemented in the *Village of Dion* level in *Apotheon*.

The observations made in the first four chapters were explored in the practical realization of a portfolio of recombinant compositions for the videogame *Apotheon* that is discussed in detail

in chapters 5, 6, and 7. Chapter 5 provided the necessary general information on the game and its storyline to assist the reader in understanding the overall context of the portfolio. The collaboration with the game's designers provided me with the framework to experiment with recombinant techniques and use of elements from ancient Greek music to co-create a custom made recombinant system for the game. In chapter 5.3, I presented a number of positive reviews of the resulting soundtrack from online magazines, competitions, newspapers, and individual player reviews in the platform Steam, to illustrate the fact that the music of the game was received very well despite being generated in part by a recombinant system. In section 5.5 I discussed my decision to avoid the use of a historically accurate recreation of ancient Greek music due to: 1) the purpose of the game being entertaining rather than educational, 2) the difficulty of communicating emotional meaning and supporting the narrative to a target audience that would largely be unfamiliar with a 2500 year-old musical language with alternate tuning systems, and 3) the lack of clarity on how ancient Greek music actually sounded like. In chapter 5.6 I discussed how different elements of the musical language of the game were inspired by research on ancient Greek music. Primarily, I discussed the use of irregular metre, use of contemporary instrumental associations with ancient Greek instruments, and use of scales such as the half step whole step octatonic, the dominant Phrygian and the harmonic minor. In Chapter 5.7 I placed *Apotheon* within the wider ancient Greek game and film music repertoire, and discussed how other composers recreated archaic features in their music such as Tyler Bates use of irregular metre in *300*, or Bernard Herrmann's unconventional instrumentation for *Jason and the Argonauts*.

In chapter 6, I analysed each through-composed piece in the portfolio individually and discussed their musical features, inspiration, functions, relationship to the narrative, and connection to other compositions. This chapter contributed to the research primarily by

examining the reasons why these pieces were composed linearly in a commercial videogame project. In summary the reasons for linear composition are: 1) certain compositions were not likely to be repeated as they were one-time events (ex: boss battles) 2) shorter compositions were used as sound symbols to signify particular meanings that might be convoluted with the use of stochastic methods 3) due to the extensive time commitments of recombinant systems other compositions that were more central to the game were prioritized, and 4) in crucial events that were not likely to be repeated I wanted to have full control of the musical accompaniment (ex: final battle of the game against *Zeus*).

In chapters 7.2 to 7.4 I discussed in detail the composition, development, implementation, and testing of the three different recombinant systems for the opening level *Village of Dion*. The purpose of this section was to provide insight on the process and challenges of developing a large recombinant cells system for an open world level constituted by multiple quests of an unknown duration. While the outcome of the first two engines was moderately effective, this section was a key contribution to this research, since the music created by the last version was a significant step forward in the use of recombinant game music. The system offered a multi layered connection of weighted probabilities to gameplay events by implementing Berndt's sequential block distribution concept and Raybould and Stevens meta controls, which were lacking in previous recombinant soundtracks. The outcome was a music system that generates a large amount of coherent musical variations from a limited amount of pre-composed material that are relevant to the developing narrative of the game in real-time. As long as the player progresses through different quests within the area, the relationship between the engine and the narrative provides a sense of direction for the development of the music and prolongs the elimination of the dramatic curve that is evident in earlier systems.

Although *The Village* was the largest recombinant composition in the game, other recombinant techniques were explored according to the requirements of each level.

*The Forest* level consists of three recombinant compositions that were discussed in section 7.5. The main area consisted of a vertical battle layer of djembe improvisations that were triggered when a small battle occurred. The final battle with the goddess *Artemis* switched between two alternate sets of cells to follow the indeterminate timings of the battle. *The Caves* level utilized asynchronous cells that were triggered instantly in indeterminate timings and were altered according to the distance between approaching enemies. This resulted in a more adaptive musical experience that aimed to prolong the element of surprise and was better suited to the abstract textures of the composition than the system used in *Village of Dion*. The *Hades Underworld* level discussed in chapter 7.6 was perceived as a composition that alternated between cell sets according to the type of enemy that the player faced while exploring the level. In the subareas *Lethe* and *Phlegedon* a similar asynchronous cells system to that used in *The Caves* was employed but simplified only to one layer. In *Lethe* certain percussive cells were connected to the player's progress within the labyrinth and were meant to create confusion rather than provide assistance. In *Phlegedon* dissonant cymbal scratches were linked to the distance between the player and the rising flaming river. These compositions were easier to realise harmonically within a recombinant system as the dissonant textures did not impose strict limitations on possible recombinations.

In contrast, the compositions discussed in section 7.7, *For Helen* and *Ares*, were written with a particular harmonic development in mind and were therefore implemented using a horizontal resequencing system that created variation by randomizing the starting points for each part of the composition. The portfolio also consisted of three recombinant compositions

that were subsequently implemented linearly in the game. The composition *Atlantis* was initially composed with the intention of using a recombinant model identical to *The Village* as it featured memorable thematic material that was meant to reflect different parts of the level. However, being a last minute addition to the game it was implemented as a linear loop which created an odd experience as the piece remained static over multiple changes in the narrative. *Road to Troy* is a solo guitar piece that was based on extended chords that are connected with elaborate harmonic movements between each voice. A flowchart for a recombinant implementation of the piece was created but it was ultimately implemented as a linear loop due to the difficulty of creating satisfying transitions between recombinations.

#### **8.4 Final Words**

This thesis constitutes a step forward in recombinant game music through the theoretical and practice based research presented. The portfolio of compositions explored a range of recombinant and linear techniques that stretched out 67 minutes of original music to a continuous musical accompaniment that covers ten hours of an approximate play-through of *Apotheon* without resulting in excessive repetition. In addition, it also highlighted some of the limitations of working within such system and examined potential directions that can be taken by composers in the future. The time commitment required for the composition and implementation of similar techniques in future games indicates that such an approach is best suited for levels that consist of extended gameplay durations. The use of stochastic recombinant techniques can provide a middle ground between traditional composition and generative methods that allows composers to generate meaningful variations of their work and avoid the use of excessive repetition without relinquishing control of the composition of their original thematic material.

Video games have evolved from bleeping pixels in the 1970 arcades to the vast procedurally generated 3D worlds that can be already experienced through Virtual Reality titles. As the technological complexity of games reaches new heights, dynamic videogame music must follow, since it appears irrational to accompany such an open ended interactive medium of storytelling with a predetermined musical solution. It is an exciting possibility that more game composers might search for inspiration in the fields of algorithmic composition and aleatoric music to support open world videogames in the future. Due to the complexity of the field, composing with algorithms requires a different training background than the traditional film scoring education that is given to many aspiring game composers. Educational programs need to incorporate procedural techniques as part of their curriculum in order to prepare students for the different challenges that game music presents.

Jesper Kyd, one of the most commercially successful video game composers, was asked in an interview “if he was intimidated by the possibility of algorithms replacing game composers in the near future” to which he answered “No, because an algorithm cannot have a troubled childhood”.<sup>211</sup> Despite his good humoured response, this question highlights the common misconception that suggests algorithms can generate music without human input. As algorithms cannot (yet) create themselves, the principal guidelines governing the generation of the music need to be set by a composer and, within a gaming context, influenced by the actions of the player. Brian Eno compares algorithmic composition to gardening, “we're providing a set of seeds more than anything else, but those seeds were already designed elsewhere and they were already given that initial kickstart of creativity there. It's a very unusual type of creativity, it's quite open-ended.”<sup>212</sup>

---

<sup>211</sup> Kyd, Jesper. "Game Music Connect." London, 2015. Presentation.

<sup>212</sup> Steadman, Ian. "Brian Eno on Music that Thinks for Itself." *Wired*. N.p., 2016. Web. 17 Dec. 2016. <<http://www.wired.co.uk/news/archive/2012-09/28/brian-eno-peter-chilvers-scape>>.



## APPENDIX A: GLOSSARY OF VIDEOGAME TERMS

**AAA game:** The gaming equivalent of a Hollywood blockbuster. An informal classification pronounced “triple A” for games that are released by major studios and have a high development budget.

**Audio Middleware:** A type of software that works along with a game engine and controls the behavior of audio assets.

**Augmented Reality:** The use of computer generated content that is superimposed over real world events to form parts of a game. A recent example is the 2016 videogame *Pokémon Go*, developed by Niantic for iOS and Android, which used location based GPS data and the phone’s camera to create virtual creatures at the same real world locations as the player.

**Boss:** A unique enemy in a video game that is harder to defeat and is typically encountered towards the end of a level.

**Campaign mode:** A type of gameplay that is based on following a storyline.

**Console:** A hardware device designed for gaming. E.g. Sony PlayStation or Microsoft Xbox.

**Continuous Modulator node:** A node within Unreal Engine which allows parameter based manipulation of pitch and volume.

**Fmod:** A cross platform sound engine for video games developed by Firelight Technologies.

**Level:** An area within a video game world.

**Looping node:** A Node within Unreal Engine which repeats the same track.

**Loot Drops:** The rewards given to a player after defeating an enemy.

**Main quest:** A primary objective within a video game that needs to be completed in order for the storyline to continue.

**Map Layouts:** The design of an area within a video game world.

**MMORPG:** Abbreviation of Massively Multiplayer Online Role Playing Game, a video game genre in which a large number of players assume the roles of a character and interact

with each other within a virtual online world.

**One-shot:** A music track that only plays once and does not loop.

**Open World game:** A type of game in which players have the freedom to approach the game content in multiple ways. Also known as Sandbox Game.

**OST:** Abbreviation of Original Soundtrack, a commercial musical album that consists of original music written for a film or videogame.

**Platform game:** A video game genre in which players jump or climb between various platforms in a 2D game world.

**Play-through:** Playing a video game from start to finish.

**Play-test:** Playing a game for testing purposes before releasing it commercially.

**Real-time:** At the same time as a process or event occurs.

**Replayability:** The suitability of a game to be played more than once after it is completed.

**RPG:** Abbreviation of Role Playing Game, a video game genre in which players assume the role of a character within a fictional storyline.

**Quest:** An objective within a video game that can offer rewards or is necessary for the development of the narrative.

**Side quest:** An optional objective within a video game.

**Sound Cue:** An audio asset within Unreal Engine 4 that controls the behaviour of audio playback.

**Sound Event:** An audio asset within Unreal Development Kit that controls the behaviour of audio playback.

**Steam:** A popular digital distribution gaming platform for PC, Macs and Linux, developed by Valve Corporation.

**Sublevel:** A smaller section of larger area within a video game.

**UDK:** Abbreviation of Unreal Development Kit, a development kit for Unreal Engine 3

developed by Epic Games.

**UE4:** Abbreviation of Unreal Engine 4, a cross platform game engine developed by Epic Games.

**Virtual Reality:** A technology that has recently started to be used in commercial games in which the player is immersed in a 3D world with the use of a motion sensor helmed and other electronic equipment. Examples include PlayStation VR, HTC Vive, and Oculus Rift.

**Wwise:** Abbreviation of Wave Works Interactive Sound Engine, a cross platform sound engine for video games developed by Audiokinetic.

## **APPENDIX B: *WORLD OF WARCRAFT* SURVEY**

Answers from the survey conducted on the Facebook Group *Our Own Private Diablo III Gaming Group* about the music of *World of Warcraft*. Please note that the original answers were in Greek and have been translated by me. Only comments that were relevant to the survey have been included below.

Original post by Marios Aristopoulos:

Fellow gamers,

I am analysing the music engine of *World of Warcraft* for my PhD research and would like your help. What has your experience been with the music of the game so far? Do you have any memories of a theme from a specific zone or a boss fight? Please indicate your age, total time played, and if you are currently an active player.

Answers received from survey participants:

**Participant 1:** I remember getting super excited about the music of the Ragnaros final boss battle (Male 28 years old).

**Participant 2:** I always had the music turned off since the beginning of the game (Male).

**Participant 3:** The music did not seem to change apart from when entering a city or an instance. At first I liked having it in the background but as with the rest of the content in the game, if it is not updated it becomes boring, especially when it does not adapt to your what you are doing. The rest of the sound effects and dialogue were nothing special (Male 27 years old, 55 days played).

**Participant 4:** Tsouki Tsouk is lying, he just listens to Pink on top of the game for the whole time (Male).

**Participant 5:** As any serious player does, I had turned the music off in the final stages of the game. I was amazed by the epic feeling created by the soundtrack in certain battles in the last expansion Cataclysm (Male 31 years old, 90 days played).

**Participant 6:** Joking aside, music in Northend was amazing as it was more classical based (Female).

**Participant 7:** In the beginning I was fascinated with the music and enjoyed listening to it. After countless hours of playing it became dull and I decided to turn it off completely. I

preferred listening to the ambient sounds of the zones such as birds and water streams rather than the repeating music (Female 29 years old, 61 days played).

**Participant 8:** I think that music changes according to the area that you are in and I believe it fits the style well, especially in the elvish locations. As there is no combat music I use plugins that allow me to input my own playlists according to what is happening (combat, boss fight, level up, death, victory, etc) (Male 26 years old, 90 days played).

**Participant 9:** I enjoyed listening to the music as I was leveling in the game but turned it off in the final stages of the game (instances, raids etc). I liked the fact that the music would fit the ambience of the zone that you were, depending on the race, history and culture of the area (Male 26 years old, 40 days played).

**Participant 10:** I have been playing WoW for 6 years now and I am still raiding. The music fits the game but as the others mentioned it is easily repeatable. After the 1<sup>st</sup> year I have it strictly off as I need to listen to the SFX which are much more important in understanding your surroundings and respond in time. All the boss music was the same but I enjoyed the fact that they had new music with each expansion with the Northend theme being my favourite (Male 35 years old).

**Participant 11:** I only played WoW for a little time and the music never bothered me (Male 23 years old, 5 days played).

**APPENDIX C: APOLLO'S PALACE TRANSCRIPTION**

Marios Aristopoulos  
**Apollo's Palace**  
**APOTHEON OST**

**INSTRUMENTATION**  
**Transcribed for the FHS Orchestra**  
**Frisco High School, Texas**

F Horn 1 (written in concert pitch)  
F Horn 2 (written in concert pitch)  
F Horn 3 (written in concert pitch)  
Trombone 1  
Trombone 2  
Timpani  
Cymbals  
Snare Drum  
Violin 1  
Violin 2  
Viola  
Violoncello  
Contrabass

**A**  $\text{♩} = 110$

Cymbals  $\text{p} \rightarrow \text{mf}$

Snare Drum  $\text{mf}$

Violoncello  $\text{mf}$

Double Bass  $\text{mf}$

Tbn.  $\text{mf}$

S. D.

Via.  $\text{mf}$

Vc.  $\text{mf}$

Db.  $\text{mf}$

**B**

Hn.  $\text{mf}$

Tbn.  $\text{mf}$

S. D. **B**

Via.  $\text{mf}$

Vc.  $\text{mf}$

Db.  $\text{mf}$

**16**

Hn.  $f$

Cym.  $\text{p}$

S. D.  $f$

Via.  $f$

Vc.  $f$

Db.  $f$



22 **C** 3

Tbn. *f*

Cym. *f*

Vln. I *f*

Vln. II *f*

Vla. *f*

Vc. *f*

Db. *f*

28

Hn. *mf*

Tbn. *ff*

Timp. *mf*

Cym. *p* *z* *f*

Vln. I *ff*

Vln. II *ff*

Vla. *ff*

Vc. *ff*

Db. *ff*

33 **D**

Hn. *f*

Timp. *f*

Cym. *p* *z*

Vln. I *p*

Vln. II *p*

Vla. *p*

Vc. *p*

Db. *p*

38

Timp. *mp* *ppp*

Cym. *f*

S. D. *mp* *f*

Vln. I

Vla. *mp* *f*

**APPENDIX D: OCCURRENCE PROBABILITY TABLES FOR THE VILLAGE OF  
DION FINAL ENGINE**

**FIND THE APOTHECARY (ACADEMY) QUEST**

ambience-01, ambience-02	50% each	silence 0%
qanun-f1, qanun-f2, qanun-f3, qanun-f4, qanun-f5,	10% each	silence 50%
percussion-01, percussion-02, percussion-03, percussion-04, percussion-05	20% each	Silence 0%
battlestrings-01, battlestrings-02, battlestrings-03, battlestrings-04, battlestrings-05 <b>TRIGGERED when there is battle</b>	<b>TRIGGER</b> 20% each	silence 0%

**FIND THE BLACKSMITH (BLACKSMITH'S HOUSE) QUEST**

ambience-01, ambience-02	50% each	silence 0%
anvils-01, anvils-02, anvils-03	33.3% each	silence 0%
battlepercussion-01, battlepercussion-02, battlepercussion-03, battlepercussion-04, battlepercussion-05	20% each	silence 0%
battlebrass-01, battlebrass-02, battlebrass-03, battlebrass-04, battlebrass-5 <b>TRIGGERED when there is battle</b>	<b>TRIGGER</b> 20% each	silence 0%
Timpani-f1 <b>TRIGGERED when there is battle</b>	<b>TRIGGER</b> <b>100%</b>	Silence 0%

### FIND THE HUNTER (HUNTER'S HOUSE) QUEST

ambience-01, ambience-02	50% each	silence 0%
qanun-f1, qanun-f2, qanun-f3, qanun-f4, qanun-f5,	10% each	silence 50%
duduk-f1, duduk-f2, duduk-f3, duduk-f4, duduk-f5	5% each	silence 65%
percussion-01, percussion-02, percussion-03, percussion-04, percussion-05 <b>TRIGGERED when the crypt is opened!</b>	<b>TRIGGER</b> 20% each	Silence 0%

### SECURE THE GRANARY (GRANARY) QUEST

ambience-01, ambience-02	50% each	silence 0%
anvils-01, anvils-02, anvils-03	33.33% each	silence 0%
battlestrings-01, battlestrings-02, battlestrings-03, battlestrings-04, battlestrings-05	20% each	silence 0%
battlepercussion-01, battlepercussion-02, battlepercussion-03, battlepercussion-04, battlepercussion-05	20% each	silence 0%
qanun-f1, qanun-f2, qanun-f3, qanun-f4, qanun-f5,	10% each	silence 50%
duduk-f1, duduk-f2, duduk-f3, duduk-f4, duduk-f5	4% each	silence 80%
Timpani-f1	100%	Silence 0%

**LEAD TO THE TYRANT (WHEN ALL QUESTS ARE COMPLETED)**

ambience-01, ambience-02	50% each	silence 0%
qanun-f1, qanun-f2, qanun-f3, qanun-f4, qanun-f5,	4% each	silence 80%
Xana Battlef-1, Xana Battlef-2, Xana Battlef-3, Xana Battlef-4 Xana Battlef-5	10% each	silence 50%
Xana Shadow_01, Xana Shadow_02, Xana Shadow_03, Xana Shadow_04, Xana Shadow_05	2% each	silence 90%
battlestrings-01, battlestrings-02, battlestrings-03, battlestrings-04, battlestrings-05	20% each	silence 0%
battlebrass-01, battlebrass-02, battlebrass-03, battlebrass-04, battlebrass-5	20% each	silence 0%
battlepercussion-01, battlepercussion-02, battlepercussion-03, battlepercussion-04, battlepercussion-05	20% each	silence 0%
cymbals-01, cymbals-02, cymbals-03, cymbals-04, cymbals-05	20% each	silence 0%
Timpani-f1	100%	Silence 0%

## **APPENDIX E: CONTENTS OF THE ACCOMPANYING USB**

The game can be accessed through the Steam PC/Mac platform or the Sony PS4 store. More information for accessing the game is given on chapter 5.5

### **VIDEO EXAMPLES**

#### **Chapter 2**

2.1 PSAI Dynamic Music Test

#### **Chapter 3**

3.1 *Ballblazer* “Song of the Grid” by Peter Langston

3.2 *Times of Lore* by Martin Galway

3.3 *Legend of Zelda: Ocarina of Time* “Hyrule Field” by Koji Kondo

3.4 *Red Dead Redemption* Gameplay Footage

3.5 *Tomb Raider: Legend* gameplay footage

#### **Chapter 5**

5.1 *Apotheon* - PS4 Trailer

#### **Chapter 6**

6.1 *Apotheon* - 7.10 *Apotheon* - Maze of Athena

#### **Chapter 7**

7.1 *Apotheon* - The Village recombinant engine version 1 extract

7.2 *Apotheon* - The Village- transition from ambience to battle1

7.3 *Apotheon* - The Village- transition from ambience to battle2

7.4 *Apotheon* - Walkthrough of the entire level of Village of Dion

7.5 *Apotheon* - Artemis Boss Fight

7.6 *Apotheon* - Caves

7.7 *Apotheon* - Hades Underworld

- 7.8 *Apotheon* - Hades - Lethe puzzle
- 7.9 *Apotheon* - Hades - Phlegedon event
- 7.10 *Apotheon* - Hades - Acheron
- 7.11 *Apotheon* - Atlantis - Battle in the Island of Horses

## **APOTHEON OST**

- 01. King of the Gods.mp3
- 02. Under the Gaze of Ares.mp3
- 03. The Oracle.mp3
- 04. In the Forests of Olympus.mp3
- 05. The Deer.mp3
- 06. Apollo's Palace.mp3
- 07. Hades Underworld.mp3
- 08. March from Hades.mp3
- 09. Trojan Shores.mp3
- 10. Achilles Heel.mp3
- 11. Maze of Athena.mp3
- 12. Street musician - Welcome to the Agora.mp3
- 13. Street musician - Dance of Dionysus.mp3
- 14. Street musician - Apollo's Light.mp3
- 15. For Helen Part I.mp3
- 16. For Helen Part II.mp3
- 17. For Helen Part III.mp3
- 18. Ten Years of War.mp3
- 19. Defeat.mp3

20. Stalemate.mp3

21. Victory.mp3

22. Atlantis.mp3

23. Ares - God of War.mp3

24. Road to Troy.mp3

### **ADDITIONAL MATERIAL**

- HD jpeg format of figure 5.7 - *Apotheon* Developer's Open World Map
- Scanned copy of the score of Wolfgang Amadeus Mozart's dice game K516f



## WORKS CITED

"10 Games About Ancient Greece." *IGN Boards*. N.p., 2009. Web. 9 Aug. 2017.

<<http://www.ign.com/boards/threads/10-games-about-ancient-greece.187605563/>>.

"2015 Finalists - CVA" *CVA Awards*. N.p., 2015. Web. 17 Dec. 2016.

<<http://www.cvawards.ca/2015-finalists/>>.

Alison, Latham. "Mobile Form." *The Oxford Companion to Music*. *Oxford Music Online*.

Web. 9 Aug. 2017. <[http://0-](http://0-www.oxfordmusiconline.com.wam.city.ac.uk/subscriber/article/opr/t114/e4463)

[www.oxfordmusiconline.com.wam.city.ac.uk/subscriber/article/opr/t114/e4463](http://0-www.oxfordmusiconline.com.wam.city.ac.uk/subscriber/article/opr/t114/e4463)>.

Amin, Tayyab et al. "The 15 Best Video Game Soundtracks of 2015." *FACT*. N.p., 2015.

Web. 17 Dec. 2016. <<http://www.factmag.com/2015/12/13/best-videogame-soundtracks/11/>>.

"*Apotheon* – Gameplay Walkthrough – PS4- Part 1 – Village of Dion - Game Resource H.D."

*YouTube*. N.p., 2015. Web. 12 Dec. 2016.

<<https://www.youtube.com/watch?v=MNYiLFupyVs>>.

"*Apotheon* - Statistics." N.p., 2015. Web. 17 Dec. 2016. <<http://steamspy.com/app/208750>>.

"*Apotheon* On Steam." *Steam*. N.p., 2015. Web. 17 Dec. 2016.

<<http://store.steampowered.com/app/208750/>>.

"*Apotheon*" *Playstation®Store*. Web. 17 Dec. 2016. <[https://store.playstation.com/#!/en-](https://store.playstation.com/#!/en-gb/games/apotheon/cid=EP4525-CUSA01366_00-00ApotheonFORPS4)

[gb/games/apotheon/cid=EP4525-CUSA01366\\_00-00ApotheonFORPS4](https://store.playstation.com/#!/en-gb/games/apotheon/cid=EP4525-CUSA01366_00-00ApotheonFORPS4)>.

- Aristopoulos, Marios. "The Role of Music in MMORPGS: An Analysis of the World of Warcraft Music Engine." *Music and the Moving Image Conference, Steinhardt, NYU, 2012*.
- Ariza, Christopher. "Two Pioneering Projects from the Early History of Computer-Aided Algorithmic Composition." *Computer Music Journal* 35.3 (2011): 40-56.
- "Ballblazer (1984) (Atari-Lucasfilm Games) ROM For 5200." *Emuparadise*. Web. 19 Aug. 2017. <[https://www.emuparadise.me/Atari\\_5200\\_ROMs/Ballblazer\\_\(1984\)\\_\(Atari-Lucasfilm\\_Games\)/91726](https://www.emuparadise.me/Atari_5200_ROMs/Ballblazer_(1984)_(Atari-Lucasfilm_Games)/91726)>.
- Banas, Graham. "Feature: The Best Playstation Soundtracks of 2015." *Push Square* N.p., 2015. Web. 17 Dec. 2016. <[http://www.pushsquare.com/news/2015/12/feature\\_the\\_best\\_playstation\\_soundtracks\\_of\\_2015](http://www.pushsquare.com/news/2015/12/feature_the_best_playstation_soundtracks_of_2015)>.
- Bélis, Annie. "Aristoxenus." *Grove Music Online. Oxford Music Online*. Web. 9 Aug. 2017. <<http://0-www.oxfordmusiconline.com.wam.city.ac.uk/subscriber/article/grove/music/01248>>.
- Berndt, Axel et al. "Composition and Arrangement Techniques for Music in Interactive Immersive Environments." *Audio Mostly - A Conference on Sound in Games*. Piteå, 2006.
- Brackett, John. "Some Notes On John Zorn'S Cobra." *American Music* 28.1 (2010): 44-75. Web. 9 Aug. 2017. <<http://www.jstor.org/stable/10.5406/americanmusic.28.1.0044>>.
- Russell, Brower. "The Music of Mists: An Interview with Russell Brower." *World of Warcraft*. N.p., 2016. Web. 9 Aug. 2017. <<https://worldofwarcraft.com/en-gb/news/9762739/the-music-of-mists-an-interview-with-russell-brower>>.

Burkholder, J. Peter. "Ives, Charles." *Grove Music Online. Oxford Music Online*. N.p., 2013. Web. 9 Aug. 2017. <<http://0-www.oxfordmusiconline.com.wam.city.ac.uk/subscriber/article/grove/music/A2252967>>.

Butts, Steve. "Age of Music - IGN." *IGN*. N.p., 2002. Web. 9 Aug. 2017. <<http://uk.ign.com/articles/2002/09/06/age-of-music-2>>.

"Capsized - 2D Action Platform Game by Alientrap." Web. 17 Dec. 2016. <<http://www.capsizedgame.com/>>.

"Capsized." *Steam Store*. N.p., 2011. Web. 19 Aug. 2017. <<http://store.steampowered.com/app/95300/Capsized/>>.

Chiappini, Dan. "Q&A: World of Warcraft Composer Jason Hayes." *GameSpot*. N.p., 2007. Web. 10 Aug. 2017. <<http://www.gamespot.com/articles/qanda-world-of-warcraft-composer-jason-hayes/1100-6172231/>>.

Coates, Steve. "John H. Oakley's 'Greek Vase'." *NYTimes.com*. N.p., 2013. Web. 9 Aug. 2017. <<http://www.nytimes.com/2013/12/08/books/review/john-h-oakleys-greek-vase.html>>. © Trustees of the British Museum, made available under Creative Commons Attribution-NonCommercial-ShareAlike 4.0 International (CC BY-NC-SA 4.0).

Collins, Karen, John Richardson, and Stan Hawkins. *Essays on Sound and Vision*. Helsinki: Gaudeamus, University of Helsinki Press, 2009.

Collins, Karen. "An Introduction to Procedural Music in Video Games." *Contemporary Music Review* 28.1 (2009): 5-15. Web.

Collins, Karen. *From Pac Man to Pop Music*. Routledge, 2008.

- Collins, Karen. *Game Sound: An Introduction to the History, Theory, and Practice of Video Game Music and Sound Design*. Cambridge, MIT Press, 2008.
- Collins, Karen. *Playing with Sound: A Theory Of Interacting With Sound And Music In Video Games*. Cambridge, MIT Press, 2014.
- "The Complete History of Open World Games Part II." *Computer and Video Games*. N.p., 2017. Web. 16 May 2016.  
<<http://www.computerandvideogames.com/189599/features/the-complete-history-of-open-world-games-part-2>>.
- Cope, David, Douglas R. Hofstadter, and Eleanor Selfridge-Field. *Virtual Music*. Cambridge, Mass. [etc.]: MIT Press, 2001.
- Cope, David. "Recombinant Music: Using The Computer to Explore Musical Style." *Computer* 24.7 (1991): 22-28.
- Crocker, Timothy. "Building A Better Bach with Markov Chains." *Cs.middlebury.edu*. N.p., 2015. Web. 9 Aug. 2017. <<http://www.cs.middlebury.edu/~tecrocker/impproj/>>.
- "Definition of Apotheosis (Noun, LNS, Apotheōsis)." *Latinlexicon*. Web. 9 Aug. 2017.  
<<http://latinlexicon.org/definition.php?p1=2003804>>.
- d'Escriván, Julio. *Music Technology (Cambridge Introductions to Music)*. Cambridge, Cambridge University Press, 2011.
- Eco, Umberto. *The Open Work*. Cambridge: Harvard University Press, 1989.
- Elm, Bill, and Woody Jackson. "Red Dead Redemption Score." Rockstar Games. Web. 9 Aug. 2017. <<http://www.rockstargames.com/reddeadredemption/features/soundtrack>>.

- "ESRB." Web. 17 Dec. 2016. <<http://www.esrb.org/about/video-game-industry-statistics.jsp>>.
- Felphyre. "Soundtrack - World of Warcraft Custom Mod." N.p., 2016. Web. 17 Dec. 2016. <<https://mods.curse.com/addons/wow/soundtrack>>.
- Folmann, Troels. "Tomb Raider Legend - Scoring A Next-Generation Soundtrack". GDC lecture, 2006. Web. 14 Aug. 2017. <<http://www.gdcvault.com/play/1013234/Tomb-Raider-Legend-Scoring-a>>
- "Gamelengths - Average Play Times For Tomb Raider: Legend." *Gamelengths.com*. Web. 9 Aug. 2017. <<http://www.gamelengths.com/games/playtimes/Tomb+Raider+%3A+Legend/>>.
- Garcia, Luis-Manuel. "On and On: Repetition as Process and Pleasure in Electronic Dance Music." *Music Theory Online* 11.4 (2005): n. pag.
- Grant, M. J. *Serial Music, Serial Aesthetics*. 1st ed. Cambridge, Cambridge University Press, 2005.
- Griffiths, Paul. "Aleatory." *Grove Music Online. Oxford Music Online*. N.p., 2011. Web. 9 Aug. 2017. <<http://www.oxfordmusiconline.com.wam.city.ac.uk/subscriber/article/grove/music/00509>>.
- "Hades \*SPOILERS\*: *Apotheon* General Discussions." *Steamcommunity.com*. N.p., 2015. Web. 9 Aug. 2017. <<https://steamcommunity.com/app/208750/discussions/0/606068060828125152/>>.
- Hassan, Scheherazade Qassim, and Jean During. "Ney [Nai, Nāī, Nāy, Nay]." *Grove Music Online. Oxford Music Online*. Web. 23 Aug. 2017. <<http://www.oxfordmusiconline.com.wam.city.ac.uk/subscriber/article/grove/music/19644>>.

- Herrmann, Bernard. *Vertigo Theme*. Hal Leonard, 1958.
- Hiranand, Ravi. "18 Quintillion Planets: The Video Game that Imagines an Entire Galaxy." *CNN*. 2015. Web. 17 Dec. 2016. <<http://www.cnn.com/2015/06/18/tech/nomans-sky-sean-murray/>>.
- Hoffmann, Peter. "Xenakis, Iannis." *Grove Music Online*. *Oxford Music Online*. N.p., 2016. Web. 9 Aug. 2017. <<http://www.oxfordmusiconline.com.wam.city.ac.uk/subscriber/article/grove/music/30654>>.
- Horowitz, Steve. *Essential Guide to Game Audio: The Theory and Practice of Sound for Games*. New York, Focal Press, 2014.
- Huiberts, Sander. "Captivating Sound: The Role Of Audio For Immersion In Computer Games." PhD thesis. Utrecht School of the Arts and the University of Portsmouth, 2010.
- Summers, R., D., Timothy. "Video Game Music: History, Form and Genre" PhD thesis. University of Bristol, 2012.
- "Interview: Blizzard Entertainment Audio Team." *Blizzard*. N.p., 2014. Web. 17 Dec. 2016. <<http://speakhertz.com/6716/interview-blizzard-entertainment-audio-team>>.
- Jørgensen, Kristine. "What Are Those Grunts and Growls Over There? Computer Game Audio and Player Action." N.p., 2007.
- Kavakli, M., D. Richards, and E. Fassbender. "Game Engineering Approach to the Effect of Music on Learning in Virtual-Immersive Environments." *Proceedings of International Conference on Games Research and Development*, 4 Dec. 2006, pp. 224–230.
- "Kid Icarus (1986) NES Review - Mobygames." *MobyGames*. N.p., 2006. Web. 9 Aug. 2017. <<http://www.mobygames.com/game/nes/kid-icarus/reviews/reviewerId,44055/>>.

Kyd, Jesper. "Game Music Connect" London, 2015. Presentation.

Langston, Peter. "Six Techniques for Algorithmic Music Composition." Columbus:

International Computer Music Conference, 1988. Web. 10 Aug. 2017.

<<http://peterlangston.com/Papers/amc.pdf>>.

Latta, Westlee. "CDM Interview: Tomb Raider: Legend Composer Troels Brun Folmann on

Adaptive "Micro-Scoring"." *CDM Create Digital Music*. N.p., 2008. Web. 9 Aug. 2017.

<<http://cdm.link/2006/10/cdm-interview-tomb-raider-legend-composer-troels-brun-folmann-on-adaptive-micro-scoring/>>.

Life, Fantasy. "Why is the Music in this Game so Bad and Repetitive? - Fantasy Life

Message Board For 3DS - Gamefaqs." *Gamefaqs.com*. N.p., 2017. Web. 9 Aug. 2017.

<<https://www.gamefaqs.com/boards/971712-fantasy-life/70578512>>.

Margulis, Elizabeth Hellmuth. "Aesthetic Responses to Repetition in Unfamiliar

Music." *Empirical Studies of the Arts* 31.1 (2013): 45-57.

Margulis, Elizabeth Hellmuth. "Musical Repetition Detection Across Multiple

Exposures." *Music Perception: An Interdisciplinary Journal* 29.4 (2012): 377-385.

Margulis, Elizabeth Hellmuth. *On Repeat: How Music Plays the Mind*. New York: Oxford

University Press, 2014.

Mathiesen, Thomas J. "Rhythm and Meter in Ancient Greek Music." *Music Theory*

*Spectrum* 7 (1985): 159-180.

Mathiesen, Thomas J. "Ancient Greek Music." *The Oxford Companion to Music*. *Oxford*

*Music Online*. Web. 9 Aug. 2017. <<http://0->

[www.oxfordmusiconline.com.wam.city.ac.uk/subscriber/article/opr/t114/e260](http://www.oxfordmusiconline.com.wam.city.ac.uk/subscriber/article/opr/t114/e260)>.

- McFerran, Damien. "Review: Kid Icarus (NES)." *Nintendo Life*. N.p., 2007. Web. 9 Aug. 2017. <[http://www.nintendolife.com/reviews/vc/kid\\_icarus\\_nes](http://www.nintendolife.com/reviews/vc/kid_icarus_nes)>.
- McGonigal, Jane. "Gaming Can Make A Better World." TED. N.p., 2010. Web. 9 Aug. 2017. <[https://www.ted.com/talks/jane\\_mcgonigal\\_gaming\\_can\\_make\\_a\\_better\\_world](https://www.ted.com/talks/jane_mcgonigal_gaming_can_make_a_better_world)>.
- McKinnon, W. James. "Syrinx." *Grove Music Online. Oxford Music Online*. Web. 23 Aug. 2017. <<http://0-www.oxfordmusiconline.com.wam.city.ac.uk/subscriber/article/grove/music/27275>>.
- McKinnon, James W., and Robert Anderson. "Tympanum." *Grove Music Online. Oxford Music Online*. N.p., 2017. Web. 9 Aug. 2017. <<http://0-www.oxfordmusiconline.com.wam.city.ac.uk/subscriber/article/grove/music/28671>>.
- Moore, David. "Boucourechliev: Archipels 1-4, Anarchipel." *American record guide* 58.5 (1995): 112.
- Moulton, Carroll. *Ancient Greece and Rome: An Encyclopedia for Students Vol. 3*. Farmington Hills: Charles Scribner's Sons [Imprint], 1998.
- "Musikalisches Würfelspiel, K.516F (Mozart, Wolfgang Amadeus)." *Imslp.org*. Web. 9 Aug. 2017. <[http://imslp.org/wiki/Musikalisches\\_W%C3%BCrfelspiel,\\_K.516f\\_\(Mozart,\\_Wolfgang\\_Amadeus\)](http://imslp.org/wiki/Musikalisches_W%C3%BCrfelspiel,_K.516f_(Mozart,_Wolfgang_Amadeus))>.
- Nickell, Eric, Nick Yee, and Nicolas Ducheneaut. "Building an MMO with Mass Appeal: A Look at Gameplay In World Of Warcraft." *Games and Culture* 1.4 (2006): 281-317. Web. 17 Dec. 2016.
- "No Man's Sky on Steam." *Store.steampowered.com*. Web. 9 Aug. 2017. <[http://store.steampowered.com/app/275850/No\\_Mans\\_Sky/](http://store.steampowered.com/app/275850/No_Mans_Sky/)>.



- Osmond-Smith, David, and Ben Earle. "Berio, Luciano." *Grove Music Online. Oxford Music Online*. N.p., 2014. Web. 9 Aug. 2017. <<http://0-www.oxfordmusiconline.com.wam.city.ac.uk/subscriber/article/grove/music/02815>>.
- Overill, Richard. "Information theory." *Grove Music Online. Oxford Music Online*. Oxford University Press. Web. 10 Aug. 2017. <<http://0-www.oxfordmusiconline.com.wam.city.ac.uk/subscriber/article/grove/music/13791>>.
- Parsons, Gavin, Meaghan Connor, and Mark James. "Music and The World of Warcraft." N.p., 2017. Web. 10 Aug. 2017. <<http://www.richardcolby.net/files/Parsonsetal.pdf>>.
- "PC Longplay [357] Supaplex." *YouTube*. N.p., 2013. Web. 10 Aug. 2017. <<https://www.youtube.com/watch?v=8dMF3jU-nwc>>.
- Phillips, Winifred. *A Composer's Guide to Game Music*. Cambridge, MA: MIT Press, 2014.
- Plante, Chris. "Opinion: 'All The World's A Sandbox'." *Gamasutra*. N.p., 2016. Web. 17 Dec. 2016. <[http://www.gamasutra.com/php-bin/news\\_index.php?story=18545](http://www.gamasutra.com/php-bin/news_index.php?story=18545)>.
- Politis, Dionysios et al. "Emulation of Ancient Greek Music Using Sound Synthesis and Historical Notation." *Computer Music Journal* 32.4 (2008): 48-63.
- Pritchett, James. "Cage, John." *Grove Music Online. Oxford Music Online*. N.p., 2012. Web. 9 Aug. 2017. <<http://0-www.oxfordmusiconline.com.wam.city.ac.uk/subscriber/article/grove/music/A2223954>>.
- Putnam, Karl W., and David Cope. "Experiments in Musical Intelligence." *Computer Music Journal* 21.3 (1997): 102.
- "Quests." *Wowhead*. Web. 22 Aug. 2017. <<http://www.wowhead.com/quests>>.

Randel, Don Michael. *The Harvard Dictionary of Music*. 4th ed. Cambridge, MA. Belknap Press of Harvard University Press, 2003.

Raybould, Dave, and Richard Stevens. *The Game Audio Tutorial: A Practical Guide to Sound and Music for Interactive Games*. Amsterdam: Focal Press/Elsevier, 2011.

"Red Dead Redemption." *IMDb*. Web. 19 Aug. 2017.

<[http://www.imdb.com/title/tt1479962/mediaindex?ref\\_=tt\\_mv\\_close](http://www.imdb.com/title/tt1479962/mediaindex?ref_=tt_mv_close)>.

Richmond, Shane. "Call of Duty: Modern Warfare 3 Breaks Sales Records." *The Telegraph* 2011. Web. 17 Dec. 2016. <<http://www.telegraph.co.uk/technology/video-games/video-game-news/8884726/Call-of-Duty-Modern-Warfare-3-breaks-sales-records.html>>.

Sapp, Craig Stuart. "Digital Music Programming II: Markov Chains." *Peabody.sapp.org*. N.p., 2003. Web. 9 Aug. 2017. <<http://peabody.sapp.org/class/dmp2/lab/markov1/>>.

Saunders, James. "Do The Best You Can" *James Saunders*. N.p., 2017. Web. 22 Aug. 2017. <<http://www.james-saunders.com/2017/01/08/do-the-best-you-can/>>.

Saunders, James. "End Condition" *James Saunders*. N.p., 2016. Web. 22 Aug. 2017. <<http://www.james-saunders.com/2016/12/30/end-condition/>>.

Savage, Mark. "Gangnam Style is no Longer the Most-Played Video on YouTube." *BBC News*. N.p., 2017. Web. 9 Aug. 2017. <<http://www.bbc.co.uk/news/entertainment-arts-40566816>>.

Schechter, John, M. "Berimbau." *Grove Music Online. Oxford Music Online*. Web. 9 Aug. 2017. <<http://0-www.oxfordmusiconline.com.wam.city.ac.uk/subscriber/article/grove/music/02811>>.

Sefton, Jamie. "The Roots of Open-World Games." *Games Radar*. 2008. Web. 17 Dec. 2016.

<<http://www.gamesradar.com/the-roots-of-open-world-games/>>.

"Soundtrack for Ancient Heroes." *TA NEA Newspaper*. 3 May 2015: n. pag.

"STAR WARS: The Old Republic - Why can't we have Music Play at All Times?" N.p., 2005. Web. 17 Dec. 2016.

<<http://www.swtor.com/community/showthread.php?t=821862>>.

Steadman, Ian. "Brian Eno on Music that Thinks for Itself." *Wired*. N.p., 2016. Web. 17 Dec.

2016. <<http://www.wired.co.uk/news/archive/2012-09/28/brian-eno-peter-chilvers-scape>>.

"Steam Workshop: Authentic Ancient World: Roma Surrectum II Music Pack (And More) - Part I Of IV." *Steam*. Web. 17 Dec. 2016.

<<https://steamcommunity.com/sharedfiles/filedetails/?id=294417870>>.

Stellenbosch, Brink van der Merwe, and Walter Schulze. "Music Generation with Markov Models." *IEEE MultiMedia* 3 (2010): 78-85. Web. 17 Dec. 2016.

<<https://www.computer.org/csdl/mags/mu/2011/03/mmu2011030078-abs.html>>.

Strickland, Erdward. "Riley, Terry." *Grove Music Online. Oxford Music Online*. Web. 9 Aug.

2017. <<http://0-www.oxfordmusiconline.com.wam.city.ac.uk/subscriber/article/grove/music/23474>>.

Stuart, Keith. "Modern Warfare 3 Smashes Entertainment Launch Records." *The*

*Guardian* 2011. Web. 17 Dec. 2016.

<<http://www.guardian.co.uk/technology/gamesblog/2011/nov/11/modern-warfare-3-breaks-sales-records?newsfeed=true>>.

Sweet, Michael. *Writing Interactive Music for Video Games*. Boston, Addison- Wesley, 2015.

"The 15 Best Videogame Soundtracks of 2015." *Paste Magazine*. N.p., 2015. Web. 17 Dec. 2016. <<https://www.pastemagazine.com/articles/2015/12/the-15-best-videogame-soundtracks-of-2015.html?a=1>>.

"The Legend of Zelda: Ocarina Of Time 3D." *Iwata Asks - Nintendo.com*. Web. 10 Aug. 2017. <<http://iwataasks.nintendo.com/interviews/#/3ds/zelda-ocarina-of-time/4/6>>.

Thompson, Matthew. "Analysis: Repetitive Game Music Via Super Mario Bros." *Videogamemusicnerd.blogspot.co.uk*. N.p., 2017. Web. 9 Aug. 2017. <<http://videogamemusicnerd.blogspot.co.uk/2012/08/on-repetitive-nature-of-video-game-music.html>>.

"Title - Times of Lore - Videogame Music Preservation Foundation." *VGMPF*. Web. 17 Dec. 2016. <[http://www.vgmpf.com/Wiki/index.php?title=Title\\_-\\_Times\\_of\\_Lore](http://www.vgmpf.com/Wiki/index.php?title=Title_-_Times_of_Lore)>.

"Times of Lore." *Pix's Origin Adventures*. N.p., 2012. Web. 19 Aug. 2017. <<http://www.pixsoriginadventures.co.uk/category/times-of-lore/>>.

"*Todd Armstrong in Jason And The Argonauts (1963)*." *IMDb*. N.p., Web. 9 Aug. 2017. <<http://www.imdb.com/title/tt0057197/mediaviewer/rm749869312>>.

"Tomb Raider - Legend." *Emuparadise*. Web. 19 Aug. 2017 . <[https://www.emuparadise.me/PSP\\_ISO/Tomb\\_Raider\\_-\\_Legend\\_\(Europe\)/156294](https://www.emuparadise.me/PSP_ISO/Tomb_Raider_-_Legend_(Europe)/156294)>.

"Top 10 Indie Video Game Soundtracks Of 2015" *Indie Game Reviewer*. N.p., 2016. Web. 17 Dec. 2016 . <<http://indiegamereviewer.com/top-10-indie-game-soundtracks-of-2015/>>.

"User-Submitted Name Atreus." *Behind the Name*. N.p., 2013. Web. 9 Aug. 2017.

<<https://www.behindthename.com/name/atreus/submitted>>.

West, M. L. *Ancient Greek Music*. Oxford: Clarendon Press, 1992.

Wilks, Daniel. "The Myth of Non-Linearity." *Metro Magazine: Media & Education Magazine* 144 (2005): 124-127.

Wooller, Rene, et al. "A framework for comparison of process in algorithmic music systems." *Generative Arts Practice, Sydney, Creativity and Cognition Studios Press* (2005): 109-124.

"Wwise Video Tutorials." *Audiokinetic*. Web. 10 Aug. 2017.

<<https://www.audiokinetic.com/resources/videos/>>.

Yee, Nick. "MMORPG Demographics." *PRESENCE: Teleoperators and Virtual Environments* 15.15 (2006): 309-329. Web. 17 Dec. 2016.

<<http://www.nickyee.com/pubs/Yee%20-%20MMORPG%20Demographics%202006.pdf>>.

Yee, Nick. "The DAEDALUS PROJECT: MMORPG Research, Cyberculture, MMORPG Psychology." N.p., 2009. Web. 17 Dec. 2016. <<http://www.nickyee.com/daedalus/>>.

Zorn, John. "COBRA." *Audio Communication Group*. Web. 9 Aug. 2017.

<[https://www2.ak.tu-berlin.de/~gastprof/collins/experimental-music/Zorn/cobra\\_sheet.pdf](https://www2.ak.tu-berlin.de/~gastprof/collins/experimental-music/Zorn/cobra_sheet.pdf)>.