



City Research Online

## City, University of London Institutional Repository

---

**Citation:** Yan, D., Tang, Q., Kovacevic, A., Zhang, Y., Liu, W., Liang, P. & Zhang, H. (2020). Designing nano-aluminum laden fuel pump for aviation applications. Proceedings of the Institution of Mechanical Engineers, Part E: Journal of Process Mechanical Engineering, 234(6), pp. 634-643. doi: 10.1177/0954408920935315

This is the accepted version of the paper.

This version of the publication may differ from the final published version.

---

**Permanent repository link:** <https://openaccess.city.ac.uk/id/eprint/24701/>

**Link to published version:** <https://doi.org/10.1177/0954408920935315>

**Copyright:** City Research Online aims to make research outputs of City, University of London available to a wider audience. Copyright and Moral Rights remain with the author(s) and/or copyright holders. URLs from City Research Online may be freely distributed and linked to.

**Reuse:** Copies of full items can be used for personal research or study, educational, or not-for-profit purposes without prior permission or charge. Provided that the authors, title and full bibliographic details are credited, a hyperlink and/or URL is given for the original metadata page and the content is not changed in any way.

---

City Research Online:

<http://openaccess.city.ac.uk/>

[publications@city.ac.uk](mailto:publications@city.ac.uk)

---

# Designing Nano-Aluminum Laden Fuel Pump for Aviation Applications

Di Yan <sup>1\*</sup>, Qian Tang <sup>2</sup>, Ahmed Kovacevic <sup>3</sup>, Yuanxun Zhang <sup>4</sup>, Wei Liu <sup>2</sup>, Pinghua Liang <sup>2</sup>, Huijun Zhang <sup>5</sup>

<sup>1</sup> School of Machinery and Automation, Wuhan University of Science and Technology, Wuhan, Hubei Province, 430080, P. R. China; dyan@wust.edu.cn

<sup>2</sup> State Key Laboratory of Mechanical Transmission, Chongqing University, Chongqing, 400044, P. R. China; tqcqu@cqu.edu.cn; cquliuwe@cqu.edu.cn; liangpinghua@cqu.edu.cn

<sup>3</sup> Centre for Compressor Technology, City University of London, London EC1V0HB, UK; a.kovacevic@city.ac.uk

<sup>4</sup> College of Aerospace Engineering, Chongqing University, Chongqing, 400044, P. R. China; yuanxun.zh@cqu.edu.cn

<sup>5</sup> Helnco Fluid Power (Beijing) Co., Ltd., 301800, P. R. China; f.zhang@helnco.com.cn

\* Correspondence: dyan@wust.edu.cn

Received: date; Accepted: date; Published: date

**Abstract:** In view of the fact that traditional liquid propellants cannot meet the design requirements of large-thrust flight vehicle, it has become a new trend to add nano metal powder to liquid propellants to greatly increase density and specific impulse. In order to achieve the variable flow-rate and variable-proportion transportation of aviation fuel with nano-aluminum powder, a new type of solid-liquid mixing pumping system is designed, including powder conveying device, stirring device, pump and corresponding drive and transmission system. For the purpose of avoiding the frictional contact between the rotors, which will bring potential hazard to nano-aluminum powder, a non-contact twin-screw pump with synchronous gears is designed. Among them, based on the considerations of flow pulsation, volumetric efficiency and manufacturing difficulty, cycloid profile is adopted for screw rotors. After completing the functional design, geometric parameter design, structural design, 3D modeling, prototype manufacturing and preliminary performance estimation of the mixing pumping system, the performance of the screw feeder, agitator, screw pump was tested through experiments to meet the expected design requirements. It facilitates the rapid real-time preparation of metallized propellants and provides a reference for further improving the design and control methods of nanoparticle two-phase flow pumping.

**Keywords:** screw pump; nano-aluminum powder; fluid-solid flow; aviation fuel; rotor profile

---

## 1. Introduction

With the further advancement of the deep space exploration, research on propellant with high specific impulse has become urgent. Numerous studies have shown that the addition of high calorific value light metal powders such as aluminum powder to liquid propellants can significantly improve the energy performance of propellants, thereby increasing the payload of rockets and missiles [1-4]. In the mid-1980s, NASA began researching metallized RP-1 rocket kerosene. Adding 55% aluminum powder to RP-1 kerosene, the density can be increased from 773 to 1281kg/m<sup>3</sup>. When the payload is 2.25×10<sup>4</sup> kg, the volume of the tank can be reduced from 351.1 m<sup>3</sup> to 304.7 m<sup>3</sup> [5, 6] using RP-1 rocket kerosene with aluminum powder added. When the content of aluminum powder in liquid hydrogen is 60% (liquid oxygen as oxidant), the specific impulse is increased by 49~58.8m/s, and the payload can be increased by 20%~30%[6].

In recent years, the development of nanotechnology has provided a new opportunity for the research of metallized liquid fuels. Compared with traditional micro-aluminum fuels, nano-

aluminum has a special small size effect and surface effect, which makes it more reactive and energy-releasing, and at the same time, it can effectively reduce or even eliminate its sedimentation in liquid fuel. Therefore, nano-aluminum powder can significantly improve the specific impulse, density, safety and other performance of liquid propellant, and has the advantages of both solid and liquid propellants. It is an important development direction of new propellants for aircraft in the future[7, 8].

However, high-efficiency precision pumping and dispersion technology of liquid fuel containing nano-aluminum powder has been a bottleneck problem for the substantive application of this kind of propellant. Nano-aluminum has a large surface and is easily to be agglomerated. Its dispersion level can directly influence the combustion stability of fuel. If the nano-aluminum is dispersed in the energetic material in an uneven state, an unstable combustion phenomenon is bound to occur at the time of combustion. This not only does not improve the energy performance of energetic materials, and has serious safety hazards [9]. At the same time, the controllable thrust is an inevitable trend in the future development of rocket engines. The thrust control of rocket engines is mainly achieved by controlling the flow rate of liquid propellant and the concentration of metal powder in liquid propellant. The traditional solid-liquid mixture fuel is mostly mixed on the ground and then injected into the spacecraft. Although this preparation method is easy to operate, there are drawbacks and hidden dangers of the settlement of the filler over time, and the mixing ratio of solid-liquid fuel cannot be changed in real time, the mobility and flexibility requirements of the task cannot be satisfied. Therefore, in order to prepare and apply the nano-aluminum powder in liquid propellant with excellent performance, the key technologies to be solved are: (1) high-efficiency variable concentration mixing and precise pumping technology of nano-aluminum powder and liquid fuel; (2) nano- dispersion technology of aluminum powder in liquid fuels.

Traditional single-phase liquid fuels are usually transported by gear pumps, gerotor pumps or rotary vane pumps, which have some structural and functional deficiencies for transporting particle-laden flow. Firstly, non-contact operation is not possible for these pumps, and friction between gears or rotors may cause changes in the properties of nano-aluminum powder, there is also a potential danger of explosion due to frictional heat. Secondly, due to the structural characteristics of these pumps, there is a large pulsation and does not have the function of mixing during conveying the medium. In contrast, screw pump has the advantages of simple and compact structure, small pulsation, energy saving and high reliability, plus its superior multiphase conveying performance, has been widely used in aerospace, offshore platforms and petrochemical industry.

By arranging a pair of synchronizing gears at the rotor shaft end, the screw pump can perform a wide range (0~300 $\mu$ m) clearance design, thereby achieving non-contact operation between two rotors and the casing, and avoiding friction and wear of rotors. And the danger of frictional heating of the fluid medium can also be eliminated. Moreover, due to its unique spiral chamber, screw pump has the function of mixing and agitating the transport medium during operation. Therefore, by comparing the performance and characteristics of various positive displacement pumps such as piston pump, gear pump, gerotor pump and vane pump, screw pump has unique structural and functional advantages when mixing and transporting the nanoparticle-laden energetic fuel.

This paper systematically introduces a new design of solid-liquid two-phase mixed transport system, including powder conveying mechanism, stirring mechanism, screw pump, drive and transmission system, etc. After the prototype manufacturing and performance testing, the performance of each individual function module are obtained, as well as the overall performance of the system when conveying nano-aluminum and aviation kerosene with variable volume flow rate and variable mixing ratio. The research will enable the reliable and accurate pumping of high-performance liquid propellants containing nano metal particles, providing a technical reference for the rapid real-time preparation of metallized propellants. At the same time, it is helpful to establish and improve the theory and control method of nanoparticle two-phase variable-concentration pumping, and to promote the large-scale industrial application of nanofluids.

## 2. System Design

The liquid fuel in solid-liquid mixed transportation is aviation kerosene, and the solid fuel is nano-aluminum powder. In order to meet the fuel delivery requirements of a specific aircraft, the pumping system in the mixing process should meet the following conditions:

1. The inlet pressure is 70kPa-270kPa (absolute pressure);
2. The outlet pressure is no higher than 800kPa;
3. The flow rate of the solid-liquid mixed fuel transportation should be within 30-600L/h;
4. The volume ratio of solid powder mixed in liquid fuel can reach 10% - 35% and be variable;
5. The volume size of the system is within 300mm\*300mm\*450mm, and the total weight is no heavier than 20kg;
6. Each continuous working time is no shorter than 2.5h, the accumulated working life is no shorter than 10h, and the total storage life is no shorter than 33 years.

According to the functional division system, in order to meet the requirements of solid-liquid mixing and variable transportation, it is recommended to divide the design requirements into three functional modules. First, variable transportation of the solid powder is achieved, and secondly, variable transportation of the liquid fuel is achieved. Third, achieve uniform mixing. The solid-liquid ratio change can be achieved by controlling the amount of powder delivered. By controlling the amount of liquid fuel delivered, the total flow rate can be varied; by adjusting the structure of the mixing chamber, mixing uniformity can be achieved. The functional module design of the entire device is shown in the Figure 1.

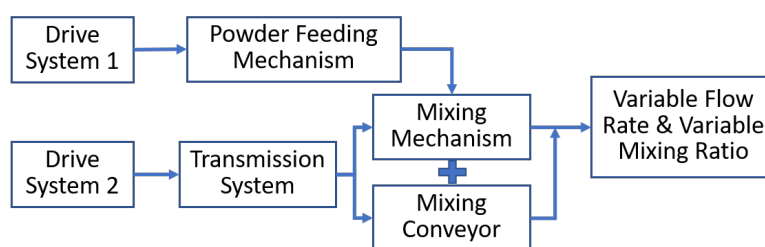

**Figure 1.** Function design of the pumping system

In engineering applications, conveyor machinery dedicated to moving solid and bulk materials including belt conveyors, screw conveyors, scraper conveyors, bucket elevators, vibration and pneumatic conveyors, roller conveyors, etc. By comparative analysis of various solid powder conveying devices, in view of that the solid powder particles applied in this design are particularly small, and at the same time, variable transport is required, considering the size of the transport medium particles, the sealing and stability of the conveying device, it is proposed to use a screw feeder as the powder conveying equipment in the system.

The variable delivery of liquid fuel usually uses positive displacement pumps which have high volumetric efficiency. Compared with gear pumps, vane pumps, gerotor pumps and reciprocating pumps, the twin-screw pump has small hydraulic pulsation and can adapt to a wide range of viscosity. The flow rate will not decrease with the increase of the viscosity of the liquid, and the cavitation phenomenon in screw pump is not obvious which can be neglected, it is especially applicable to the medium with variable viscosity caused by the changing of the mixing ratio of fluid-solid fuel. Twin-screw pump has small friction loss at the meshing area. Compared with plunger pump and gear pump, screw pump has no trapping phenomenon, therefore, it has stable operation, low vibration, low noise and long working life. According to the particle size of the mixed powder in pump, rotor profile can be modified in a certain amount, and by installing synchronous gears, the meshing safety can be ensured, and the rotor friction and the rubbing of the metal powder during the meshing process can be avoided.

According to the overall design requirements and research analysis, the following four design schemes are proposed:

- **Scheme 1: Direct delivery of mixed fuel**

Since the solids and liquids to be mixed are fuels, not fuels plus oxidants, if they can be mixed in advance and then transported, the entire conveying device is the same as the device for conveying pure liquid fuel, and the structure and function will be very simple and highly reliable. However, since the metal powder is insoluble in the liquid fuel, the mixed fuel has the drawback of precipitating over time, it is difficult to store for a long time while maintaining a uniform mixing state. Meanwhile, this design scheme cannot realize the mixed transport of the variable concentration.

- **Scheme 2: Conveying while mixing in screw pump**

As mentioned above, after comprehensive comparison of various solid power conveying equipment, screw feeder is most suitable to transport solid powder fuel, it can achieve forced quantitative transport, while solving the problem of easy agglomeration of powdered fuel. According to the application in pharmaceutical engineering, it is found that the screw feeder is suitable for the transportation of materials that need to be sealed and transported, such as powder, granules and small pieces, and also for the transportation of viscous and easy-to-agglomerate materials. The overall mixed transport design is shown in Figure 2.

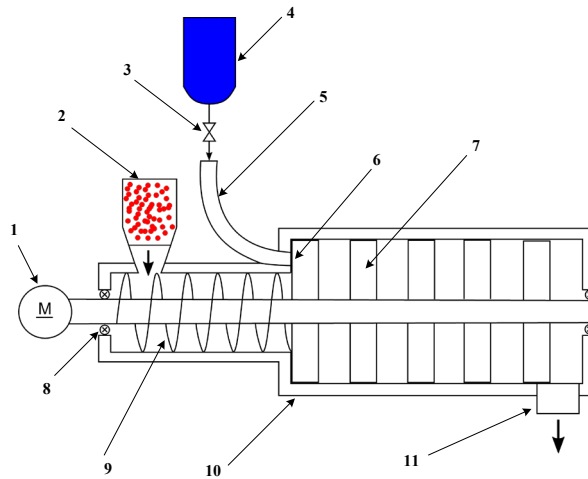

**Figure 2.** Schematic diagram of conveying while mixing in screw pump. 1 - motor, 2 - solid fuel tank, 3 - valve, 4 - liquid fuel tank, 5 - liquid fuel inlet pipe, 6 - inlet port for liquid fuel, 7 - screw pump, 8 - bearing, 9 - screw feeder, 10 - housing, 11 - mixed fuel outlet port

Among them, the screw feeder and the driving rotor of screw pump are directly connected, and the two rotation speeds are the same, which can realize the synchronous increase and decrease of the flow rate.

- **Scheme 3: mixing in screw feeder before conveying in screw pump**

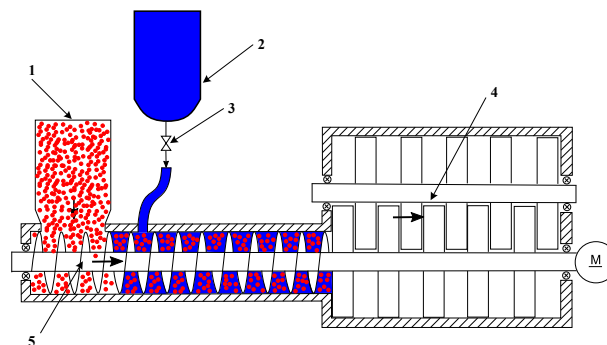

**Figure 3.** Schematic diagram of mixing in screw feeder before conveying in screw pump. 1 - solid fuel tank, 2 - pressurized liquid fuel tank, 3 - flow control valve, 4 - screw pump, 5 - screw feeder

This scheme is firstly to input the liquid and solid fuel into the screw feeder at the same time, complete mixing, and then transport through the screw pump. Among them, by controlling the flow control valve for liquid fuel injection, the solid-liquid mixing ratio can be controlled. Compared with Scheme 2, the liquid fuel and the solid powder fuel are mixed before transported into screw pump, the uniformed mixing of discharged fuel could be more easily ensured.

- **Scheme 4: Dilute first before conveying**

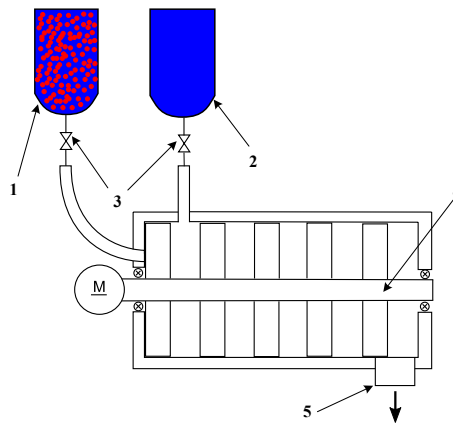

**Figure 4.** Schematic diagram of diluting first before conveying. 1 - pressurized solid-liquid mixed fuel tank, 2 - pressurized liquid fuel tank, 3 - flow control valve, 4 - screw pump, 5 - outlet port

Since liquids are easier to achieve accurate and efficient variable transport than solid powders, a scheme is proposed that solid-liquid mixed fuel with a higher concentration is firstly injected of and then pure liquid fuel is added to dilute (as shown in Figure 4). Thus, variable concentration and variable flow rate for mixed fuel can be realized. Considering the solid-liquid mixing ratio varies from 10% to 35%, Component 1 in Figure 4 is a pressurized mixed fuel tank in which the solid-liquid mixing ratio is 35%. Component 2 is a pressurized tank with pure liquid fuel, and the mixed fuel in 1 is diluted by controlling the amount of pure liquid fuel input using the flow control valve, and uniformly mixed in the screw pump.

Compared with Scheme 2 and Scheme 3, the advantage of Scheme 4 is that it avoids the difficulty of achieving accurate variable transport of powder fuel. The screw feeders in Scheme 2 and 3 are eliminated, and the structure is simpler and more reliable, and all are liquid transported. This scheme can bring accurate control of flow rate and mixing ratio, and have high delivery efficiency. The shortcoming of this scheme is that the mixed fuel with high concentration is prone to sediment. In order to ensure sufficient mixing and avoid clogging during transportation, it is necessary to add a stirring impeller inside the high-concentration mixed fuel tank, and continue to stir to maintain evenly mixed state.

After comprehensive comparison, Scheme 2 and 3 are more in line with the design requirements, but in these two schemes, the screw feeder and the screw pump are directly connected, the rotation speed is consistent, the flow rate and the concentration are positively correlated, and the flow and concentration cannot be controlled independently. Therefore, the screw feeder and the screw pump require separate drive systems. At the same time, although screw pump itself has the function of stirring and mixing during the conveying process, in order to ensure the sufficient mixing of the solid-liquid fuel, it is necessary to add an agitator before the screw pump to complete the mixing of metal powder and liquid fuel. Before the whole system starts working, the liquid fuel is firstly filled into the mixing chamber of the agitator, and then the solid powder is fed in, after full mixing completed, the screw pump of next stage starts to work. In addition, in the position where the powder is in contact with the liquid, it is necessary to consider setting a backflow prevention measure to prevent the liquid fuel from flowing into the screw feeder or even into the powder box.

According to the discussion above, the three functional modules of the whole system respectively correspond to the screw feeder, the agitator, and the twin screw pump, and the three are connected in

series. In view of that there are two control variables, the variable mixing concentration and variable volume flow rate, two independent controllers are required. The screw feeder is separately controlled. The agitator and the twin screw pump are connected through the transmission system and controlled by another separate control system, which also ensures sufficient mixing under large discharge volume flow rate. Two separate control systems are independently controlled by the respective drive system.

### 3. Components Design

#### 3.1. Design of Powder Conveyor

Screw feeder is a traditional and effective machine for powder conveying, it is adopted for the variable conveying of aluminum powder in this design. The accuracy and efficiency of powder delivery depend on the state of the powder entering the delivery chamber, the structure of the screw blade, the geometry of chamber, and the rotational speed[10]. Among them, due to the different structures of the powder storage box, the flow model of the powder entering the screw conveyor under the action of gravity mainly has the following patterns, as shown in Figure 5.

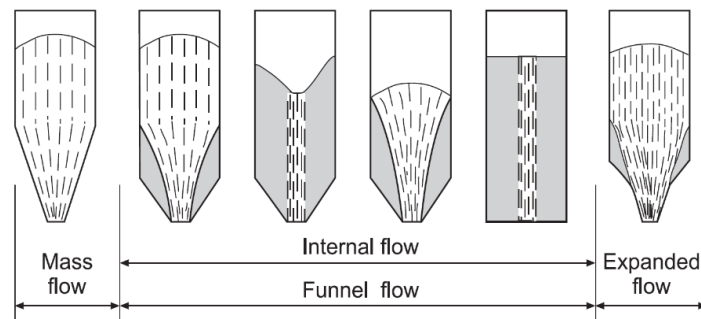

Figure 5. Flow patterns from a powder tank[10]

Different flow patterns directly determine the initial flow rate of the powder entering the screw feeder, thereby affecting the conveying efficiency of the screw feeder. According to the flow patterns and the physical properties of the powder, the structure of the powder storage box can be optimized to reach higher conveying efficiency while avoiding clogging during the downward flow of the powder.

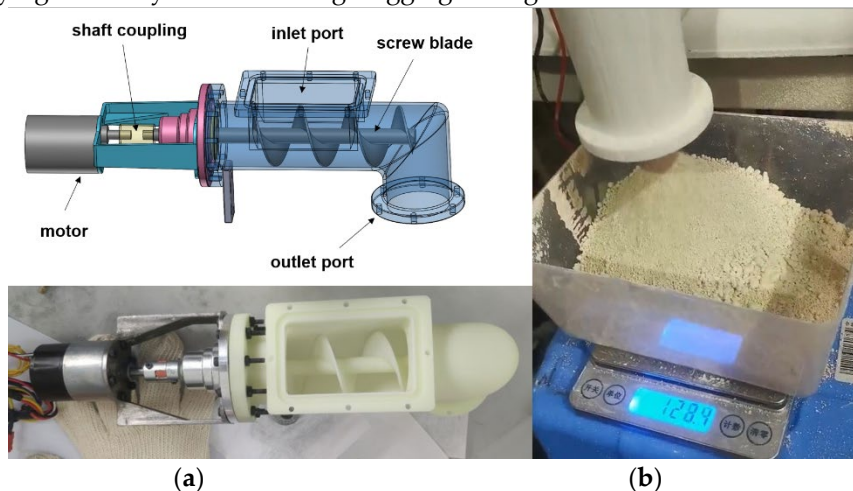

Figure 6. Screw feeder design (a) 3D model and prototype, (b) performance testing and calibration

The structure of the screw feeder is simple, and the solid powder in the closed chamber is pushed towards axial direction through a spiral rotor. In a certain range of speeds, namely when the powder can completely fill the chamber during transport, the amount of powder delivered is proportional to the rotational speed. This linear relationship is related to the physical properties of the powder and the design of the rotor. A digital weighing device is placed at the exit of the screw feeder, and the powder conveying capacity of the screw feeder at different rotation speeds is determined by the



powder feeding test, shown as Figure 6 (b). When converting weight to volume and using a numerical fit, the characteristic curve of the screw feeder can be obtained, shown in Figure 7, test results are based on 50nm nano-aluminum powder. Due to the good fluidity of the nano-aluminum powder, the conveying process of screw feeder is smooth and stable, and meets the design requirements.

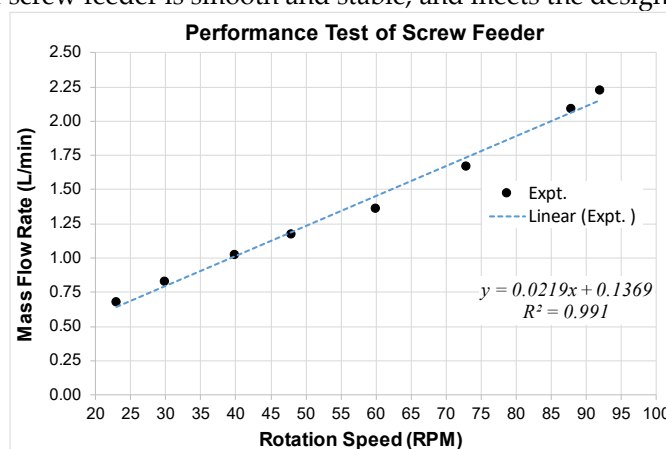















Figure 7. Fitting of experimental performance of screw feeder based on nano-aluminum powder

### 3.2. Design of Agitator

The design of the agitator directly determines the mixing state of the nano-aluminum powder in the liquid fuel. At a certain speed, the impeller design in the agitator directly determines the mixing effect and efficiency.

In order to ensure the uniformity of mixing, 13 different types of impellers (as shown in Table 1) have been designed[11], the mixing effect and efficiency of different impellers are compared and analyzed through experimental observation.

Table 1. different impeller types and their structures

Number	1	2	3	4	5	6	7
Impeller Type	Propeller-type impeller	Propeller-type impeller	Propeller-type impeller	Paddle-type impeller	Paddle-type impeller	turbine-type impeller	turbine-type impeller
Parameter (lobes/angle)	3 /45°	3/20°	3/60°	2/45°	2/60°	4/0°	4/45°
Typical Structure							
Number	8	9	10	11	12	13	
Impeller Type	Rushton turbine	Pitched-blade turbine	Sawtooth-type impeller	Anchor-type impeller	Ribbon-type impeller	Reverse pitch impeller	
Parameter (lobes/angle)	5/0°	5/45°	18	2/0°	2	2/±45°	
Typical Structure							

The experimental observation device is shown in Figure 8 (a), using iron oxide powder as the solid powder for mixing. When the agitation tank is filled with liquid, after adding iron oxide powder to one end, the colored powder continuously spreads to the right end until it is uniformly mixed. At the same rotational speed, a fixed amount of solid powder was added for each type of impeller, and the mixing process was recorded while recording the mixing time. The images are captured at fixed

time intervals in the video file, and the images are compared and analyzed to obtain the mixing effect and mixing efficiency of different impellers.

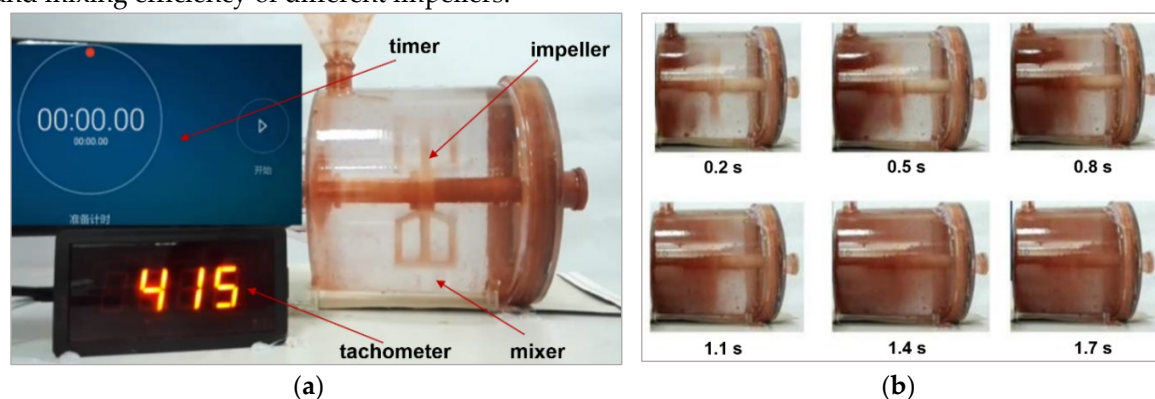

Figure 8. (a) Mixing effect test device; (b) mixing effect at different times

Table 2 shows the surface areas corresponding to the 13 impeller types, and the time required for the iron oxide powder in the agitator to reach sufficient mixing at 400 rpm and 500 rpm, respectively. It can be seen that in the case where the impeller area is close, the mixing effect of the impeller 1, 7, 11 and 13 are better, and the homogenization mixing can be quickly achieved.

In order to select the best impeller among these four impellers, the mixing process of the four impellers in 1.7s was compared and analyzed (as shown in Figure 8 (b)). It was found that the No. 1 propeller-type impeller can achieve maximum mixing in a short period of time.

Table 2. Comparison of the mixing process of different impeller types

Number	1	2	3	4	5	6	7	8	9	10	11	12	13
Impeller Area(mm <sup>2</sup> )	648	645	645	648	648	636	627	631	635	632	645	674	630
Time (s) (400rpm)	12.5	>20	14	13.5	12	10.4	13.5	16.8	14.5	18.5	10	>20	16
Time (s) (500rpm)	7.5	>20	10.5	9.5	11	6.8	7.5	12	11.5	12.5	7.5	>20	8.5

### 3.3. Design of Transmission System

There are two motors in the conveying system while there are three main shafts that require power input. The rotation speeds of the screw feeder and the male rotor of screw pump are controlled separately, and the spindle in the agitator is indirectly connected to the screw rotor through the transmission system. Common mechanical transmissions include chain drive, belt drive, and gear transmission. Among them, the chain drive is suitable for long-distance transmission, since the links in chain drive are rigid, there is a polygon effect caused by motion non-uniformity that changes the instantaneous gear ratio of the chain drive and causes additional dynamic loads and vibrations. Due to the possibility of elastic sliding, the belt drive cannot guarantee an accurate transmission ratio, and the transmission efficiency is relatively low, which is about 90%-94%. The service life of the belt is short, and it is not suitable for use in high temperature, flammable, corrosive and oily occasions. The gear transmission has high transmission efficiency, high stability and reliability, which meets the design requirements of the device, so the gear transmission system is adopted.

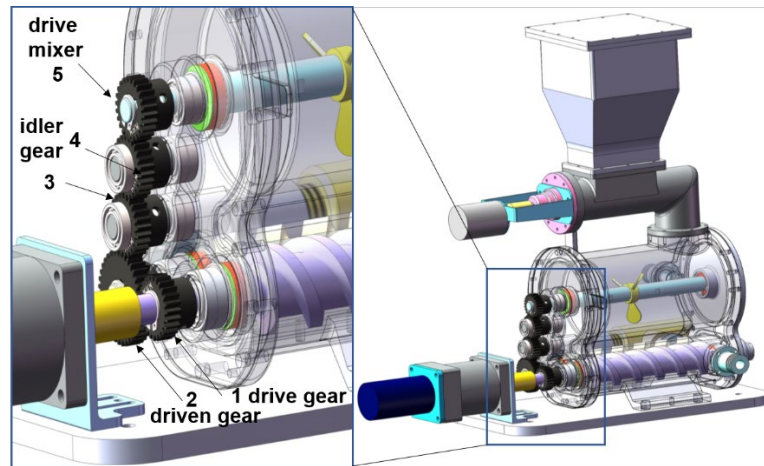

Figure 9. Gear system design in the device

Through the gear transmission, the rotation speed of the agitator is synchronously matched with the screw rotor. When the rotation speed of screw pump is increased and the flow rate is increased, the rotation speed of the agitator is also increased accordingly, thereby ensuring sufficient mixing before the output of the screw pump. The gear system is shown in Figure 9. According to the arrangement of the structural size and the spatial position, two identical idlers are arranged between the driven screw rotor and the main shaft of the agitator. Refer to the standard involute cylindrical gear, the main parameters of each gear in the transmission system are shown in Table 3.

Table 3. Gear parameters in the transmission system

Gear	1	2	3	4	5
Modules	1	1	1	1	1
Number of teeth	24	36	24	24	24
Tooth width (mm)	12	10	10	10	10

### 3.4. Design of Screw Pump

Firstly, according to the volume flow rate requirement and the range of the motor speed, the diameter of the screw rotor can be estimated. From the viewpoint of weight reduction, the screw rotor diameter should be designed as small as possible, but at the same time, the processing difficulty, the sealing, and bearing design under small rotor diameter conditions need to be considered as well, and a certain volumetric efficiency also needs to be guaranteed[12].

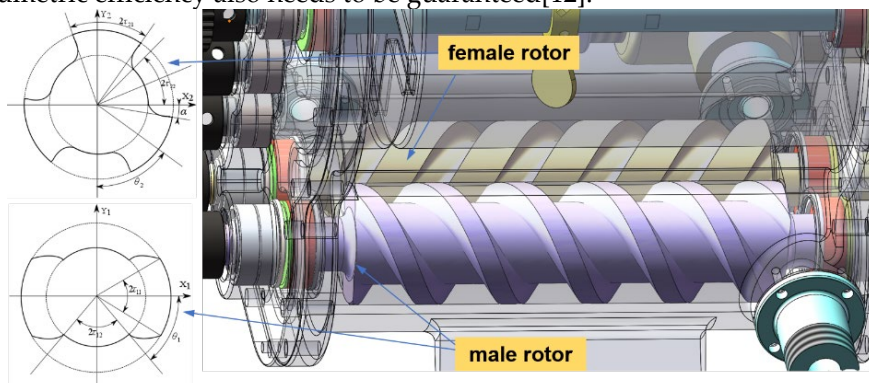

Figure 10. Generation of cycloid rotor profile

Figure 10 shows the generation of cycloid rotor profile which is mainly composed of cycloidal arc and circular arc[13].

Male Rotor

Cycloid Curve:

$$\begin{bmatrix} x_{11} \\ y_{11} \\ 1 \end{bmatrix} = \begin{bmatrix} \cos t & -\cos(1 + i_{21})t & 0 \\ \sin t & -\sin(1 + i_{21})t & 0 \\ 0 & 0 & 1 \end{bmatrix} \begin{bmatrix} a \\ R_t \\ 1 \end{bmatrix} \tag{1}$$

Female Rotor  
Epicycloid:

$$\begin{bmatrix} x_{21} \\ y_{21} \\ 1 \end{bmatrix} = \begin{bmatrix} \cos t & -\cos(1 + i_{12})t & 0 \\ \sin t & -\sin(1 + i_{12})t & 0 \\ 0 & 0 & 1 \end{bmatrix} \begin{bmatrix} a \\ R_t \\ 1 \end{bmatrix} \tag{2}$$

Straight line modification:  
The length of the straight line

$$L = 0.05R_t \tag{3}$$

By solving the following equation

$$x_2^2 + y_2^2 = (R_t - 0.05R_t)^2 \tag{4}$$

Then the coordinates of the intersection point ( $m, n$ ) can be obtained.

The angle between the radial straight line and the x-axis is

$$\alpha = \arctan\left(\frac{n}{m}\right) \tag{5}$$

The equation of the straight line is as follows:

$$\begin{cases} x_{22} = R_t \cos t \cos \alpha \\ y_{22} = R_t \cos t \sin \alpha \end{cases} \tag{6}$$

The envelope line of the straight-line modification in male rotor can be expressed as

$$\begin{cases} x_{12} = a \cos t - R_t u \cos(1 + i_{21})t \\ y_{12} = a \sin t - R_t u \sin(1 + i_{21})t \\ \frac{\partial x_{12}}{\partial u} \cdot \frac{\partial y_{12}}{\partial t} - \frac{\partial x_{12}}{\partial t} \cdot \frac{\partial y_{12}}{\partial u} = 0 \end{cases} \tag{7}$$

Whereby,  $u = f$  (8)

( $t$ )

$$\begin{bmatrix} x_{12} \\ y_{12} \\ 1 \end{bmatrix} = \begin{bmatrix} \cos t & -f(t)\cos(1 + i_{21})t & 0 \\ \sin t & -f(t)\sin(1 + i_{21})t & 0 \\ 0 & 0 & 1 \end{bmatrix} \begin{bmatrix} a \\ R_t \\ 1 \end{bmatrix} \tag{9}$$

Then the equation of cycloid curve in male rotor is

$$\begin{bmatrix} x'_{11} \\ y'_{11} \\ 1 \end{bmatrix} = \begin{bmatrix} \cos t & -\cos(1 + i_{21})t & 0 \\ \sin t & -\sin(1 + i_{21})t & 0 \\ 0 & 0 & 1 \end{bmatrix} \begin{bmatrix} a \\ 0.95R_t \\ 1 \end{bmatrix} \tag{10}$$

Where,  $R_t$  is tip circle radius,  $R_r$  is root circle radius,  $r_1$  is pitch circle radius of male rotor and  $r_2$  is pitch circle radius of female rotor.

Transmission ratio

$$i_{12} = \frac{n_1}{n_2} = \frac{\omega_1}{\omega_2} = \frac{r_2}{r_1} \tag{11}$$

$$R_r = \text{Center distance} = R_t + \tag{12}$$

The tip of female rotor and the root of male rotor can also be modified by the round-corner modification method.

The designed geometric parameters of screw pump are displayed in Table 4. Figure 11 shows the finished prototype of the designed screw rotors.

**Table 4.** Geometry parameters of screw rotors used in study

	Lobes	Outer Diameter (mm)	Inter Diameter (mm)	Pitch Diameter (mm)	Lead (mm)	Wrap Angle (°)
Male Rotor	2	35.950	23.950	24.000	50.000	936
Female Rotor	3	35.950	23.950	36.000	75.000	624
Axis distance	30.000mm					
Rotor length	130.000mm					
Radial clearance	0.050mm					
Inter-lobe clearance	0.050mm					

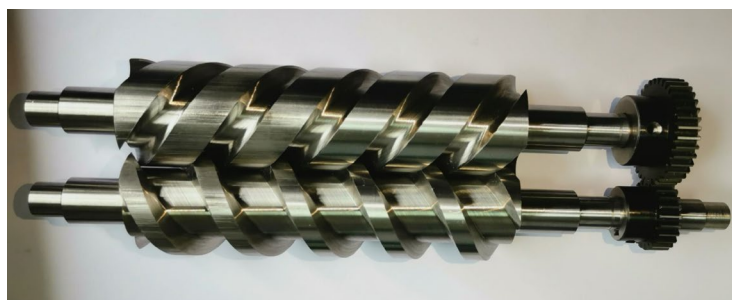

**Figure 11.** Finished product of the designed screw rotors

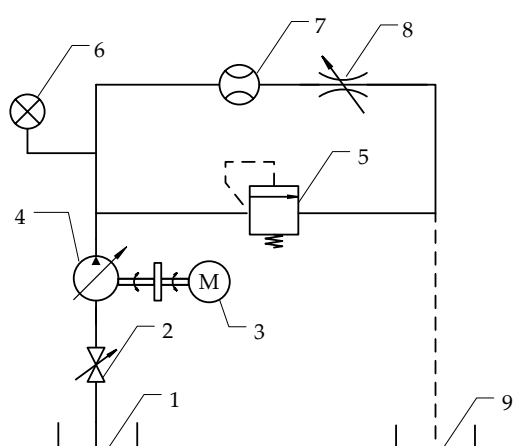

1- liquid fuel tank, 2- gate valve, 3- motor, 4- screw pump, 5- bypass valve, 6- pressure gauge, 7- flowmeter, 8- throttle valve, 9- fuel bin

**Figure 12.** Test rig for screw pump

In order to evaluate the performance of the screw pump, a test rig is built. The test system consists of a hydraulic circuit part and a test circuit part. The two parts are connected by digital components as shown in Figure 12. The conveying medium of the screw pump used in the test is HD-01 aviation kerosene. The volume flow rate is controlled by adjusting the motor speed, and the outlet pressure value is changed by the pressure regulating valve at the outlet. The volume flow rate of the screw pump is set to 4, 6, 8, 10L/min in turn, the outlet pressure under the set volume flow rate is changed by adjusting the pressure regulating valve. When the discharge pressure gradually changes from 0 to 800Kpa, the rotation speed and power value of the screw pump are being recorded, and the volumetric efficiency can be calculated, so the conveying performance of the designed screw pump based on the aviation kerosene is obtained. The performance characteristics obtained in the test are shown in Figure 13.

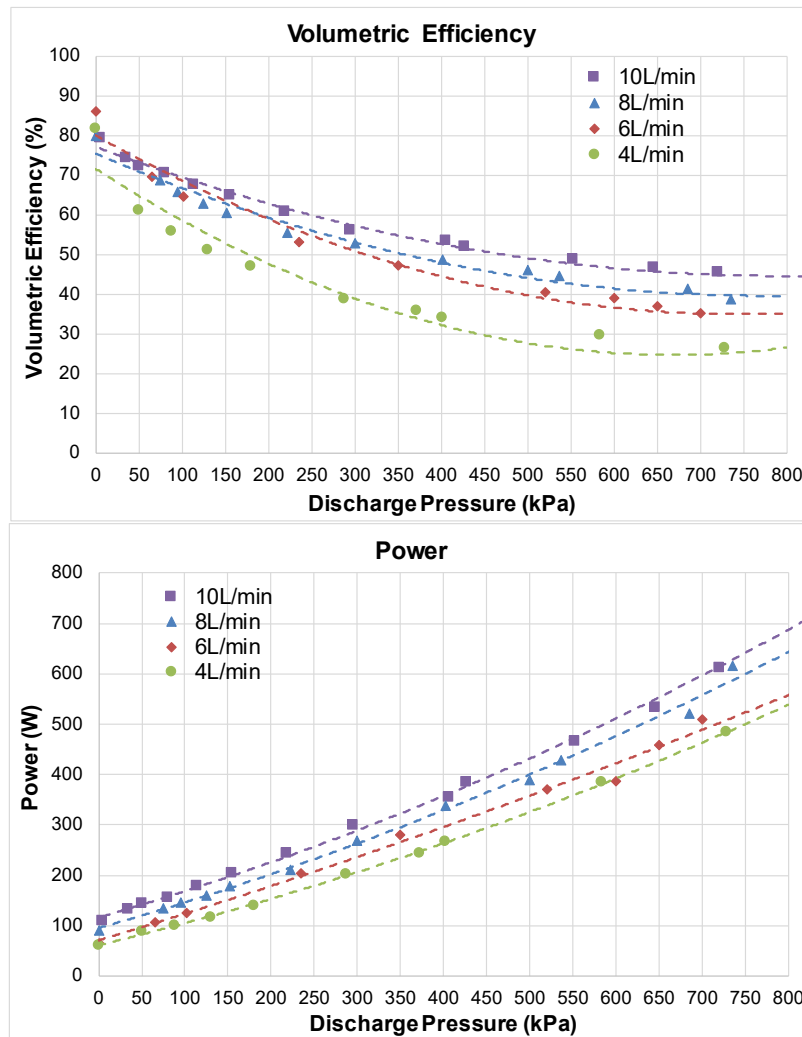

Figure 13. Experimental data of performance of the designed screw pump

From the analysis of the test results shown in Figure 13. It can be concluded that:

- Because the diameter of the screw rotor is small, and the clearances designed to avoid the contact friction of the rotor are also slightly large, the volumetric efficiency of the designed screw pump is lower than that of the conventional industrial screw pump. This also provides a reference for the optimization design of the screw pump.
- Under the same volume flow rate conditions, the outlet pressure of the screw pump changes from 0 to 800kPa. As the outlet pressure increases, the volumetric efficiency of the screw pump gradually decreases. Among them, when the outlet pressure is below 200Kpa, the volumetric efficiency of the screw pump is relatively within acceptable limits;
- According to the change of volume flow rate from 4L/min to 10L/min, it can be observed that the volumetric efficiency of the screw pump increases along with the increase of the volume flow rate, when under the same discharge pressure. Among them, when the flow rate is 10L/min with the discharge pressure of 500kPa, the volumetric efficiency reaches about 50%. If the volume flow rate is further increased, the volumetric efficiency will be further improved.
- In order to further improve the volumetric efficiency of the screw pump, it is considered to appropriately reduce the design clearances without increasing the diameter of the screw rotors, and at the same time determine the appropriate rotation speed range.
- Under constant flow rate conditions, the power of the screw pump increases with increasing outlet pressure; at the same outlet pressure, the power of the screw pump increases with increasing flow rate.

#### 4. System Performance Test



The test work of the mixing pumping equipment is carried out after the completion of the processing, assembly, test bench construction and commissioning of the mixing and conveying device, and is an important work for the actual test of the overall performance of the whole system. Refer to the JB/T 8091-1998 screw pump test method and combine the design requirements of the mixing pumping system to arrange the overall performance test bench[12], so that the test bench can realize the pump performance test under the condition of variable outlet pressure, variable volume flow rate and variable mixing ratio. The test bench uses a fully digital control and reading system. The experimental setup is shown in Figure 14. Figure 14 (a) shows the schematic diagram of the test bench system. A pressure gauge is installed at the outlet of the pump. By controlling the throttle valve, the discharge pressure of the pump is set as 0.8 MPa. The connecting pipes are thickened transparent silicone pipes, and the connection forms are pipe thread connection. A flow meter and a throttle valve are installed in the pipeline. The real-time flow rate and outlet pressure can be measured in this hydraulic system.

Table 5 shows the measurement accuracy of the main test instruments.

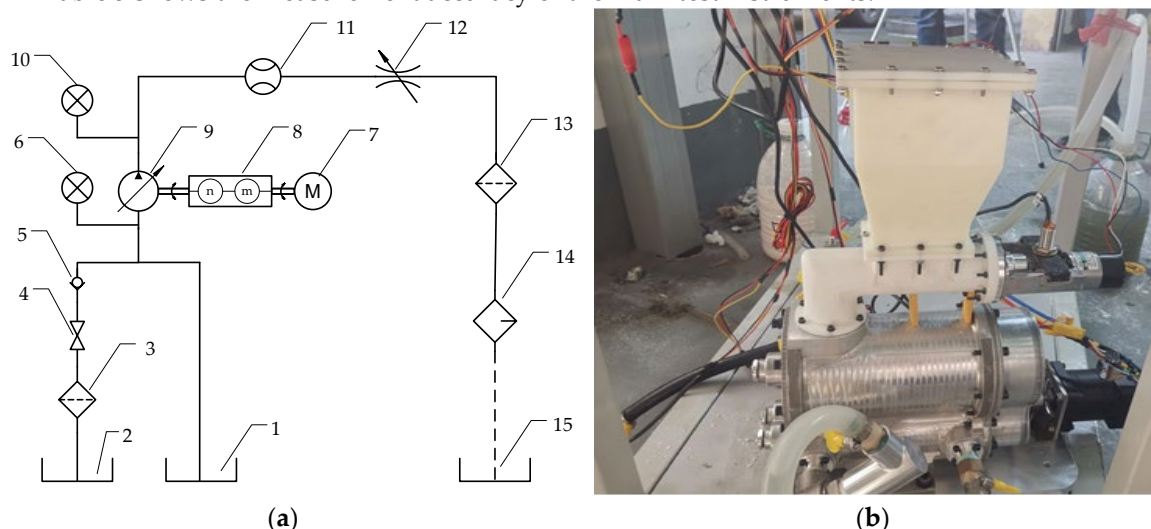

1-powder tank, 2-liquid fuel tank, 3-filter, 4-gate valve, 5-one-way valve, 6-vacuum gauge, 7-motor, 8-torque meter & revolution meter, 9-screw pump, 10-pressure gauge, 11-flow meter, 12-throttle valve, 13-filter, 14-cooler, 15-mixed fuel bin

Figure 14. System performance test bench

Table 5. Accuracy of instrumentation used in performance measurements

Measured value	Instrument used	Accuracy
Speed measurements	Revolution Meter	< ±0.5%
Torque	Torque Meter	< ±1.5%
Pressure	Pressure Gauge	≤ 1.6%
Temperature	Thermometer	< ±1°C
Flow rate	Flow Meter	≤ 0.5%

Since the mixing state of nano-aluminum powder and HD-01 aviation kerosene is still unclear, it is first necessary to test the mutual solubility of these two materials. By extracting certain mixture samples for the mutual solubility test, it can be observed that whether the nano-aluminum powder will precipitate in the aviation kerosene, and how long will it take for the complete precipitation. It will help to design the evaluation index of the mixing uniformity. The experimental results show that the nano-aluminum powder and HD-01 aviation kerosene are not soluble in each other. Under stirring, the nano-aluminum powder can be fully suspended in aviation kerosene. However, due to the presence of gravity, the mixed nano-aluminum powder will precipitate after standing still for several hours.

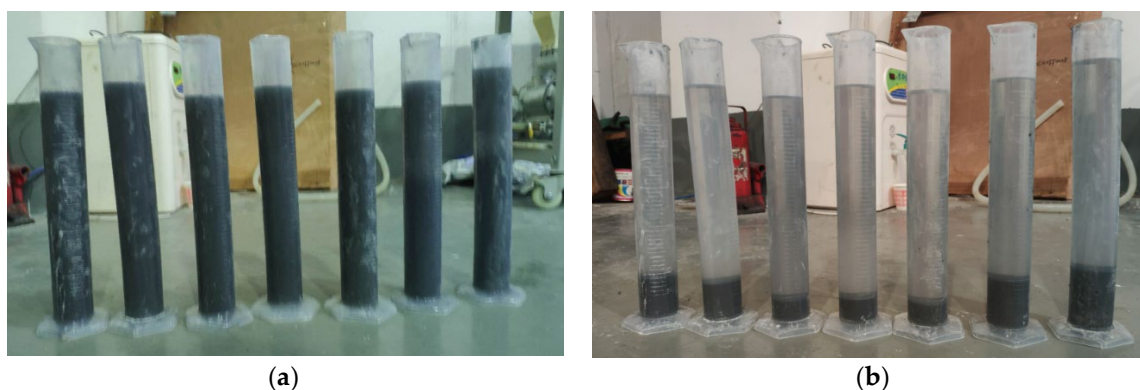

Figure 15. (a) Samples taken at the same time interval; (b) Samples after standing still for 24 hours

In the overall performance test of the system, the required rotation speed of the screw pump and the screw feeder can be calculated by the given mixing ratio and volume flow rate. The actual mixing ratio can be determined by measuring the sedimentation height in the mixed fuel sample after standing still. It can be seen from the comparison of the samples in Figure 15 that although the mixture contains precipitate, their amount in each sample are relatively different. Table 6 shows the sampling of the discharged medium at equal intervals in this condition, wherein the ratio of the sediment height to the total liquid level in the measuring cup can be used to evaluate the mixing ratio of the solid powder in the mixed fuel. It can be seen from the comparison of the 7 samples discharged in sequence that the actual mixing ratio shows significant fluctuations.

Table 6. Sediment in mixture samples

Samples	1	2	3	4	5	6	7
total volume (ml)	250	255	245	250	245	260	265
sediment volume (ml)	45	30	22	22	21	45	52
Sediment height ratio	0.18	0.118	0.09	0.088	0.086	0.173	0.196

**Note:** During the experiment, the mixing ratio of nano-aluminum powder and HD-01 aviation kerosene did not reach the maximum value of 35% in the design requirements, which is due to the fact that the nano-aluminum powder itself has a relatively high price and a large consumption at one time. It is not recyclable.

### 5. Discussion and Conclusions

This paper introduces the whole design process of a new type of solid-liquid mixed pumping system for aviation applications, including system design, structural design, and performance evaluation. In the design process, the mutual matching and structural optimization of each functional module are involved to ensure the accuracy, efficiency, lightweight and low energy consumption of the entire system. Among them, the calculation of power consumption, the design and selection of motors, bearings, seals, etc. are not described in detail due to the length limitation of this paper. After the design and prototype machining were completed, the screw feeder and the screw pump were separately tested for performance, and their respective performance curves were obtained. A comparative study of the impellers of the agitator was carried out, and an impeller capable of achieving rapid and thorough mixing in a short time was selected.

1. Through the prototype test of the whole system, we can know the conclusions as follows:
2. The designed mixing device can realize the mixed conveying of nano-aluminum powder and HD-01 aviation kerosene in function;
3. Through the agitator, the mixing device can ensure the mixing uniformity of the mixed fuel;
4. Through sampling comparison, it is found that the mixing ratio in the conveying process is not stable and needs to be further improved;
5. As described in Section 3.1, after experimental testing, the powder delivery volume of the screw feeder is proportional to the rotation speed, and there is no large flow fluctuation in a



certain speed range. Therefore, there are two main reasons for the fluctuation of the mixing ratio: firstly, during the stirring process, the mixing and distribution of the nano-aluminum powder will change with the rotation speed of the agitator; Secondly, the distribution of nanoparticles in the pump chamber may also change when the rotation speed of the screw pump changes. This is also the next-step work, to carry out the numerical simulation and experimental research on the solid-liquid two-phase flow in the agitator and the screw pump, to obtain the phase distribution characteristics of the particles, and to understand the key factors that cause the fluctuation of the mixing ratio of the mixed pumping system, thereby improving the mixing precision.

As a first-generation prototype, this design meets the requirements for variable-mixing and variable-flow conveying required for operating conditions. In order to further enhance the performance and reliability of the prototype, there is still a lot of work to be done. The first is the lightweight design of the overall structure. As the fuel pumping system for flight vehicle, the lighter weight means lower energy consumption and cost; Secondly, the structure of key components needs to be optimized to improve the conveying accuracy and efficiency of the entire system; Then, reliability is also a key consideration, and the prototype needs to be tested for durability and life, including performance characteristics under extreme conditions, such as large temperature differences and large vibration conditions; Finally, the computational fluid dynamics analysis of the system is needed to establish an accurate numerical model of the solid-liquid mixture flow of the whole system, which can provide theoretical support for the design of the next-generation prototype.

**Author Contributions:** conceptualization and methodology, D.Y. and Y.Z.; validation and experiment, W.L. and P.L.; prototype manufacturing of screw pump, H.Z.; writing—original draft preparation, D.Y.; writing—review and editing, A.K.; project administration, Q.T.

**Funding:** The support of grant number 2017M622531, grant number G51, grant number 2018A07 are acknowledged.

**Acknowledgments:** The authors wish to acknowledge the support provided by State Key Laboratory of Mechanical Transmission in Chongqing University, Beijing Institute of Power Machinery and Helnco Fluid Power (Beijing) Co., Ltd.

**Conflicts of Interest:** The authors declare no conflict of interest.

## References

1. Li, J., I. Rozen, and J. Wang, *Rocket Science at the Nanoscale*. ACS Nano, 2016. **10**(6): p. 5619-34.
2. Mehregan, M. and M. Moghiman, *Effect of aluminum nanoparticles on combustion characteristics and pollutants emission of liquid fuels – A numerical study*. Fuel, 2014. **119**: p. 57-61.
3. Fedlheim, D.L. and C.A. Foss, *Metal nanoparticles: synthesis, characterization, and applications*. 2001: CRC press.
4. Tepper, F. and L. Kaledin, *Nano aluminum as a combustion accelerant for kerosene in air breathing systems, in 39th Aerospace Sciences Meeting and Exhibit*. 2001.
5. Javed, I., S.W. Baek, and K. Waheed, *Autoignition and combustion characteristics of kerosene droplets with dilute concentrations of aluminum nanoparticles at elevated temperatures*. Combustion and Flame, 2015. **162**(3): p. 774-787.
6. Tianfu, Y., *Research and Application of Gelled Propellant*. Missiles and Space Vehicles 2002. **5**: p. 36-43.
7. Ciezki, H., et al. *Overview on the German Gel Propulsion Technology Activities: Status 2017 and Outlook*. in *7th European Conference for Aeronautics and Space Sciences, The Korean Society of Propulsion Engineers Spring Conference*. 2017.
8. Gan, Y. and L. Qiao, *Combustion characteristics of fuel droplets with addition of nano and micron-sized aluminum particles*. Combustion and Flame, 2011. **158**(2): p. 354-368.

9. Yan, Q.-L., et al., *Nanomaterials in Rocket Propulsion Systems*. 2018: Elsevier.
10. Bates, L., *Guide to the design, selection, and application of screw feeders*. 2000: Professional Engineering Pub.
11. Kresta, S.M., et al., *Advances in industrial mixing: a companion to the handbook of industrial mixing*. 2015: John Wiley & Sons.
12. Yan, D., et al., *Numerical modelling of twin-screw pumps based on computational fluid dynamics*. Proceedings of the Institution of Mechanical Engineers, Part C: Journal of Mechanical Engineering Science, 2016. **231**(24): p. 4617-4634.
13. Yan, D., et al., *Rotor profile design and numerical analysis of 2–3 type multiphase twin-screw pumps*. Proceedings of the Institution of Mechanical Engineers, Part E: Journal of Process Mechanical Engineering, 2017. **232**(2): p. 186-202.