



City Research Online

City, University of London Institutional Repository

Citation: Cockburn, E.S. (1992). Photocrosslinking reactions of stilbazolium salts.
(Unpublished Doctoral thesis, City, University of London)

This is the accepted version of the paper.

This version of the publication may differ from the final published version.

Permanent repository link: <https://openaccess.city.ac.uk/id/eprint/28494/>

Link to published version:

Copyright: City Research Online aims to make research outputs of City, University of London available to a wider audience. Copyright and Moral Rights remain with the author(s) and/or copyright holders. URLs from City Research Online may be freely distributed and linked to.

Reuse: Copies of full items can be used for personal research or study, educational, or not-for-profit purposes without prior permission or charge. Provided that the authors, title and full bibliographic details are credited, a hyperlink and/or URL is given for the original metadata page and the content is not changed in any way.

Photocrosslinking Reactions

Of

Stilbazolium Salts

by

Eleanor Stewart Cockburn

A thesis submitted for the Degree of
Doctor Of Philosophy
in the Department Of Chemistry of
The City University, London
October, 1992.

<u>INDEX</u>	<u>PAGE</u>
CHAPTER 1 - Polyvinyl Alcohol And Its Uses in Water Developable Photoresists For The Screen Printing Industry	
1.1 Introduction to screen printing	8
1.2 Preparation and properties of PVA	11
1.3 The modification of polyvinyl alcohol	20
1.4 Use of photosensitive polyvinyl alcohol solutions in screen printing	24
1.5 References	28
CHAPTER 2 - Introduction To Polymers Which Photocrosslink Via A [2 + 2] Cyclo-Addition Reaction	
2.1 Introduction to photochemistry	30
2.2 Introduction to [2 + 2] cyclo-addition reactions	41
2.3 Polymer types which crosslink via a [2 + 2] photocyclo-addition reaction	47
2.4 Excited complexes and their role in photocyclo-addition reactions	62
2.5 References	72
CHAPTER 3 - Photocrosslinking Of PVA Modified With Pendant Styrylpyridinium Groups	
3.1 Objective	77
3.2 Introduction	78
3.2.1 Synthesis of styrylpyridines	79
3.2.2 Preparation of modified PVA	82
3.2.3 Photochemistry of styryl pyridinium groups	84
3.2.4 Comparison of the rates of insolubilisation of modified PVA films	89

	<u>PAGE</u>
3.3 Results and discussion	92
3.3.1 Preparation of photosensitive materials	92
3.3.2 Examination of model compounds	94
3.3.3 A mechanistic study of the photocrosslinking of PVA films modified with pendant styryl pyridinium groups	99
3.3.4 Comparison of 2- and 4-SbQ modified PVA films	102
3.4 Conclusions	120
3.5 References	121
 CHAPTER 4 - Crosslinking Of Modified PVA Via A Mixed Cyclo-Addition Reaction	
4.1 Objective	124
4.2 Introduction	125
4.3 Results and discussion	129
4.4 Conclusions	155
4.4.1 Future work	156
4.5 References	157
 CHAPTER 5 - Polyvinyl Alcohol Modified With Styrylpyridiniumboronic Acids	
5.1 Objective	158
5.2 Introduction	159
5.3 Synthesis of boronic acids and esters	160
5.4 Synthetic uses of boronic acids and their esters	163
5.5 Results and discussion	164
5.6 Conclusions	181
5.7 References	182

	<u>PAGE</u>
CHAPTER 6 - Experimental	
6.1 Instrumentation	184
6.1.1 IR spectra	184
6.1.2 UV/VIS spectra	184
6.1.3 ¹ H NMR spectra	184
6.1.4 Fluorescence spectra	184
6.1.5 Mass spectra	185
6.1.6 Elemental analysis	185
6.1.7 Melting points	185
6.1.8 UV curing	185
6.1.9 Viscosity Measurements	186
6.2 Source of chemicals	186
6.3 Preparation of materials	187
6.3.1 Preparation of 13% polyvinyl alcohol solution	187
6.3.2 Preparation of 1-methyl-4-[2-(4-formylphenyl)ethenyl]pyridinium methosulphate (4-SbQ salt)	187
6.3.3 Preparation of 1-methyl-2-[2-(4-formylphenyl)ethenyl]pyridinium methosulphate (2-SbQ salt)	188
6.3.4 Preparation of 4-[2-(phenyl)ethenyl]pyridine	189
6.3.5 Preparation of 2-[2-(phenyl)ethenyl]pyridine	190
6.3.6 Preparation of 1-methyl-4-[2-(phenyl)ethenyl]pyridinium methosulphate	190
6.3.7 Preparation of 1-methyl-2-[2-(phenyl)ethenyl]pyridinium methosulphate	191
6.3.8 Preparation of 4-[2-(4-methylphenyl)ethenyl]pyridine	
6.3.9 Preparation of 1-methyl-4-[2-(4-bromophenyl)ethenyl]pyridinium	192

methosulphate

	<u>PAGE</u>
6.3.10 Preparation of 4-[2-(4-bromophenyl)ethenyl]pyridine	193
6.3.11 Preparation of 2-[2-(4-bromophenyl)ethenyl]pyridine	194
6.3.12 Preparation of 4-methylbenzene boronic acid	194
6.3.13 Preparation of 4-methoxyphenyl boronic acid	195
6.3.14 Preparation of 4-formylbenzene boronic acid	196
6.3.15 Preparation of 1-methyl-4-[2-(4-benzeneboronic acid)ethenyl]pyridinium methosulphate	196
6.3.16 Preparation of 4-cyanocinnamaldehyde	197
6.3.17 Preparation of diazomethane	198
6.3.18 Homogeneous modification of polyvinyl alcohol with various aldehydes	198
6.4 References	201

ACKNOWLEDGEMENTS

I would like to express my appreciation to the following:-

Prof. R. Stephen Davidson for his help and guidance throughout this project.

My fellow students in the Connaught Building, especially the inmates of 305, 307 and biochemical laboratories for their friendship. A special thanks goes to Dr. Patricia Moran for all her advice and kindness.

Sericol Group Limited, Broadstairs and SERC for the case award.

The Sericol staff for sharing their expertise with me but especially Dr. Julie Pratt and Dr. John Hamilton for their encouragement and belief in this project.

ABSTRACT

The chemistry and photochemistry of [2+2] cyclo-addition reactions used in photocrosslinking is briefly outlined.

A spectroscopic investigation into 2- and 4-styrylpyridinium modified polyvinyl alcohol for use in the screen printing industry is undertaken. It is shown that insolubilisation of lithographic systems is due to "cyclobutane" dimer formation and not to a crosslinking process involving nucleophilic attack by pendant hydroxyl groups upon pendant styrylpyridinium groups.

The 4-styrylpyridinium modified polyvinyl alcohol crosslinks at a faster rate than the 2-substituted derivatives. Evidence is provided for the enhanced aggregation of the 4-substituted polymer over the 2-substituted polymer. It is postulated that the quaternised nitrogen interacts with the hydroxyl groups of the polymer backbone such that the 4-styrylpyridinium units can easily align themselves in the correct orientation for dimerisation. UV (diffuse reflectance) and excitation spectroscopy indicate that the cyclo-addition reaction occurs via excited charge transfer complex formation.

Simple ethylenic aldehydes can be grafted onto polyvinyl alcohol. Evidence is provided for a mixed cyclo-addition reaction occurring when these modified polyvinyl alcohol solutions are physically mixed with styrylpyridinium modified polyvinyl alcohol. Thus the photosensitivity of the solution can be maintained with less styrylpyridinium salt. Again an excited charge transfer complex mechanism is proposed.

A new way of linking the styrylpyridinium group to the polyvinyl alcohol is investigated. Attachment via the borate group capitalises upon the fact that the predominant repeat group in polyvinyl alcohol is a 1,3-diol, since the 6 membered cyclic borate ester is more stable than the 5-membered ring system. Furthermore, attachment via the borate group occurs under neutral to basic conditions thereby avoiding unwanted acid catalysed condensation of the polyvinyl alcohol which occurs when the complexes with the aldehyde group are made.

CHAPTER 1

Polyvinyl Alcohol And Its Use In Water Developable Photoresists For The Screen Printing Industry

1.1 Introduction To Screen Printing

Screen printing is a process derived from the art of stencilling, the application of colours through areas cut from paper or other flat materials [1]. The term "photoresist" refers to a protective stencil formed by selective insolubilisation of a suitable material sensitive to light [2]. The stencils are supplied as a water dispersible liquid emulsion which is applied to a screen using a coating trough. The number of applications can range from one to eight coats depending on the strength and definition required. The screen is then left in the horizontal position to dry. The image is produced by laying a silver halide positive in contact with the coated screen which is then exposed to UV light in a exposure unit [3]. The image is then developed by spraying with cold water. The parts of the emulsion which have not been exposed to light are dispersible in water and washed away.

The basic items necessary for the screen printing process are :

1.Screen: this consists of a mesh stretched across and attached to a rigid frame, on which an image has been formed as described above.

2.Squeegee: a flexible rubber or plastic blade held in a rigid handle.

3.Print base: the base provides a surface for the substrate to be printed and the upper section secures the screen.

The printing process is executed by drawing the ink with a squeegee, held at a 60° angle, across the screen [1]. The ink is forced through the open parts of the stencil.

The screen process gives the highest dry film thickness of all the printing techniques, thus the deposited ink carries a higher pigment level which can give good light fastness and colour strength [1]. With the screen process any available resins and solvents may be used, provided that they are incorporated into a printable ink system. Also this system is the only process capable of printing onto irregular shapes and many substrates with various thicknesses of ink. The low make-ready costs and inexpensive materials that are used make this system very attractive to printers producing short or medium sized production runs, e.g. posters, plastic bottles, signs, textiles, ceramic tiles, printed circuit boards.

The main constituent of photosensitive screen printing emulsions is polyvinyl alcohol (PVA). It is combined with an inert filler, e.g. poly vinyl acetate or starch, a surfactant and a plasticiser, e.g. glycol, to produce a stable emulsion.

Aqueous solutions of PVA are stable upon storage but they must be protected from micro-organisms which are always present in the air and water. A biocide (0.1 - 0.5 % weight) must be used to give photosensitive PVA solutions a good shelf life [4].

1.2 Preparation And Properties Of PVA

Polyvinyl alcohol was the first totally synthetic colloid, a polyhydroxy water soluble resin [5]. The term "polyvinyl alcohol" is generally used to indicate a polymer of the general structure:-

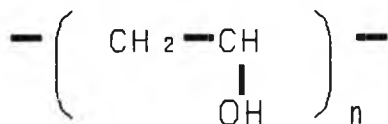

This representation does not take account of the many variables within the general structure. The principal structural variations within the polymer are chain length,

chain length distribution, chain branching, chain branch distribution, side chain stereoregularity and more specific to polyvinyl alcohol is the degree of hydrolysis. Thus a more satisfactory general representation would be :-

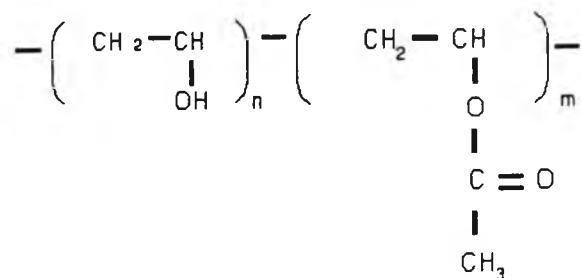

The first polyvinyl alcohol was prepared by Herrman and Haehnel in 1924 from the polymerisable ester, vinyl acetate since vinyl alcohol, the true monomer does not exist in the free state [6].

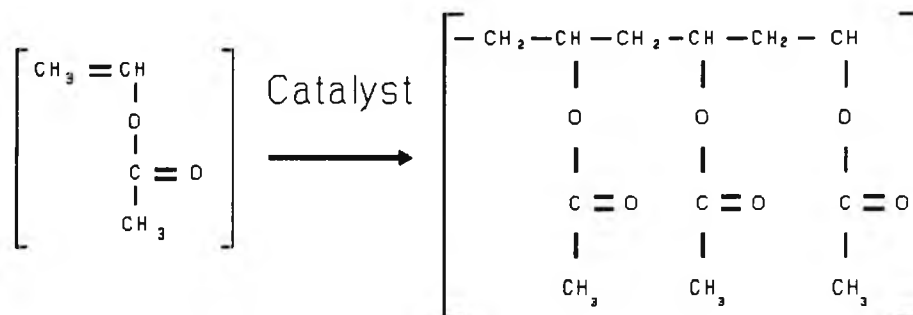

The reaction is exothermic, with addition of large quantities of monomer leading, after a slow start, to a build up of heat which is sometimes explosive. At this time, catalytically initiated polymerisations were not fully understood so that thermal polymerisations were carried out in light glass vessels with reaction times of up to a week. Almost simultaneously Hoechst began to investigate polymerisation using autoclaves, the catalytic effect of peroxides and the regulating effect of acetaldehyde [7]. Compounds such as benzoyl peroxide, lauroyl peroxide, t-butyl hydroperoxide, diisopropylperoxydicarbonate and azobisisobutyronitrile are commercially used in the free radical solution polymerisation of vinyl acetate. It has also been reported that organometallic compounds and chelates of second and third groups of the periodic table are efficient catalysts for vinyl polymerisation, again this is a free radical process [8,9].

There are four methods of polymerisation, each with its own characteristics (table 1.1) [10]. It can be seen that solution polymerisation is the most suitable for the production of PVA.

1. Bulk polymerisation - reaction mixture contains only monomer and initiator.

2. Solution polymerisation - reaction carried out in a solvent.

3. Suspension polymerisation - suspension of droplets (0.01 to 0.5cm) of water insoluble monomer in an aqueous phase.

4. Emulsion polymerisation - technique differs from the suspension method in that the particles are much smaller (0.05 to 5 microns) and the initiator is soluble in the aqueous phase rather than the monomer droplets. Aqueous emulsion polymerisation begins with a true solution of water soluble monomer and initiator, or with the solubilisation of insoluble monomers and initiators using surfactants.

Table 1.1: Polymerisation Characteristics

Polymerisation	Polymer Control	Properties	Comments
BULK	High viscosity, transfer addition	Branching, high carboxyl content	Highly exothermic, hot spots develop
SOLUTION	Easy, solvent addition	Excellent	Reduced viscosity
EMULSION	Easy, transfer agent	Branching, dark colour	Increased chain length
SUSPENSION	Easy, transfer agent	Branching, high carboxyl content	Avoids heat and viscosity build up

Polyvinyl acetate (PVAC) is converted to polyvinyl alcohol by hydrolysis [11]. The main methods of hydrolysis are usually grouped in the following classes:-

Alcoholysis

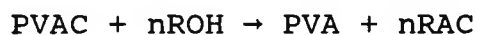

Hydrolysis

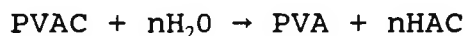

Direct Hydrolysis

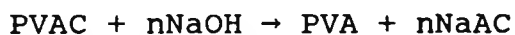

Aminolysis

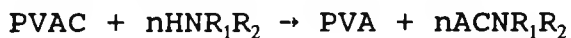

Ammonolysis

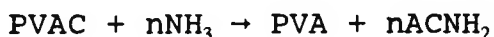

The following side reactions may also occur :-

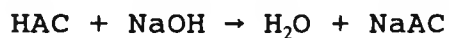
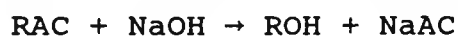

Table 1.2 shows the characteristics of each hydrolysis reaction.

Table 1.2: Hydrolysis Reactions And Their Characteristics

Catalyst	Medium	Reaction	comment
alkaline	MeOH	alcoholysis	economically good but difficult to control, distribution blocky
alkaline	H ₂ O/MeOH	hydrolysis	good colour and form, difficult to control, distribution blocky
alkaline	H ₂ O/solvent	hydrolysis	easy to control but recovery of NaOAc is uneconomical, very blocky
acid	MeO	alcoholysis	easy to control, random distribution
acid	H ₂ O	hydrolysis	easy to control, HOAc recovery is uneconomical, random distribution

During the synthesis of polyvinyl alcohol 1-2% of 1,2 glycol bonds are formed by head to head polymerisation [12]. It is known from carbohydrate chemistry that 1,2 glycol bonds can be cleaved by periodate oxidation in which the two carbon atoms each bear an oxygen atom either as a hydroxyl or carbonyl. This was first observed by Malaprade [13].



The mechanism of oxidation of 1,2 glycols was clarified by Buist and Bunton (fig 1.1) [14].

Fig 1.1: Periodate Oxidation Of Ethylene Glycol

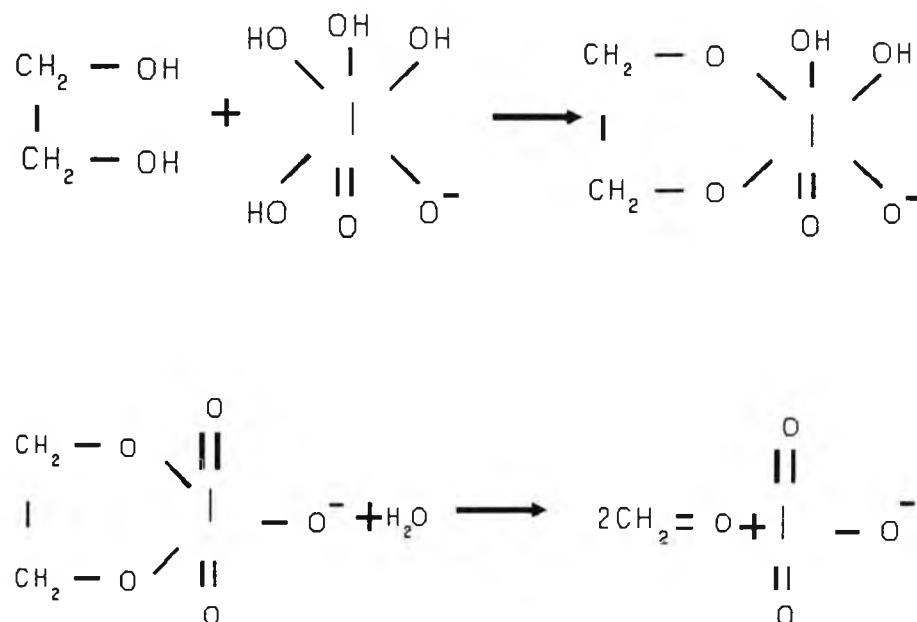

This knowledge allows us to reclaim expensive screens after use, as the periodate cleavage will reduce the molecular weight of the polymer thus enabling the polymer to be washed away with water. This is the principle reason why PVA is used in these photosensitive emulsions.

Polyvinyl alcohol is a white to cream granular powder which when protected from moisture can be kept almost indefinitely with excellent stability towards sunlight.

The physical properties of polyvinyl alcohol depend on its degree of polymerisation and hydrolysis (fig 1.2) [15]. Its many hydroxyl groups cause it to have a high affinity to water but the strong hydrogen bonding between the intra- and intermolecular hydroxyl groups works to impede the solubility

of the polymer in water. The residual acetate groups in partly hydrolysed polyvinyl alcohol are essentially hydrophobic and weaken the hydrogen bonding of the hydroxyl groups. These conflicting situations result in polyvinyl alcohols with very varied properties. The average degree of polymerisation depends upon the method and conditions of polymerisation whereas the degree of hydrolysis is dependent on the alcoholysis or hydrolysis reaction.

The degree of hydrolysis falls into two groups:-

1. Fully hydrolysed with a degree of hydrolysis greater than 98%.

2. Partly hydrolysed with a degree of hydrolysis between 87 to 89 %.

The partly hydrolysed group includes a subgroup with about 80% hydrolysis. Table 1.3 shows some of the commercially available polyvinyl alcohols. All commercially available polyvinyl alcohols are soluble in water, even on cooling, which is the only practical solvent as they cannot be dissolved by most common solvents [16]. The viscosity of these aqueous polyvinyl alcohol solutions is dependent upon molecular weight, concentration and slightly on temperature but degree of hydrolysis has no effect on viscosity. Therefore solution concentrations are limited by viscosity rather than degree of hydrolysis.

Table 1.3: Some Commercial PVA Grades (Gohsenol, as supplied by the Nippon Synthetic Chemical Industry Co., Ltd.)

Hydrolysis (mol %)	Degree of polymerisation	Molecular weight
99.4 - 100	2,600	114,946
98.5 - 99.4	2,350	104,387
98 - 99	2,000	88,840
98 - 99	1,800	79,956
86.5 - 89	2,600	127,500
86.5 - 89	2,350	115,244
86.5 - 89	2,000	98,080
86.5 - 89	1,700	83,368
86.5 - 89	1,450	71,108

PVA undergoes chemical reactions in a manner similar to other secondary polyhydroxylic alcohols namely acetalisation, esterification and etherification. It is this chemical reactivity which is the basis for the modification of PVA for use in the preparation of photosensitive emulsions.

1.3 The Modification Of Polyvinyl Alcohol

By modifying the polyvinyl alcohol backbone the properties of the resultant polymer are different from the initial polymer. Polyvinyl alcohol is highly reactive and is suitable for acetalisation, esterification and etherification [17]. Using these basic chemical reactions one can prepare varied polyvinyl alcohol polymers for many different uses including screen printing, by the introduction photosensitive moieties.

Acid acetalisation is the principal method for modifying polyvinyl alcohol. The main product of the reaction of polyvinyl alcohol and an aldehyde is a six-membered intramolecular acetal ring. There is also the possibility of intermolecular links being formed which could result in crosslinking and an increase in molecular weight. As has already been mentioned polyvinyl alcohol contains 1-2% of 1,2-glycol bonds which allow for the formation of a five membered ring. These possibilities are depicted in fig 1.3.

Fig 1.3:Acetalisation Of Polyvinyl Alcohol

Intramolecular acetalisation of 1,3 glycols

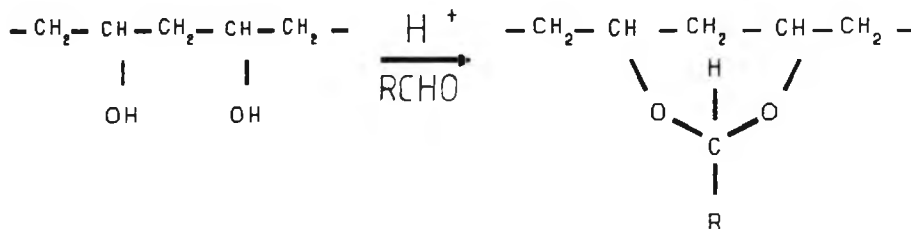

Intermolecular acetalisation

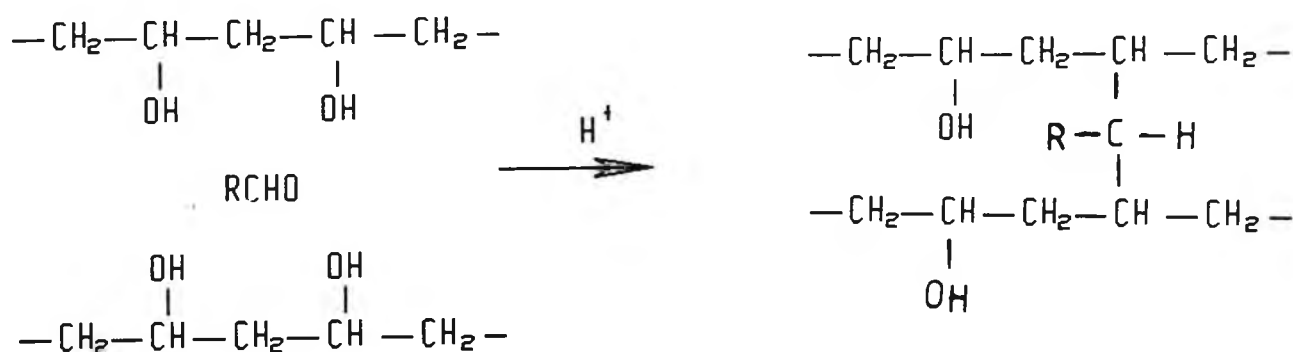

Intramolecular acetalisation of 1,2 glycols

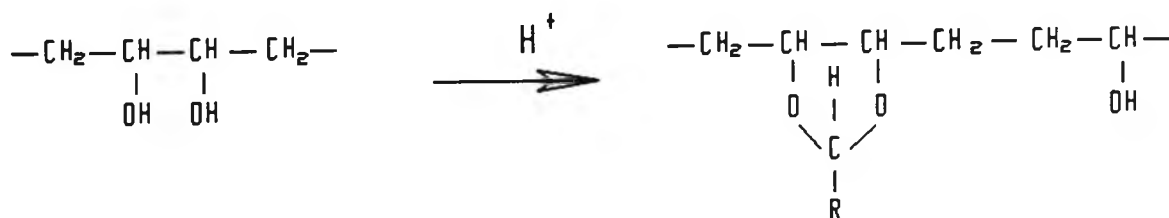

There are four ways to carry out the acetalisation reaction: a homogeneous method, a heterogeneous method, a precipitation method and a dissolution method [18,19,20,21].

1. Homogeneous method is carried out in an aqueous solution of polyvinyl alcohol, the reaction proceeding throughout in a homogeneous solution.

2. Heterogeneous method is carried out in heterogeneous phase with polyvinyl alcohol in the form of powder, film or fibre.

3. Precipitation method is carried out in an aqueous solution of polyvinyl alcohol causing the acetal to precipitate at about 30% acetalisation after which the reaction is continued in the heterogeneous system.

4. Dissolution method allows polyvinyl alcohol (suspended in a solvent for the acetal) to dissolve the reactants as the acetalisation proceeds then continuing the reaction as a homogeneous system.

For the preparation of photoresists, for the screen printing industry, the modified polyvinyl alcohol has to be in an aqueous solution. Also only small amounts of suitable aldehyde are necessary to produce these photosensitive systems. The homogeneous and heterogeneous methods of acetalisation are used. If the aldehyde is water soluble then the homogeneous method is by far the easiest procedure resulting in a solution which ready to be coated onto a screen and exposed [19]. However, by this method, any unacetalised moieties remain in the solution and may absorb light without contributing to an increase in the molecular weight ie insolubilisation. The efficiency of the system is thereby reduced. Alternatively, in the acetalisation of polyvinyl alcohol by a heterogeneous method any unreacted aldehyde is washed away at the filtration stage. Heterogeneous modification is very convenient for any water insoluble aldehyde [18]. As will be seen compounds like 2- or

4-styryl pyridinium salts have been grafted onto the PVA backbone by acetalisation for use in photosensitive systems.

Inorganic esters like sulphates, nitrates, phosphates and isocyanates can be used to modify the PVA chain [22]. However for use in the screen printing industry PVA has been esterified by organic units such as cinnamoyl chloride by reacting the acid chloride with PVA suspended in toluene at elevated temperature [23]. Internal ethers are formed by the elimination of H_2O , often with catalysis by mineral acids or alkali resulting in insolubilisation.

A system which has less toxicity than the dichromates is the diazo sensitised PVA system (fig 1.5) [28,29,30]. This system has a wide exposure latitude with a colour change during exposure. The major disadvantage of this system is that the diazo resin is only thermally stable under acid conditions so diazo emulsions must be supplied as a two pack emulsion having a short pot-life.

Fig 1.5 Diazo Sensitised PVA

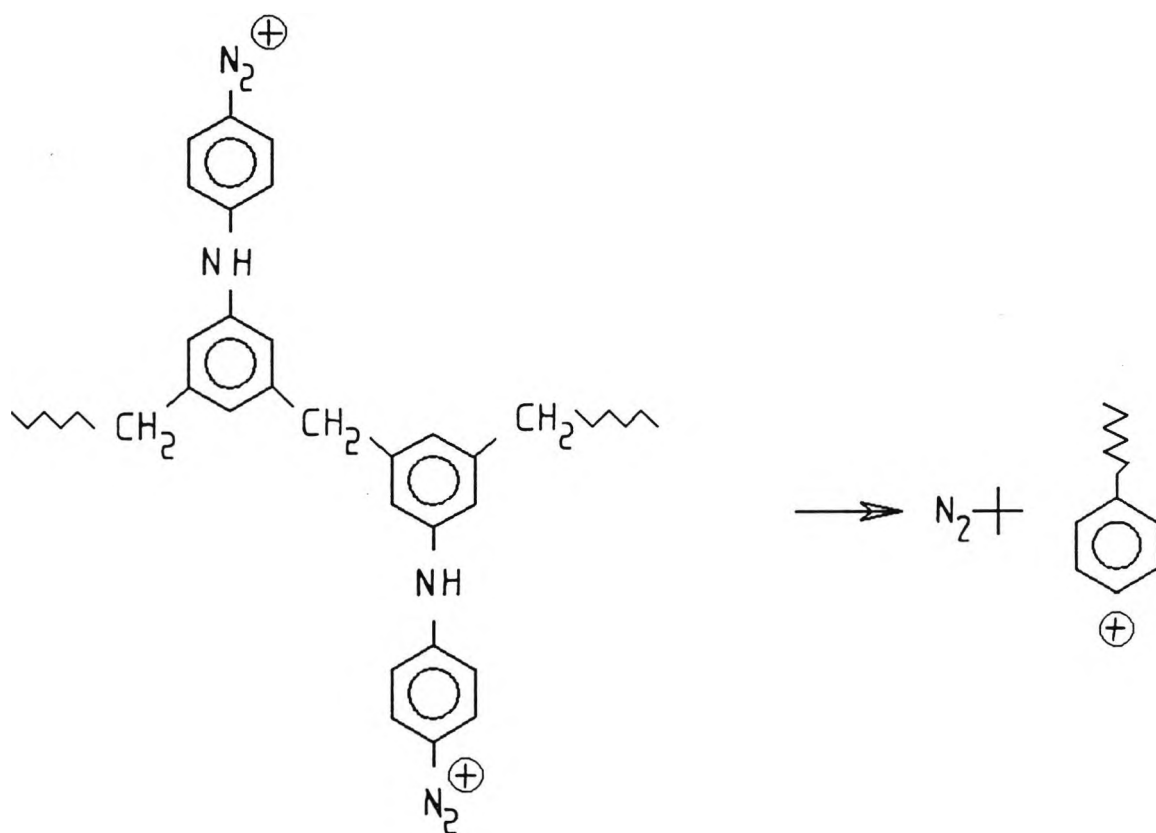

The modification of PVA chains by such compounds as cinnamates, chalcones and styryl pyridinium salts have been used in the screen printing industry [31]. The best of these have been the styryl pyridinium modified PVA (fig 1.6)

because these are highly sensitive systems and as a consequence very little modification of PVA is required. This system reacts via a singlet state without the intermediacy of free radicals and consequently the reaction can be carried out in the presence of oxygen. By contrast the curing of diazo and photopolymer emulsions is oxygen sensitive. This thermally stable system has a long pot and coated screen life with low toxicity and can be supplied as a one pot emulsion. Unfortunately it has less exposure latitude with no marked colour change on exposure.

Fig 1.6: Self Sensitising PVA

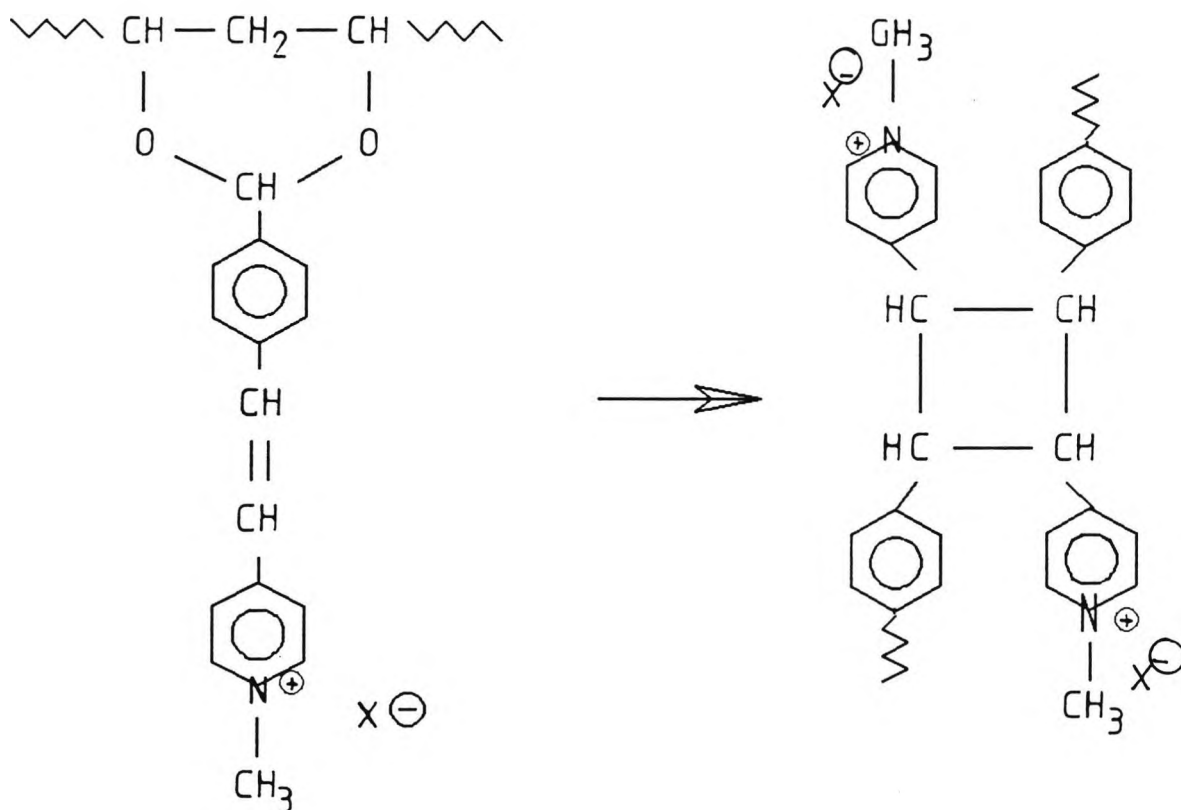

UV curing of these photosensitive films results in rapid insolubilisation of these films at room temperatures. Also the films are cast from aqueous solution so organic solvents can be avoided. UV curing is a low energy method but problems can exist in the photoinsolubilisation of thick layers and systems which use photosensitisers may incur oxygen inhibition.

1.5 References

1. J. Kosar, "Light sensitive systems: chemistry and application of non silver halide photographic processes; John Wiley and Sons, Walter Clark Ed., 1965
2. E.D. Roberts, Chemistry and Industry, April, 251 (1985)
3. J. Finter, Mol. Cryst. Liq. Cryst. Inc. Nonlin. Opt., 161, 231 (1988)
4. Vinol Product Handbook, Air Products And Chemicals, Inc, Allentown, Pa (1980)
5. C.A. Finch, "Chemistry and technology of water-soluble polymers," Plenum, London , 1983
6. US Patent, 1,672,156 (1928)
7. Consortium fur elektrochemische industrie G. m. b. H, Ger. Pat., 483,780 (1924)
8. T. Nakata, T. Otsu and M. Imoto, J. Polym. Sci. A., 3, 3383 (1965)
9. T. Nakata, T. Otsu and M. Imoto, J. Macromol. Chem., 1, 553 (1966)
10. J.M.G. Cowie, "Polymers: Chemistry and physics of modern materials, " International textbook company, 1973
11. K. Noro, "Polyvinyl alcohol, (Ed. C.A. Finch)", John Wiley and sons, Inc., New York, 1973
12. P.J. Flory and F.S. Leutner, J. Polym. Sci., 3, 380 (1948)
13. I. Malaprade; ~~Bull. Soc. chim. France~~, 43, 683 (1928)
14. G.J. Buist and C.A. Bunton; J. Chem. Soc., 1406 (1954)
15. D.L. Cincera; Kirk-Othmer encyclo. of chem. technol., third edition, 23, 848 (1983)
16. A. Harreus and W. Zimmerman, Kunstharz Nachrichten, no. 19,24 (1983)
17. K. Toyoshima, "Polyvinyl alcohol, (Ed. C.A. Finch)", John Wiley and sons, Inc, NY, chapter 15, 1973
18. K. Ichimura and T. Komatsu, J. Polym. Sci., A, Polym. Chem., 25, 1475 (1987)
19. K. Ichimura and S. Watanabe, J. Polym. Sci, Polym. Chem. Ed., 20, 1419 (1982)
20. L.A. Pilato and E.R. Wagner, Brit. Pat., 1,199,651 (1970)
21. Union Carbide Corp., Brit Pat., 1,100,652 (1970)

22. C.A. Finch, "Polyvinyl Alcohol, (Ed. CA Finch)", John Wiley and Sons, Inc., NY, chapter 9, 1973
23. L.M. Minsk, J.G. Smith, W.P. Van Deusen and J.F. Wright, J. Appl. Polym. Sci., 2, 6, 302 (1959)
24. S. Peter Pappas, "UV Curing: Science And Technology," second edition, Technology Marketing Corporation, 1980
25. K.B. Wiberg, "Oxidation In Organic Chemistry, (Ed. K.B. Wiberg)", Academic Press, NY, chapter 2, 1962
26. U.K. Klaning and M.C.R. Symons, J. Chem. Soc., 977 (1960)
27. U.K. Klaning, Acta. Chem. Scand., 12, 576, 807 (1958)
28. G. Kogel, US Patent, 2,099,404 (1937)
29. G. Kogel and R. Zahn, Ger. Pat., 651,958 (1935)
30. M. Hepher, J. Phot. Sci., 12, 181 (1964)
31. G.E. Green and B.P. Stark, J. Macro. Sci. - Revs. Macro. Chem., C21 (2), 187 (1982)

CHAPTER 2

Introduction To Polymers Which Photocrosslink Via A [2 + 2]

Cyclo-Addition

2.1 Introduction To Photochemistry

Photochemistry is the study of chemical changes brought about by the action of UV or visible light and there are many text books on the subject. This chapter merely provides a basic introduction to the creation, general properties and decay pathways open to excited states [1, 2, 3 and 4]. UV and visible light make up part of the electromagnetic spectrum and can be described in terms of an oscillating electric field and an oscillating magnetic field in planes that are perpendicular to each other and to the direction of propagation. This wave description of light is complimented by a particle description in which radiation is considered to be emitted, transmitted and absorbed in discrete units; photons. The energy of photons is related to the frequency (ν) of the radiation by equation 2.1.

$$E = h \nu = (h c) / \lambda \quad \text{Equation 2.1}$$

[where h = Planck's constant, c = velocity of light, ν = frequency and λ = wavelength of radiation]

Absorption of a photon may cause the promotion of an electron from the ground state to an excited state (Fig 2.1).

Fig 2.1: Stylised Molecular Orbital Diagram For An Organic Molecule, Showing Some Of The Orbitals And Their Occupancy (a) In The Ground State, And (b) In Excited State

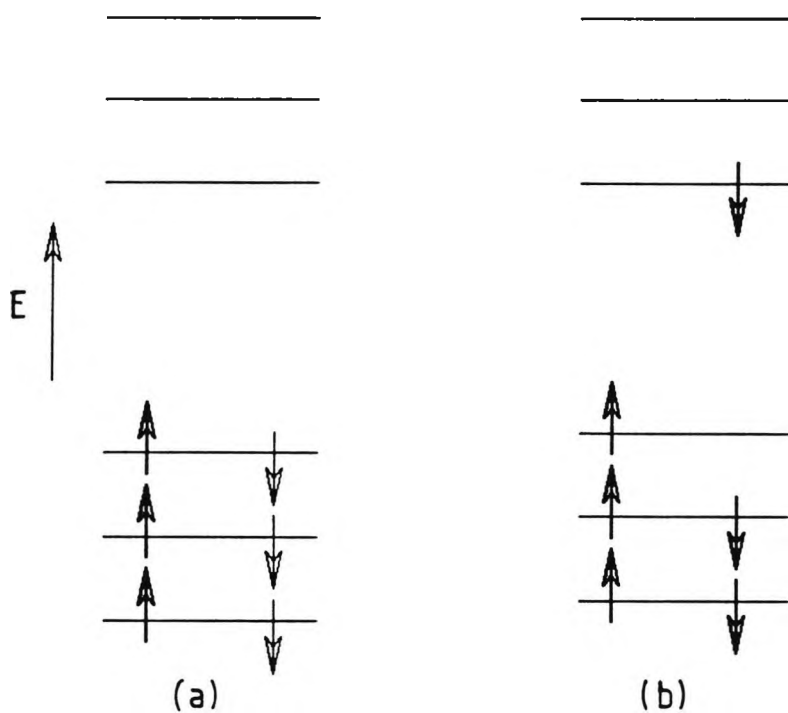

The electronically excited state is a distinct species having a finite lifetime. Thus the physical and chemical properties of the excited states differ from those of the ground state. There are two fundamental laws of photochemistry. First, the Grotthus-Draper law states, that only the light absorbed by a molecule can be effective in producing photochemical change in that molecule. The second law is the Stark-Einstein law which states that the primary photochemical act involves absorption of just one photon by a molecule. Exceptions to this second law arise when very intense light sources, such as lasers, are employed, and the probability of concurrent or subsequent absorption of two or more photons is no longer negligible.

Molecular orbital theory is the most convenient qualitative framework to describe the formation of electronically excited states by the absorption of light. The inner-shell electrons of the constituent atoms of a molecule are assumed to remain unaltered in the molecule itself, linear combinations of the valence shell atomic orbitals then provide molecular orbitals that can be used to describe the "outer" electronic structure in the molecule. When single atomic orbitals from the two adjacent atoms are combined, they produce two molecular orbitals: one of higher energy (antibonding orbital) and one of lower energy (bonding orbital) than the separate atomic orbitals (fig 2.2).

Fig 2.2: Schematic Diagram Of A Linear Combination Of σ And π Orbitals And Its Effect On Orbital Energy

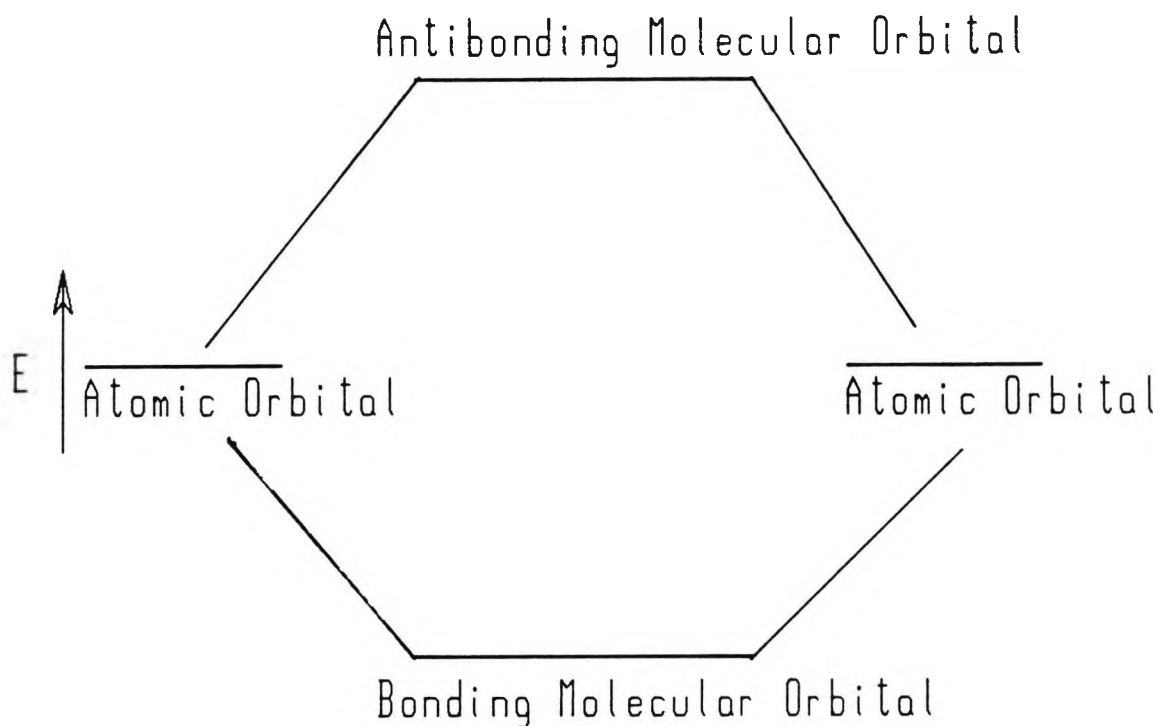

The combination of atomic S orbitals lead to orbitals that are completely symmetrical about the internuclear axis called sigma (σ) or sigma-star (σ^*) orbitals, which are bonding and anti-bonding respectively. The combination of parallel atomic p orbitals called pi (π) or pi-star (π^*) orbitals which are antisymmetric about a plane that includes the internuclear axis. A third type of orbitals is denoted as an n orbital. These orbitals are usually non-bonding, being of much the

same energy as in the corresponding isolated atom. A pair of electrons occupying an n-orbital is often envisaged as a lone pair of electrons on a particular atom.

The interaction of matter with UV or visible light results in excitation of outer electrons to a higher energy level. The types of electronic transitions can be classified according to the orbitals involved. The types of electronic transitions associated with organic molecules are illustrated in fig 2.3.

Fig 2.3: Stylised Diagram Of Electron Excitation Processes In Organic Molecules (where n = non-bonding orbitals, σ and π = bonding orbitals, σ^* and π^* = antibonding orbitals)

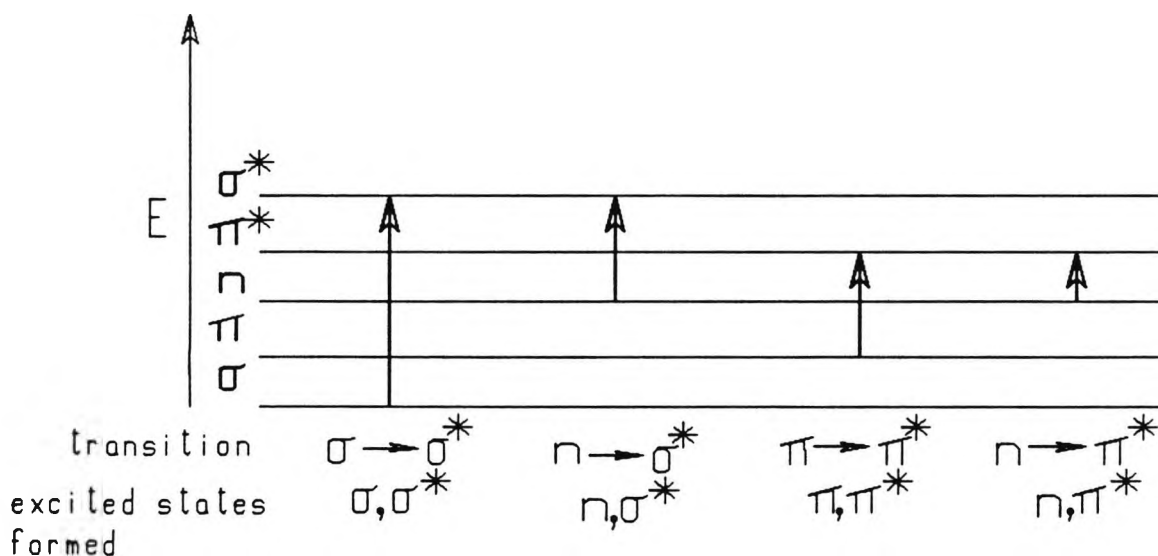

The $n-\sigma^*$ transitions are partially forbidden, giving rise to weak absorptions in a range of molecules, eg R-X, R-OH, R-SH and R-NH₂. The promotion of a non-bonding electron into an antibonding orbital results in efficient dissociation of the molecules upon irradiation, e.g. in the near UV. As the $\pi-\pi^*$ and $n-\pi^*$ transitions often require the least energy they are

involved in many photochemical reactions of organic molecules. $\pi-\pi^*$ transitions are allowed and give rise to intense absorptions by compounds such as alkenes. $n-\pi^*$ transitions are characteristic of molecules of molecules possessing multiply bonded heteroatoms, eg C=O, N=O, C=N and C=S. These $n-\pi^*$ transitions are symmetry and/or overlap forbidden giving rise to weak absorptions usually at the longest wavelength.

The ground states of most molecular species are singlets, ie all the electrons are paired. The resultant electronically excited state has two unpaired electrons in different orbitals. The usual situation is for them to have opposing spin, therefore having an overall zero spin and described as a singlet state. If the two spins are parallel the state has a non-zero overall spin and is a triplet state. The singlet and triplet states are distinct species with differing chemical and physical properties. The shorter lifetime and higher energy of the singlet compared with the triplet excited state may be attributed to a difference in electron spin. The longer lifetime of an excited triplet species reflects the need for a spin inversion to accompany any deactivation. Singlet excited states have lifetimes in the range 10^{-9} - 10^{-3} seconds. In similar electronic levels the triplet state is always of lower energy than the singlet state. This is in accordance with Hund's rule which states that the state with the highest multiplicity is the most stable.

The photophysical processes involved in the interconversion and deactivation of excited states are represented in a Jablonski diagram (fig 2.4) [5].

Fig 2.4: Jablonski Diagram Showing Some Of The Radiative ($h\nu_f$ = fluorescence; $h\nu_p$ = phosphorescence) And Non-Radiative (vc = vibrational cascade; IC = internal conversion; ISC = intersystem crossing) Processes Available To Molecules.

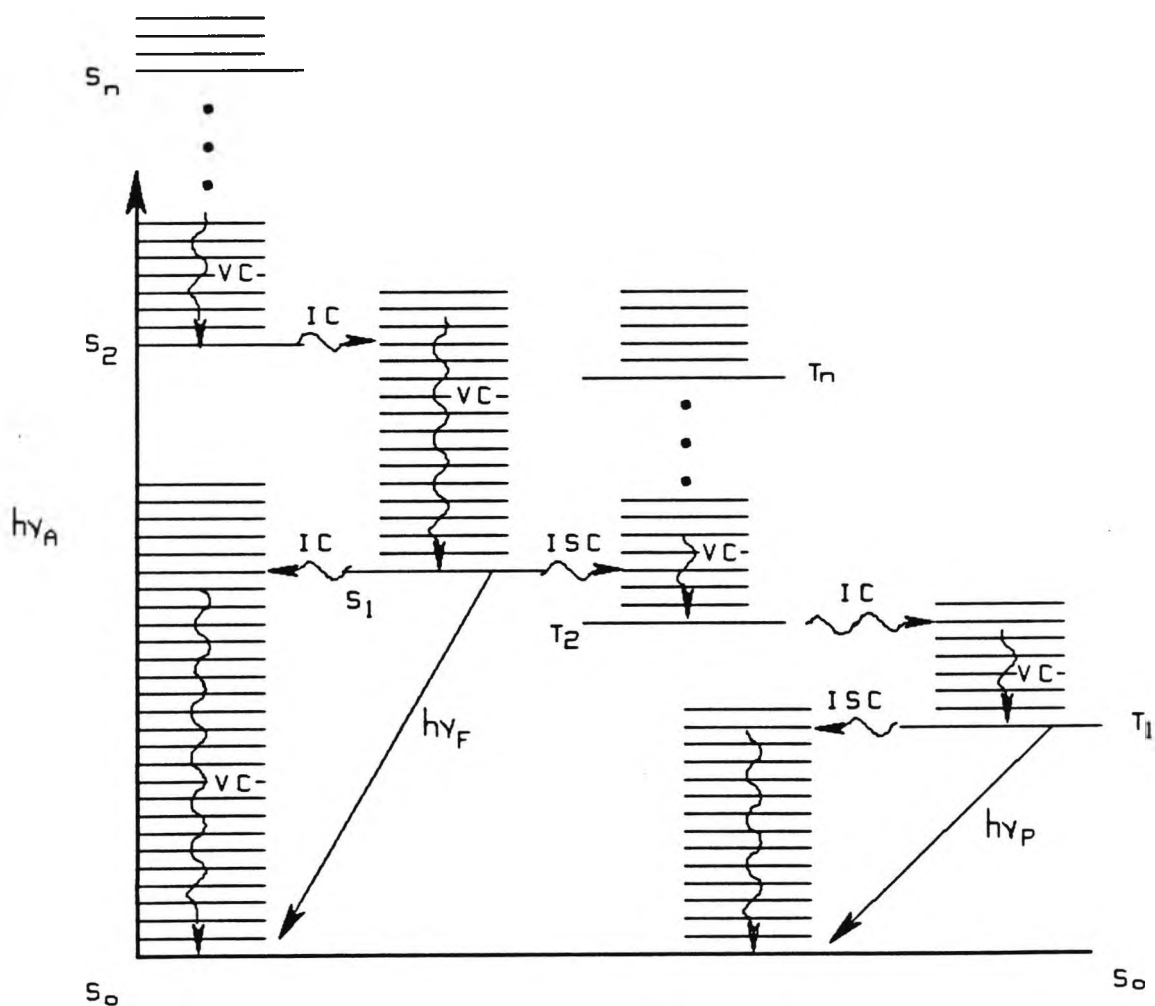

The energy levels to which an electron is initially promoted will depend upon the energy of the photon absorbed. According to the Frank-Condon principle, the time required for absorption of a photon is very small compared to the period of vibration of most molecules, which is of the order of 10^{-13} . Consequently, during the absorption process the nuclei do not alter their relative positions or their kinetic energies appreciably. This absorption of a photon does not exactly match the energy gap between ground and excited states and so usually produces a state which is excited rotationally and vibrationally, as well as electronically. In highly dilute gases, where collisional deactivation is slow, Frank-Condon excited states can actually be observed spectroscopically. However, in liquids and solids, the combination of a dense distribution of excited states and high collision frequencies between the molecules cause rapid relaxation of vibrational and rotational modes to occur very efficiently, in about 10^{-11} seconds, so that only molecules in the lowest vibrational level of the first excited electronic state persist long enough to be important photochemically.

If the electron is excited to a higher electronic state ie S_2 , there is a rapid process called internal conversion (IC) which converts the higher singlet state to the lowest excited singlet. In general, electronic conversions between states of the same multiplicity are known as internal conversion (IC). Whereas electronic transitions between states of differing multiplicity are known as intersystem crossing (ISC). Internal conversion and inter-system crossing occur between degenerate vibrational and rotational levels of different

electronic states of the same molecule. The rates of these processes decrease as the energy gap between the electronic levels, in their lowest vibrational states, increases. Although intersystem crossing is a spin forbidden process it takes place as a result of spin-orbit coupling, by which singlet and triplet states are mixed. Thereby reducing the restriction on their interconversion. These processes are similar in that they involve a conversion of electronic energy to vibrational energy which is followed by rapid relaxation to the lowest vibrational level of the lowest excited state. They occur without emission of a photon of light and hence are known as radiationless process.

When an excited singlet state emits a photon, the state is normally converted to the ground state, which is also a singlet state. Such a radiative process in which there is no overall change of spin is spin-allowed and is called fluorescence. Phosphorescent emission is another radiative process whereby a transition between states of differing multiplicity takes place, usually T_1 and S_0 . Because the spin multiplicity changes the process is spin-forbidden. Consequently, the lifetime (τ) of a triplet excited state is considerably longer than that of the corresponding singlet excited state.

Excitation of a ground state molecule by energy transfer from another excited species is termed quenching. For an excited state donor molecule D (sensitiser) and a ground state acceptor (quencher), three modes of energy transfer are possible, (a) - (c), are possible:



There are two mechanisms by which energy-transfer quenching can occur. The first of those is the Coulombic or Forster dipole-dipole coupling, which operates through mutual repulsion of the electrons in the two molecules. It is effective over relatively large distances, up to 5nm in some systems. This transition is spin allowed and so the transition dipole moment is large. Alternatively the Dexter exchange mechanism, in which reorganisation with a transient complex formed on close approach of the molecules involved have triplet multiplicity and thus are spin forbidden transitions. This is a shorter range phenomenon than dipole-dipole energy transfer. The most commonly encountered energy transfer process in organic photochemistry are outlined in fig 2.5.

Fig 2.5: Energy Transfer Processes

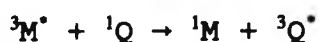

In most situations singlet energy transfer takes place mainly by the dipole-dipole mechanism, whereas triplet energy transfer occurs largely by an exchange mechanism. An overriding consideration for both types is that efficient transfer occurs only if it is energetically favourable, that is if the excited state energy of M is greater than that of Q.

Electron transfer quenching of the excited states of organic molecules can occur in an encounter complex via an excimer or exciplex (fig 2.6). These encounter complexes will be explained in greater detail later in this chapter.

Fig 2.6: Electron Transfer Quenching

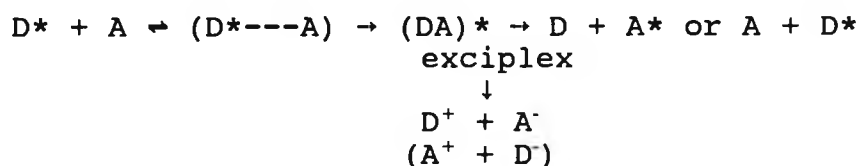

Energy transfer can be used to generate an excited state. This represents a good method for making triplet states, especially for those systems where intersystem crossing from the excited singlet state is inefficient. When applied in this sense, the name sensitisation is given to an energy transfer process.

2.2 Introduction to [2 + 2] Cyclo-addition Reactions

Cyclo-addition reactions are of considerable importance in synthetic organic chemistry. In a cyclo-addition reaction, two sigma bonds are formed to give a new ring structure derived from each of the reacting units [6]. The rationalisation of concerted reactions, by Woodward and Hoffman [7 and 8], in terms of the conservation of orbital symmetry during the course of the reaction, has given insight into thermal and photochemical cyclo-additions. Cyclo-addition reactions are not all concerted and may proceed via a variety of distinguishable routes.

One of the simplest classes are [2+2] cyclo-additions, such as the reaction of two alkenes to form a cyclobutane ring. The formation of cyclobutane from two ethylene molecules provide the simplest example of a $[\pi_2+\pi_2]$ cyclo-addition reaction. By considering the approach of the two ethylene molecules and applying the principle of orbital symmetry conservation to the reaction, predictions can be made about the allowed and forbidden nature of possible reactions in the ground and excited states.

The planes of the two ethylene molecules are assumed to be parallel as they approach each other, the cyclo-addition reaction is suprafacial to each component and may be represented formally as a $[\pi_{2S}+\pi_{2S}]$ process (fig 2.7).

There are two mirror planes which bisect the bonds made or broken in the reaction and the orbitals concerned must be

classified as symmetric (S) or antisymmetric (A) with respect to both symmetry elements. Only those bonding and antibonding orbitals which are specifically involved in the reaction, need to be considered, i.e. the π and π^* orbitals of each ethylene, and the σ and σ^* orbitals of the cyclobutane.

In this way a correlation diagram of the molecular orbitals of the reactants and products is constructed; the approximate energy levels of the molecular orbitals of reactants (two ethylene molecules) are placed on one side and those of the products on the other.

Fig 2.7: Stylised Diagram Of The Parallel Approach Of The Two Ethylene Groups And The Two Mirror Planes M1 And M2

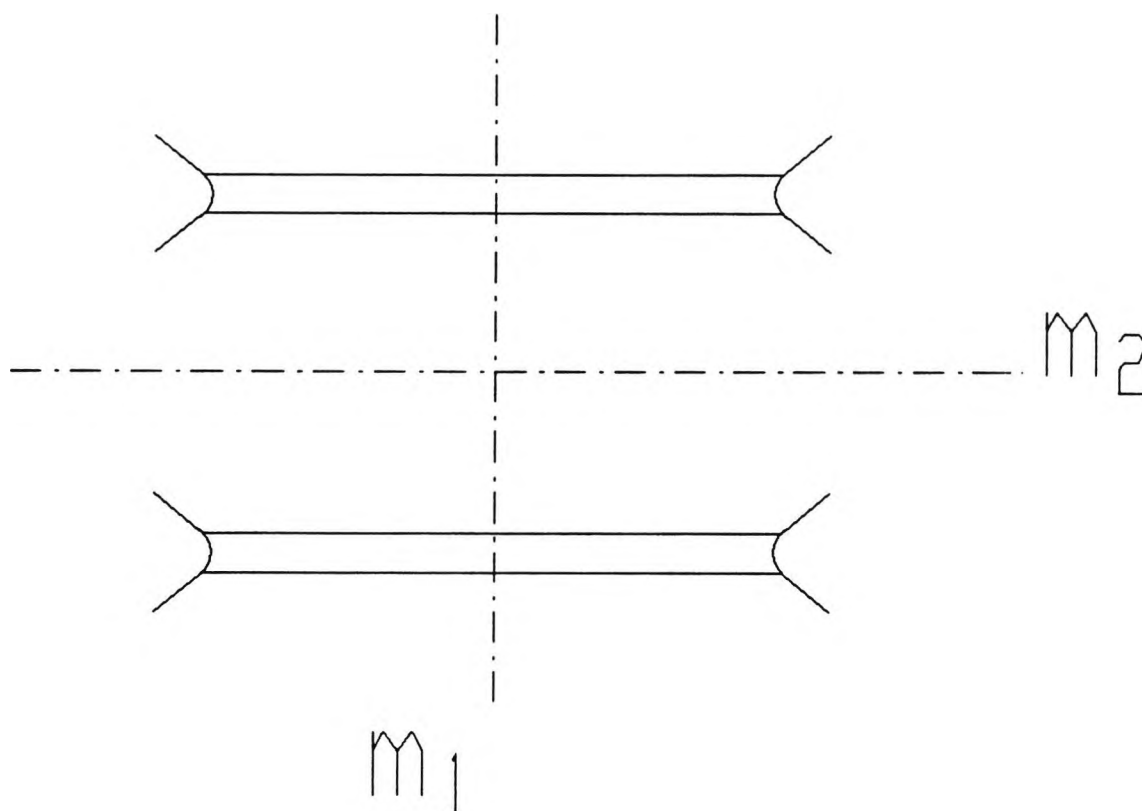

In the ground state, the direction of approach of the two ethylene molecules leads to the $\pi_1+\pi_2$ and $\pi_1-\pi_2$ orbital combinations of the two ethylene molecules. The four reactant π levels: $\pi_1+\pi_2$, $\pi_2-\pi_2$, $\pi_1^*+\pi_2^*$ and $\pi_1^*-\pi_2^*$ are then projected onto a plane passing through the four carbon atoms. Each set is then classified as symmetric or antisymmetric with respect to m_1 and m_2 respectively (fig 2.8).

Fig 2.8: Energy Levels Of Ethylene π Orbitals At A Finite Distance

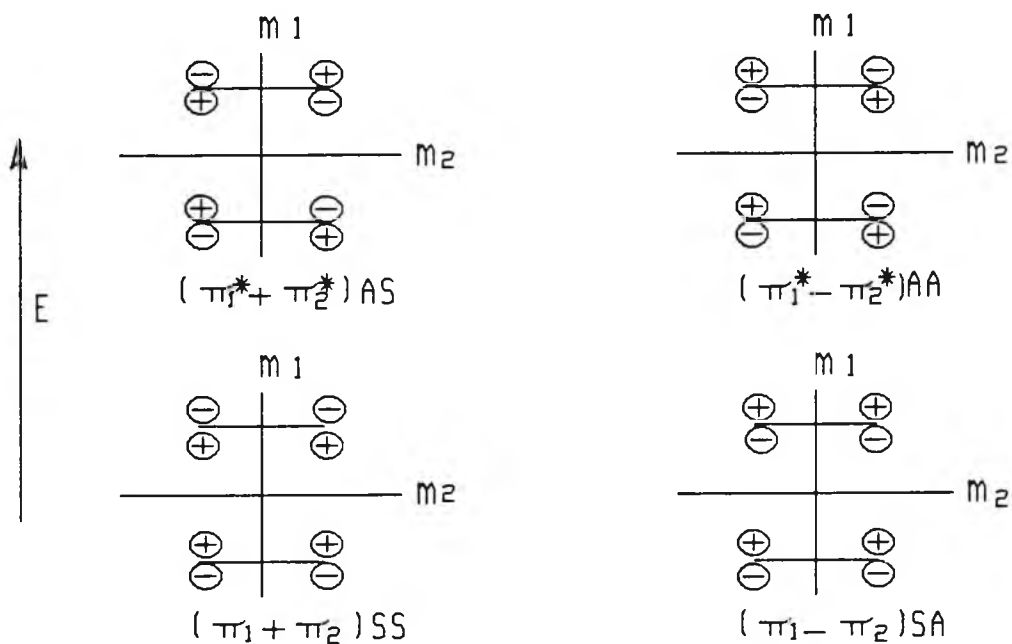

Similarly, the orbitals of the cyclobutane product can be considered by taking the combinations , $\sigma_1+\sigma_2$, $\sigma_1+\sigma_2$, $\sigma_1^*+\sigma_2^*$ and $\sigma_1^*-\sigma_2^*$ with respect to the symmetry planes; m_1 and m_2 (fig 2.9).

Fig 2.9: Energy Levels Of Cyclobutane σ Orbitals

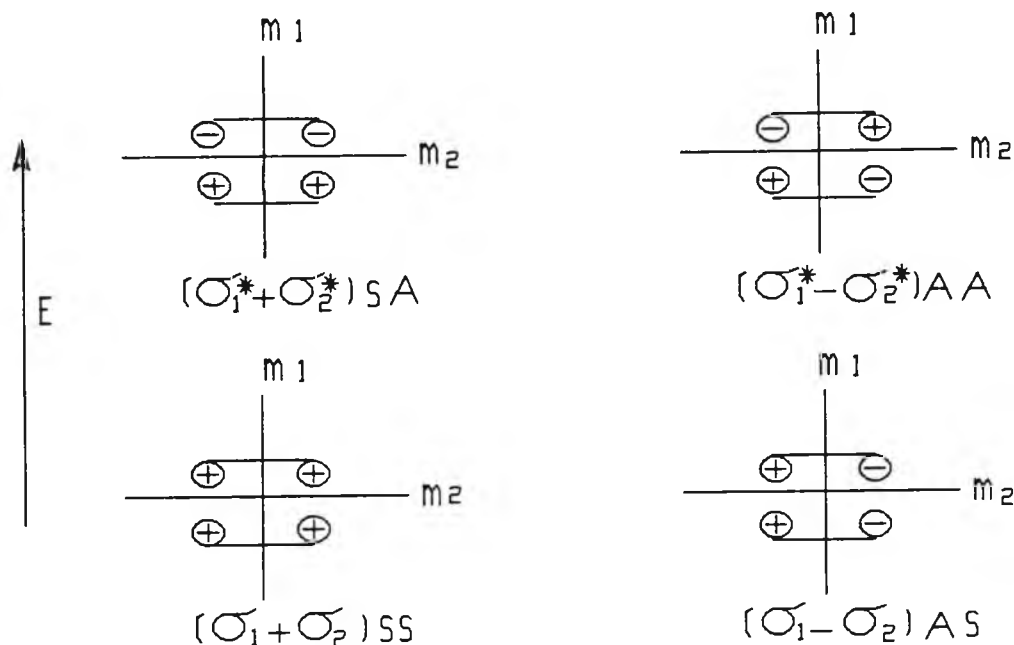

From this treatment the correlation diagram for the reaction of the two ethylenes to give cyclobutane can now be drawn (2.10).

Fig 2.10: Correlation Diagram For The Formation Of Cyclobutane From Two Molecules Of Ethylene

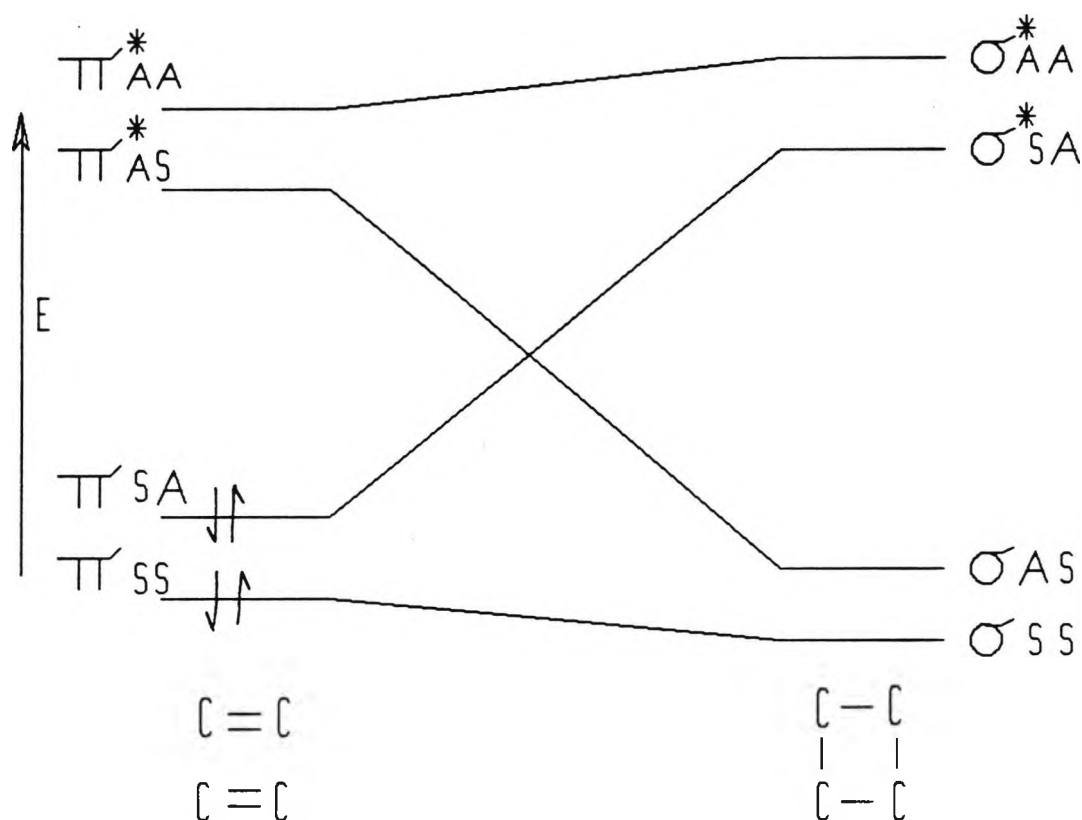

From fig 2.10, it can be seen that for the ground states of two ethylene molecules to react involves a large energy rise since two of the electrons finish up in an excited state level of cyclobutane. This is clearly an unfavourable high energy process, and the magnitude of the energy barrier would be approximately the energy required to raise two bonding electrons to the non-bonding electron level (ca. 481 KJmol^{-1}). Similarly, for cyclobutane to rupture in a concerted manner, the ethylenes would be produced with 2 electrons in the antibonding AS orbital. The thermal ground state $[\pi 2S + \pi 2S]$ cyclo-addition reaction is thus symmetry forbidden.

If one electron is promoted to the π^*_{AS} orbital as in a photochemical reaction, then the previously mentioned rise in energy to the σ^*_{SA} orbital is provided by the energy of the π_{AS} orbital decreasing to the bonding level σ_{AS} orbital. The photochemical reaction is both symmetrically and energetically allowed.

Alternatively, this reaction can occur when the ethylenes approach in orthogonal planes. This involves addition to one component in a suprafacial manner and an antarafacial addition to the other component (fig 2.11). This alternative process, a $[\pi 2s + \pi 2a]$ process, is symmetry allowed for the ground state reaction, but requires high energy steric interactions in the transition state and will only be favoured when the ethylenes are twisted.

Fig 2.11: $[\pi 2s + \pi 2a]$ Cyclo-addition

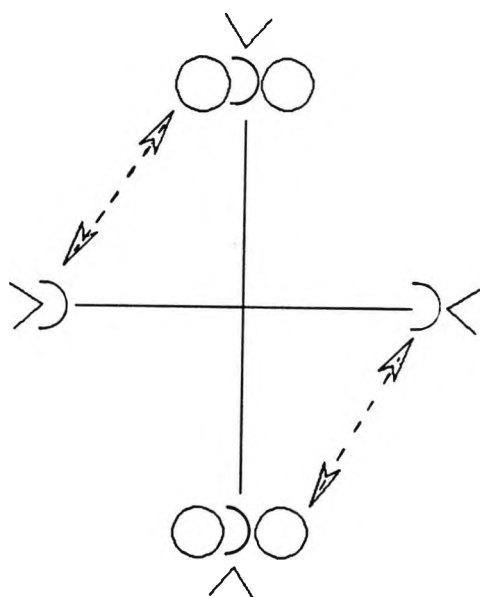

By taking the geometry of addition into account more detailed selection rules can be drawn up (table 2.1).

Table 2.1 Selection Rules

allowed in ground state	forbidden in ground state
forbidden in excited state	allowed in excited state
$M_s + N_a$	$M_s + N_s$
$M_a + N_s$	$M_a + N_a$

(Where M and N are the number of π electrons from the two reacting molecules)

2.3 Polymer Types Which Crosslink Via A [2 + 2] Photocyclo-Addition Reaction

The process whereby the absorption of UV light triggers off the conversion of a thin film of liquid to a hard coating is described as UV curing. In polymer systems, cyclo-addition reactions are used to create crosslinks thereby causing a large increase in molecular weight [9, 10, 11, 12 and 13]. The chemistry of photocyclo-addition reactions goes back to the discovery by Fritsch in 1867 of the dimerisation of anthracene [14]. These dimerisations have proven to be valuable reactions for the crosslinking of suitably substituted photosensitive polymers [13 and 14].

Polyvinyl cinnamate is one of the best known examples of a material which becomes insoluble via a photocyclo-addition process [15 and 16]. The cinnamate moiety can be introduced as a pendant group onto a number of polyhydroxylic polymers

such as PVA or high molecular weight Bisphenol A epoxy resins. Alternatively, these groups can be incorporated into the backbone of the polymer, by for example, polycondensing 4-carboxycinnamic acid or p-phenylenediacrylic acid with diols to produce linear polyesters. Polystyrene has been modified by the attachment of a pendant 4-dimethylamino-cinnamate ester group. This system shows charge transfer characteristics in its absorption and emission spectra. Photocrosslinkable polymers containing cinnamic acid derivatives made by the reaction of 4-vinyl benzaldehyde with malonic acid derivatives have also been studied [17]. Recently poly(cinnamoyl crown ethers) have been prepared for use as ion complexing agents. The fixation of the neighbouring crown ethers by the photodimerisation strongly enhances their cation binding ability [18]. The photosensitivity of cinnamate modified polymers can be enhanced by mixing blends of electron donating and accepting substituted polyvinyl cinnamates; cross dimers are predominately formed [19, 20 and 21]. It has been shown that the dimensions of cinnamoyl polymer coils in solution has an effect on the intra/inter product ratios [22]. Irradiation of dilute solutions of the polymer leads to contraction due to intramolecular dimerisation. As the concentration is increased the amount of intermolecular dimerisation increases and this increases the volume of the polymer coils as the molecular weight increases.

Fig 2.12: Photocyclo-addition Reaction Of Polyvinyl Cinnamate

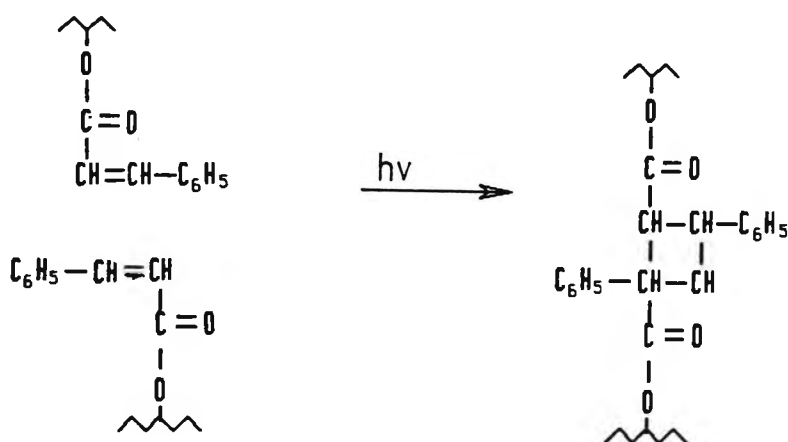

Furylacrylate, cinnamylideneacetate, benzylidene, furfurylidene and cinnamylidenecyanoacetic ester have also been used in the preparation of these light sensitive polymers [23-26]. Poly(vinyl 2-furylacrylate) cannot be prepared by using the usual conditions involving reacting PVA and 2-furylacryloyl chloride in pyridine at elevated temperatures since the reaction mixture produces gels on heating. Alternatively poly(vinyl 2-furylacrylate) can be easily prepared by the reaction of PVA and 2-furylacryloyl chloride in an aqueous alkaline process at -8°C to -5°C .

Spectroscopic studies of trans β -2furylacrylic acid by Ghosh and Misra have shown that both photopolymerisation and photodimerisation occur in the crystalline state [27]. The centrosymmetric β -truxinic dimer was formed by the reaction of the exocyclic $c=c$ double bonds of the two nearest neighbouring monomers. Whereas polymerisation occurs by the reaction of exocyclic $c=c$ double bonds with the $c=c$ double bonds of the furan ring of its nearest neighbour. As a result the furan rings get partially reduced [27]. In poly(vinylcinnamylidene acetate) and related compounds, the double bond adjacent to $C=O$ has greater reactivity than the double bond adjacent to the phenyl group. The mechanism of photocrosslinking of these polymers of these polymers is similar to that of poly(vinyl cinnamate) and will be discussed later. The photosensitivity of poly(vinyl-2-furylacetate) is slightly higher than the others including poly(vinyl cinnamate). All these polymers dissociate into monomeric units by irradiation with 254nm, except poly(vinyl cinnamate) which does not undergo photoreversibility because of the very low efficiency of light absorption by the photodimers of cinnamic acid.

Chalcone units also undergoes [2+2] cyclo-addition as well as isomerisation on irradiation with UV light. The isomerisation reaction can be almost completely suppressed by the introduction of bulky groups into chalconic resins. Similarly these groups can be introduced as pendant groups by the condensation of polyvinyl acetophenone with benzaldehyde [28 and 29], the addition of *p*-isocyanatobenzalacetophenone to PVA [30], by Friedel-Crafts reaction of polystyrene with

cinnamoyl chloride [31]. Alternatively chalcone type derivatives can be incorporated into the main polymer backbone. For example, 4,4'-dihydroxy chalcone is obtained by the condensation of p-hydroxybenzaldehyde with p-hydroxyacetophenone [32-35]. Also the condensation of p-hydroxybenzaldehyde with a ketone such as acetone or cyclopentanone leads to other light sensitive bisphenols [35]. Polyvinyl alcohol modified with a 4'-substituted-4-carboxychalcone via ester formation producing polyvinylloxycarbonylchalcone has also been prepared [37]. The sensitivity of these polymers to ultraviolet radiation was found to be much higher than that of polyvinyl cinnamate, this is apparently due to their absorption at considerably longer wavelengths.

Fig 2.13: Dimers Formed On Photocyclo-addition Of Chalcone Units



Photodimers of coumarins have been known since the work of Ciamician and Silber [38 and 39]. Photocrosslinkable polymers containing the coumarin group can be made by, for example, the replacement of some of the hydroxyl groups of Bisphenol A based polyhydroxyethers by coumarin functional ester units or coumarin substituted derivatives of polyvinyl butyryl [40 and 41]. Cyclo-addition results in the formation of four isomeric dimers, the product distribution of which is dependent on monomer concentration, reaction solvent and whether a triplet sensitiser is present [41]. The photosensitivity of the coumarin functional polymers seems to be proportional to the mole fraction of the light sensitive units present and can be enhanced by adding triplet sensitisers [42]. Imides of maleic and dimethylmaleic acid photodimerise to form corresponding cyclobutane derivatives [41 and 43].

Fig 2.14: Irradiation Of Coumarin a) In The Presence Of A Sensitiser And b) No Sensitiser

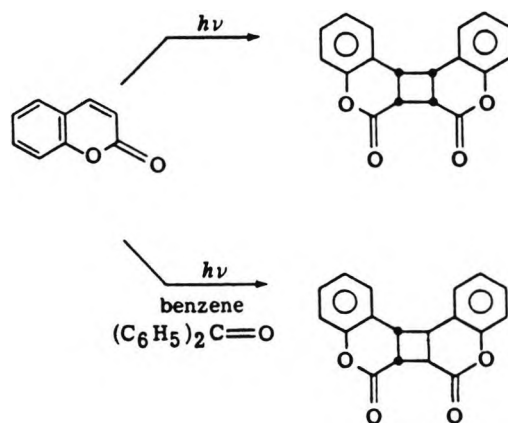

Schenck and Schryver have shown that imides and dimethylmaleimides are photochemically active [44, 45]. On irradiation with light of suitable wavelength they dimerise in a [2 + 2] photocyclo-addition mode to give a substituted cyclo-butane derivative. These groups have been incorporated into various polymers yielding highly sensitive photocrosslinkable polymer systems. Maleimide groups have been incorporated into polystyrene by a mild Friedel-Crafts reaction using N-chloromethyl-maleimide. Photodimerisation proceeds whether the systems are sensitised or irradiated directly. A large number of linear polymers have been prepared by UV irradiation of various bismaleimides. There are certain disadvantages of photocrosslinking via bismaleimides. These include low efficiency and the possible homopolymerisation of the bismaleimides either by photocyclo-addition or by free radical addition.

The [4+4] cyclo-addition of anthracene reactions have been described as proceeding from an excited singlet state which interacts with a ground state anthracene unit. The ease and extent of the photodimerisation reaction depends upon the nature of the substituent groups at the 9 and 10 positions with their steric effects being especially important [46]. Various linear polymers having pendant anthracene groups have been shown to crosslink, for example, hydrolysed polyvinyl acetate with anthracene-9-carboxaldehyde [47]. Tazuke and Hayashi have shown that the rate of polymerisation is greatly affected by polymer structure. A detailed study of anthryl modified polyesters and polyester urethanes revealed that

hydrogen bonding in the polyester urethanes restricted the movement of the anthryl groups. These polymers could therefore only be photocrosslinked at temperatures of 20°C or more greater than the glass transition temperature (T_g). Whereas the anthryl modified polyesters could undergo some photodimerisation at the T_g [48].

Fig 2.15: Photocrosslinkable Dimethylmaleimide Containing Polymers

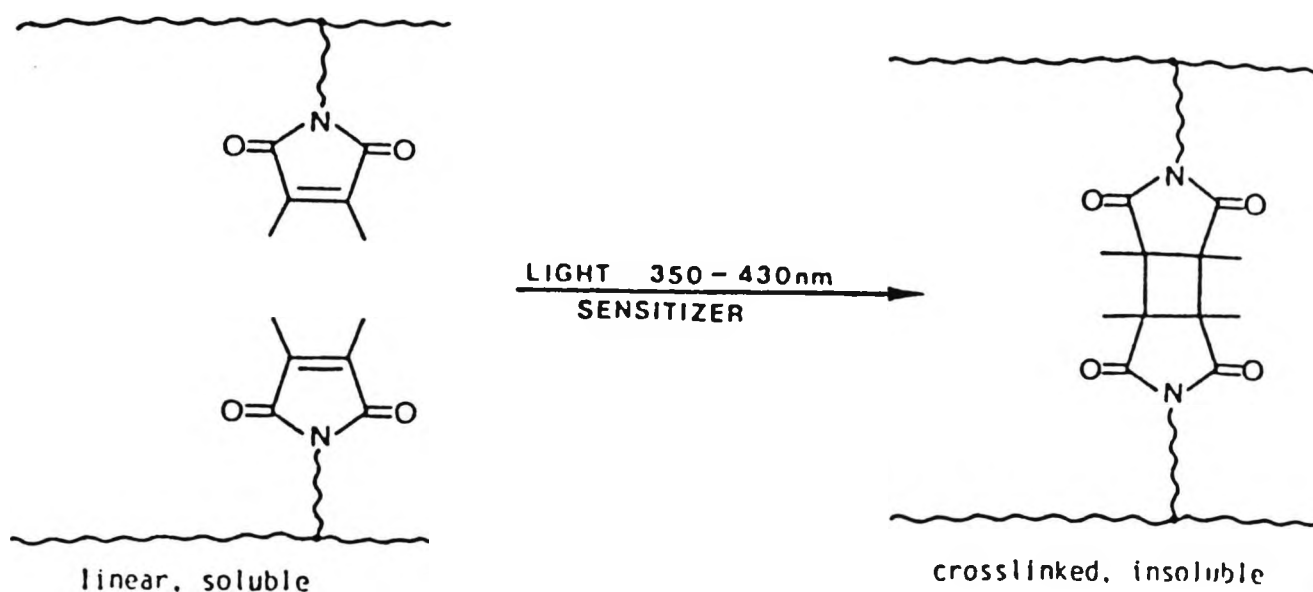

Conjugation with an aromatic ring increases the tendency of acyclic olefins to photodimerise. Polymers modified with a variety of stilbene derivatives undergo such dimerisations

readily even in the absence of added sensitizers [10]. The rate of photodimerisation is enhanced if electron donating groups are attached to the stilbene unit leading to more photosensitive polymers being developed [49]. The photodimerisation of 2-styrylpyridine and 5-ethyl-2-styrylpyridine, substituted in the 4' position by CH_3O , CH_3 , NO_2 and $(\text{CH}_3)_2\text{N}$ groups was studied by Williams et al [50, 51 and 52]. Stilbazolium groups can be introduced into polymers by reacting various polyvinyl pyridines with aldehydes. Williams and Borden described the synthesis and the properties of photosensitive polymers derived from polyvinyl alcohol [53]. The reaction sequence involved reacting the polyvinyl alcohol with benzene sulphonyl chloride or p-toluene sulphonyl chloride. The resulting polyvinylaryl sulphonates were then quaternised with an excess of picoline and then allowed to react with anisaldehyde or 2-furfuraldehyde to yield the light sensitive polymers. The polymers obtained from 2-furfuraldehyde had greater sensitivity but poorer storage stability than the polymer derived from anisaldehyde [54 and 55]. The absorption spectra of these stilbazolium modified polymers extends into the visible region. An example of such a polymer is derived from PVA by a reaction involving arylsulphonyl chloride, quaternisation with 4-picoline, and then reaction with anisaldehyde or furfural [47]. Hasegawa et al have shown that photopolymerisation of 4'-(alkoxy carbonyl)-2,5-distyrylpyrazine occurs via a [2+2] cyclo-addition reaction [56]. X-ray diffraction has shown that this is a head to tail reaction.

Polymers containing the natural base thymine undergo inter

and intramolecular photodimerisation [57]. The photodimerisation reaction of thymine modified polymers showed two characteristic features. Firstly, the reaction proceeds smoothly under the irradiation of deep UV light of about 270nm. Secondly, the reaction is reversible and photocission of the cyclobutane type dimer leads back to the original thymine bases by irradiating with UV light of about 250nm. These two features make thymine modified polymers suitable for use as positive or negative photoresists with high resolution.

Fig 2.16: Dimerisation Of Thymine

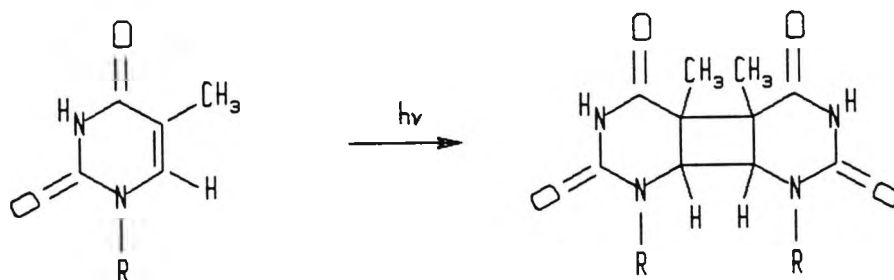

Photocyclo-addition reactions may involve either the singlet or triplet excited state of the chromophore. If a triplet sensitiser is present then cyclo-addition via the triplet excited states predominates (fig 2.17) [58-60].

Fig 2.17: Cyclo-addition Sequence

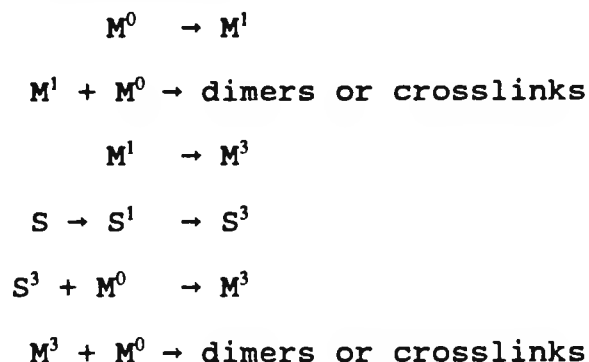

Mechanistically, these photocyclo-addition reactions are very similar and are best explained using polyvinyl cinnamate as an example. The reaction involves the activation of the cinnamate ester exocyclic c=c double bond. This excited chromophore then interacts with another cinnamate moiety in the ground state [61 and 62]. The result of the dimerisation of two units belonging to two different polymer chains is the formation of a cyclobutane ring between the chains. This reaction leads to a the rapid buildup of a three dimensional insoluble network (fig 2.12).

The quantum yield of unsensitised photocrosslinking is higher than that for the sensitised system. For a sensitised system to be efficient, the sensitiser must have a very high extinction coefficient at the wavelength of the light used for irradiation in order to absorb adequate light when

present at a relatively low concentration in the substrate. For a high population of sensitiser molecules to be maintained in the triplet state, the quantum yield of intersystem crossing (Φ_{isc}) must also be high. To ensure efficient energy transfer, the triplet lifetimes must be reasonably long ($\tau_t > 10^{-2}$) and the energy level of the triplet donor must be close to that of the acceptor.

For cinnamate and chalcone type chromophores it has been experimentally estimated that they have energy levels in the region of 50-57 Kcal/mol. The effect of some common photosensitisers on the photocrosslinking of polyvinyl cinnamate are shown in table 2.2 [58, 63 and 64].

Generally, in these photosensitive systems the initial photochemical reaction is trans-cis isomerisation leading to a photostationary state [40]. This is followed by dimerisation, the products being formed mainly from the trans isomer. Some dimers undergo cyclobutane cleavage at rates much slower than the dimerisation reaction. Whether dimerisation is the only process occurring leading to crosslinking has never been unambiguously demonstrated. One possibility for the production of free radicals is the photolytic decomposition of the cyclobutane dimer through α -bond cleavage to a phenyl ketone and cyclobutanyl free radicals. Such a process cannot be regarded as efficient because of the low extinction coefficient of the phenyl ketone chromophore ($n-\pi^*$ transition) at $\lambda > 300\text{nm}$. A simple cyclo-oligomerisation reaction can account for the production of oligomeric molecules, other than the dimer, with molecular

weights that are exact multiples of the molecular weight of the monomer. Thus, the biradical intermediate from the photocleavage of the cyclobutane dimer can react with a monomer to give a trimer. The trimer can in turn be photochemically cleaved to yield a new biradical which can add to a monomer to form a cyclic tetramer [65].

It has been suggested that for cinnamate, chalcone and coumarin modified polymers that a common excited species, namely the trans triplet, is responsible for both the isomerisation and the dimerisation reaction. Anthracene, stilbene and stilbazolium modified polymers crosslink via an excited singlet state interacting with a ground state monomer. Triplet state sensitizers inhibit dimerisation in the case of anthracene, stilbene and stilbazolium modified polymers as the triplet states do not undergo dimerisation.

Table 2.2: Effect Of Some Photosensitisers On The Photocrosslinking Of Polyvinyl Cinnamate [13]

Sensitiser	Cure Speed	E_T (Kcal/mol)	Triplet Lifetimes (s)	ϕ_{ISC}
none	1	50 - 55	-	0.10
naphthalene	3	61.0	2.300	0.11
benzophenone	20	68.5	0.001	1.00
4-nitroaniline	100	55.0	0.100	-
4-nitrobiphenyl	200	58.0	0.500	-
Michler's ketone	640	61	6.000	1.00

In all cases for efficient crosslinking to occur the polymer chains must intermingle freely so that the likelihood of two adjacent chromophores belonging to the same polymer chain is negligible, and intermolecular links will be formed almost exclusively. Inter- and intramolecular crosslinks can be distinguished by their effect on the insolubilisation of the polymer. Intermolecular crosslinks increase the molecular weight of the polymer whereas intramolecular links have no effect on the molecular weight. Reiser and Egerton, [66], investigated this phenomena using the three structurally similar polymers below :-

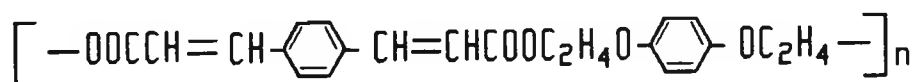
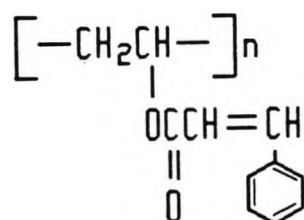

In all three cases the efficiency of intermolecular crosslinking and the overall quantum yield were found to be identical indicating a high degree of chain interpenetration.

Studies into the photocrosslinking of polyvinyl cinnamate have shown that the ϕ of photoreaction decreased from an initial value of 0.18 to 0 at about 50% conversion indicating that about half of the chromophores are in unreactive positions in the crosslinked material [67]. Similarly the ϕ of certain chalcone containing polymers dropped rapidly from an initial value of about 1 to a final value of 0.1 [13].

For all photosensitive materials which undergo crosslinking by [2+2] cyclo-addition reactions, it appears that the reactivities depend on both the backbone and sidechain structures. For crosslinks to occur reacting groups must meet and position themselves at appropriate distances with suitable concentration. Cohen and Schmidt have shown that in the photodimerisation of trans cinnamic acid the lattice exerts a dominant influence on the course of the reaction [68 - 70]. For efficient dimerisation to take place, the double bonds of the neighbouring cinnamate structures must lie within 3.6 -4.1 Å of each other. Segment mobility rather than segment concentration is of primary importance in determining the bimolecular reactivity in the solid state and in solution.

In order for a photosensitive polymer to be highly efficient intermolecular crosslinking must predominate over the intramolecular reaction. It has been shown that for a polymer mixture containing donor-type and acceptor-type cinnamoyl groups, predominantly cross dimerisation occurs. This reactant pre-ordering occurs due to donor-acceptor interactions between the functional cinnamoyl groups leading to excited energy transfer promoting intermolecular crosslinking. The photochemistry of the mixed cinnamate photodimerisation reaction reveals that the ratio of the cross dimer to the pure dimer depends on the multiplicity of the excited state; the ratio is about 5 in the triplet state and about 2 in the singlet state [71].

2.4 Excited Complexes And Their Role In Photocyclo-addition Reactions

The possible participation of excited complexes in photochemical was advanced long before such complexes were detected experimentally. Several reviews have been written on this topic [72 and 73]. The formation of intermolecular complexes in fluid solution requires that after excitation of one of the moieties, collision with the other group must occur within the lifetime of the excited state to form an encounter complex ($D^* A$) which may relax to form an excimer or an exciplex [74]. Hence the maximum rate constant for the process is determined by the rate for diffusion control in

the solvent used. Alternatively local high concentrations can be generated by:-

- (a) using micelles [75],
- (b) linking the two groups with a flexible chain [76],
- (c) using a quenching molecule with more than one quenching group, eg diamines [77],
- (d) using groups which hydrogen bond to each other, eg N-heterocycles with phenols in alkane solvents [78],
- (e) ground state charge transfer complexes

As early as 1928, [79], Waighert supposed that the photodimerisation of anthracene involved formation of intermediates which were later interpreted by Suzuki in 1950 as excited species [80]. In 1952, long before excimers were discovered Forster suggested the following mechanism for the dimerisation of anthracene (scheme 2.1).

Scheme 2.1: Dimerisation Of Anthracene

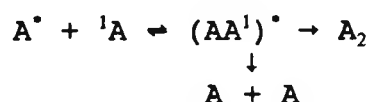

The term excimer is used to describe an electronically excited complex, formed between identical molecules or atoms, which has a definite stoichiometry but is unstable in the ground state. When the electronically excited molecular complex is formed between two different species, the term exciplex is used. If there is a degree of stability in the

ground state, the excited state is called an excited charge-transfer complex (electron donor-acceptor complex). The first excimer was identified by Forster and Kasper in 1954 when the fluorescence quantum yield of pyrene in non-polar solvents was found to decrease as the concentration was raised, while a new red shifted fluorescence band, lacking any vibrational structure, increased in intensity [81]. Leonhardt and Weller identified the first exciplex in 1963, the exciplex was formed as a result of the quenching of perylene fluorescence by *N,N*-dimethylaniline in non-polar solvents [82]. Evans in 1955 observed the first electron charge-transfer complex when iodine was dissolved in saturated hydrocarbons [83]. The fluorescence of these excited complexes show a broad structureless fluorescence spectra shifted to longer wavelengths. The excited complexes formed between two chromophores can be described by the following wave function [84]:-

$$\psi = C_1\phi(M_1^*M_2) + C_2\phi(M_1M_2^*) + C_3\phi(\overset{+}{M}_1\bar{M}_2) + C_4\phi(\bar{M}_1\overset{+}{M}_2) + C_5\phi(M_1M_2)$$

The stability of an electronically excited molecular complex derives in part from exciton resonance interactions involving delocalisation of excitation energy over both components and also from intracomplex charge transfer.

The weighting of (C_1 and C_2) relative to (C_3 and C_4) determines the relative contributions of exciton resonance and charge-transfer to stabilisation of the excited complex. The C_5 term will only be significant if the complex is stable in its ground state.

Excited complexes can decay by either radiative or non-radiative decay pathways described previously or they can lead to a number of species which are capable of participating in chemical reactions (scheme 2.2). Excited complexes which are not relaxed with respect to intrinsic and solvent parameters can relax to form equilibrium excited complexes. This relaxation is in competition with the other forms of radiative and non-radiative decay open to the non-relaxed excited complex. The failure of non-relaxed complexes to give equilibrium complexes is attributed to:

- (a) lack of binding energy:- non-radiative decay routes such as triplet formation can compete with formation of a stabilised or equilibrium complex [85]
- (b) product formation [86]

Scheme 2.2: Decay Processes Open To Excited States [72]

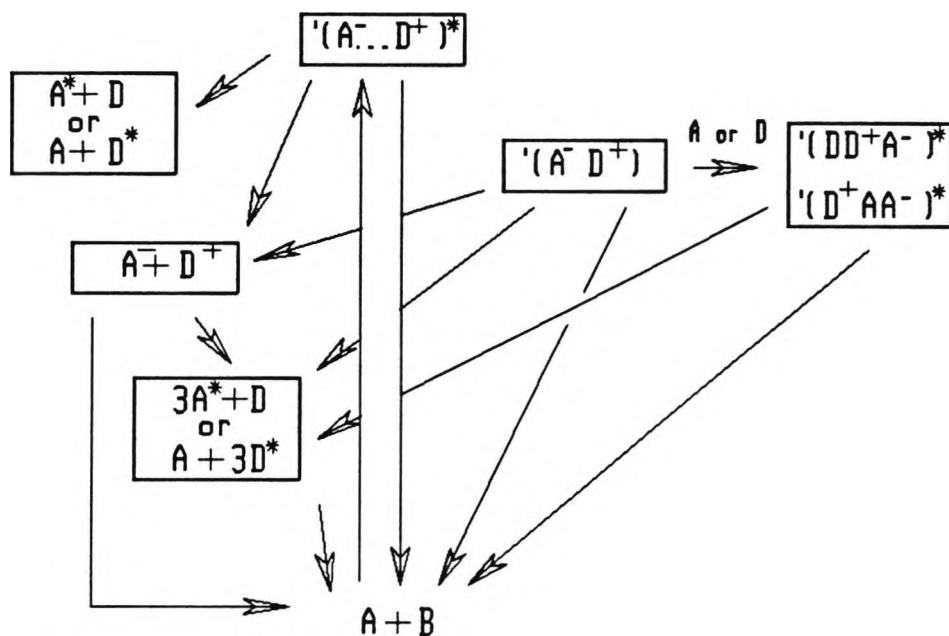

For an equilibrium complex to be formed the two groups or molecules have to reorientate with respect to each other. This process may be hindered by:-

- (a) unfavourable steric interactions due to substituent groups present with the participating molecules [87 and 88],
- (b) lack of conformational mobility [76 and 89],
- (c) rehybridisation of a group in the electron transfer reaction [88].

Reorganisation of solvent molecules is necessary for maximum stability of the initially created excited complex because electron distributions will have altered during excitation. The polarity of the solvents affects the relative contributions of polar and non-polar states to the wave function of the excited complex. Rehm and Weller's equation applies for cases where charge transfer is important [90].

The possible intermediacy of an "oriented π complex" in a bimolecular photochemical reaction was first suggested in 1964 by Corey in order to rationalise the regioselectivity of triplet enone-olefin cyclo-addition [91]. From that moment an abundance of photoaddition reactions were attributed to excited state complex formation. The following are selected examples of cycloaddition reactions via excimer, exciplex and excited state charge transfer intermediates where participation of these excited states have been indicated by photochemical and photophysical means.

Irradiation of phenanthrene in the presence of methyl cinnamate led to an efficient mixed cyclo-addition [92]. The quenching of the phenanthrene fluorescence and the quantum yield of adduct formation as a function of the cinnamate concentration indicates that the [2+2] cyclo-addition results from the reaction of singlet excited phenanthrene. As for most Woodward-Hoffman allowed cycloadditions, this reaction is highly stereospecific, ie the stereochemistry of the olefin is retained in the adducts. This high stereoselectivity of addition suggests the intermediacy of a

sandwich exciplex with strong π orbital overlap between the aromatic groups.

The degree of stereoselectivity depends on the extent of π overlap. For example [93], the stereoselective photoaddition of diphenylvinylene carbonate to dienes, which proceeds via exciplex intermediates, has various degrees of stereoselectivity and low regioselectivity. This suggests that several exciplex minima may be responsible for the different adducts. In this case phenyl-alkenyl π -orbital overlap does not seem to contribute as much to the exciplex stabilisation as the extended interaction in the phenyl-phenanthrene. Caldwell et al have shown that both exciplex emission and cyclo-addition are equally suppressed by an added quencher that intercepts the singlet exciplex [94].

Besides the effect of orbital overlap, the polarity of the exciplex appears to play a role in the stereochemistry of cyclo-addition. Yang has shown that, in the photoreaction of anthracene with dienes, less polar exciplexes favour the Woodward-Hoffman allowed $[4s+\pi 4s]$ cyclo-addition, whereas polar exciplexes yield the $[\pi 4s+\pi 2s]$ adducts [95].

Cyclo-addition reactions of aromatic anhydrides with benzocyclic olefins via excited complexes have the general features outlined for exciplex reactions such as stereochemistry of products, possibility of ISC and solvent effects [73 and 93]. Charge transfer excitation of dimethyl maleic anhydride and 1,1-dimethylindene in a non-polar solvent gives the oxetanes 1 and 2 in a 9:1 ratio (scheme

2.3). However when phthalic anhydride is used the oxetanes 3 and 4 are produced in a 1:1 ratio (scheme 2.4). The reaction of naphthalene yields only one sterically hindered oxetane (scheme 2.5). This indicates that the extent of π -orbital overlap strongly affects the stereochemistry of the cycloadducts. Increasing the degree of π -orbital interaction will increase the proportion of product derived from such a complex with a sandwich configuration in spite of steric hinderance. The lack of formation of any oxetane in the corresponding triplet sensitised reactions indicates that these products are formed from the singlet excited complex.

Solvent polarity also plays an important role in reactions via excited complexes. In non-polar media the primary photoadduct of the excitation of maleic anhydride/benzene complex is :-

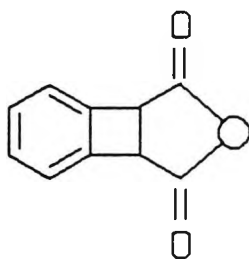

However, in the presence of trifluoroacetic acid the following substitution product is formed :-

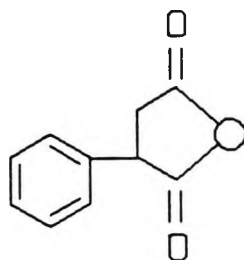

It is conceivable that CF_3COOH , especially at high concentrations, can alter the course of reactions of the excited complex by promoting radical ion formation.

The reaction of alkenes with benzene have been heavily investigated [96 - 98]. As a result some general rules have been formulated. The formation of 1,2 and 1,4-cyclo-addition products is found to occur when there is a substantial difference in ionisation potential between the alkene and benzene. When this condition prevails, the reaction is postulated as occurring via an exciplex derived from the excited singlet state of benzene. When relatively polar solvents are employed, exciplex fluorescence can be observed. These exciplexes probably have little binding energy in non-polar solvents where presumably exciton resonance is the stabilising factor. In more polar solvents, the solvent polarity will aid stabilisation via charge transfer. Reactions involving electron deficient alkenes is typified by the reaction of anisole and acrylonitrile. There is good evidence that this reaction involves electron transfer (scheme 2.6).

Scheme 2.3: Cyclo-addition Of Dimethyl Maleic Anhydride With 1,1-Dimethylindene

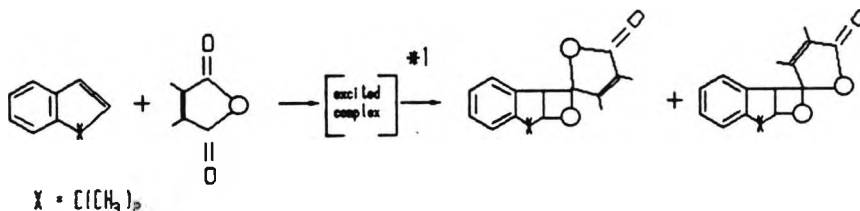

Scheme 2.4: Cyclo-addition Of Phthalic Anhydride With 1,1-Dimethylindene

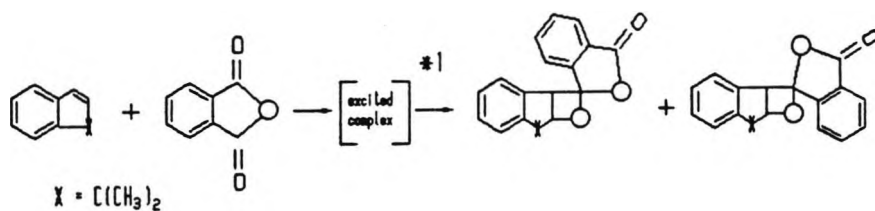

Scheme 2.5: Cyclo-addition Of Naphthalic Anhydride With 1,1-Dimethylindene

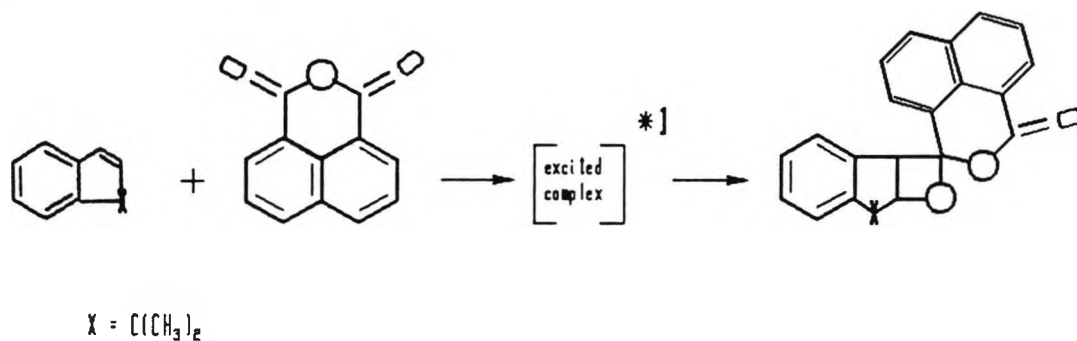

Scheme 2.6: Reaction Of Anisole And Acrylonitrile

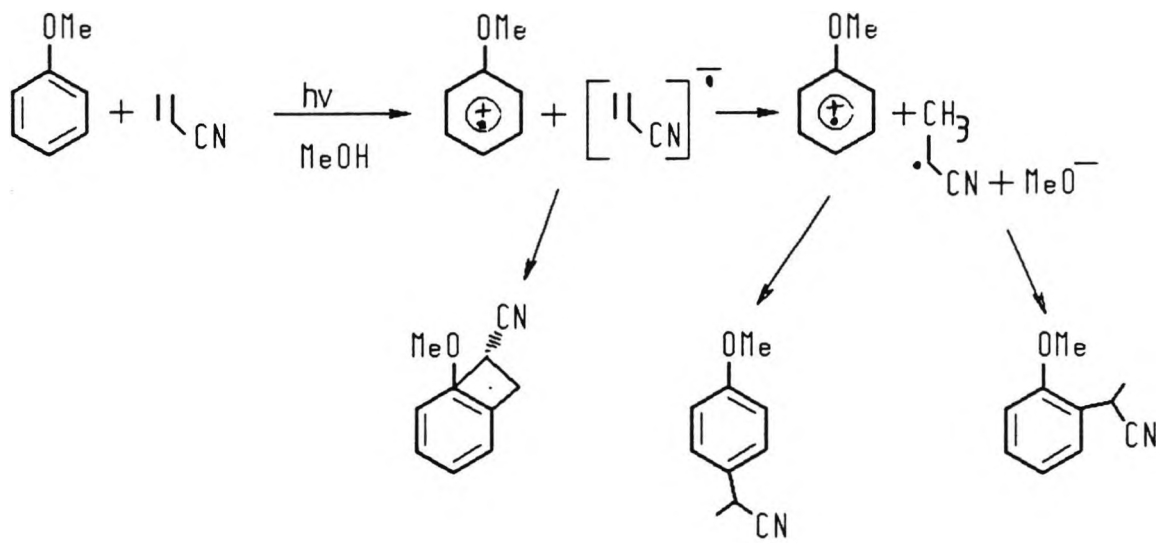

2.5 References

1. J.D. Coyle, "Introduction to organic photochemistry," John Wiley and Sons, 1989.
2. O.L. Chapman, "Organic photochemistry, vol 1," Dekker Edward and Arnold, 1967.
3. G.S. Cox, "Photochemistry and organic synthesis," Springer-Verlag, 1985.
4. K.K. Rohatqi-Mukherjee, "Fundamentals of photochemistry," Wiley Eastern, 1978.
5. A. Jablonski, Nature, 131, 839 (1933)
6. J.M. Coxon and B. Halton, "Organic photochemistry," Cambridge University Press, 1974.
7. R.B. Woodward and R. Hoffman, J. Amer. Chem. Soc., 87, 395, 2046, 4585, 2511 (1965)
8. R.B. Woodward and R. Hoffman, Accts. Chem. Res., 1, 17 (1968)
9. W.L. Dilling, Chem. Rev., 83, 1 (1983)
10. A. Schonberg, "Preparative organic photochemistry," Springer-Verlag, chapter 8,
11. A. Mustafa, Chem. Rev., 51, 1 (1952)
12. G.A. Delzene, Eur. Polym. Journal-Suppl., 55 (1969)
13. G.E. Green, P.B. Stark and S.A. Zahir, J. Macro. Sci - Revs. Macro. Chem., C21 (2), 187 (1982)
14. J. Fritzsche, Z. Angew. Chem., 10, 290 (1897)
15. Eastman Kodak Co., British Patent, 813,604 (1959)
16. Harris Intetype Co., British Patent, 1,112,277 (1968)
17. M. Remmas and J.C. Siutif, Makromol. Chem., 191, 6, 1277 (1990)
18. M. Shirai, M. Kwahara and M. Tanakai, J. Polym. Sci., Part A: Polymer Chemistry, 28, 2563 (1990)
19. S. Watanabe and K. Ichimura, J. Polym. Sci., Polym. Chem. Ed., 20, 3261 (1982)
20. A. Lin and A. Reiser, Macromolecules, 22, 3898 (1989)
21. J. Paczkowski, Macromolecules, 24, 2172 (1991)
22. Y. Schindo, T. Sugimura, K. Horie and I. Mita, Eur. Polym. J., 22, 11, 859 (1986)

23. M. Tsuda, J. Polym. Sci: Part A, 7, 259 (1969)
24. H. Tanaka and E. Otomegana, J. Polym. Sci., Polym. Chem. Ed., 12, 1125 (1974)
25. C.W. Leubner and C.C.
26. H. Tanaka and Y Sato, J. Polym. Sci., Polym. Chem. Ed., 10, 3279 (1972)
27. U. Ghosh and T. Misra, J. Polym. Sci., Polym. Chem., 26, 1681 (1988)
28. Eastman Kodak Co., US Patents 2,716,097; 2,716,102 and 2,716,103 (1951)
29. Eastman Kodak Co., US Patent 2,828,084 (1958)
30. Farbenfab. Bayer, French Patent, 168,217 (1955)
31. Eastman Kodak Co., US Patent, 2,708,665 (1951)
32. S.P. Panda, J. Appl. Polym. Sci., 18, 2317 (1974)
33. S.P. Panda, J. Polym. Sci., Polym. Chem. Ed., 13, 1757 (1975)
34. S.P. Panda, J. Polym. Sci., Polym. Chem. Ed., 13, 259 (1975)
35. S.P. Panda, Indian J. Technology, 9, 387 (1971)
36. D.G. Borden, J. Appl. Polym. Sci., 23, 239 (1979)
37. S. Watanabe, S Harashima, N Tsukada, J. Polym. Sci., Polymer Chemistry, 24, 1227 (1986)
38. G. Ciamician and P. Silber, Ber., 35, 4129 (1902)
39. G. Ciamician and P. Silber, Ber., 36, 4266 (1903)
40. S.A. Zahir, J. Appl. Polym. Sci., 23, 1355 (1979)
41. S. Farid et al, Chem. Ber., 99, 625 (1966)
42. G.A. Delzene and U.L. Laridon, Ind. Chim. Belg., 32, 373 (1967)
43. D. Bryce-Smith, G.J. Bullen, N.H. Clark, B.E. Connet and A.Gilbert, J. Chem. Soc., C, 167 (1966)
44. G.O. Schenck, W. Hartman, S.P. Mannsfeld, W. Metzner, C.H. Krauch, Chem. Ber., 5, 1642 (1962)
45. F.C. de Schryver, N Boens, G Smets, J. Polym. Sci., Part A-1, 10, 1687 (1972)
46. J.S. Hargreaves, J. Polym. Sci., Polym. Chem., 27, 203 (1989)

47. G.A Schroter and P Riegger, *Kunststoffe*, 44, 278 (1958)
48. S.A. Zahir, *J. Appl. Polym. Sci.*, 23, 1355 (1979)
49. F.A. Stuber, H. Ulrich, D.V. Rao and A.A.R. Sayigh, *J. Appl. Polym. Sci.*, 13, 2247 (1969)
50. J.L.R. Williams, J.M. Carlson, R.E. Adel and G.A. Reynolds, *Can. J. Chem.*, 43, 1345 (1965)
51. J.L.R. Williams, J.M. Carlson, G.A. Reynolds and R.E. Adel, *J. Org. Chem.*, 28, 1317 (1963)
52. J.L.R. Williams, S.K. Webster and J.A. Van Allan, *J. Org. Chem.*, 26, 4893 (1961)
53. J.L.R. Williams and D.G. Borden, *Makromol. Chem.*, 73, 203 (1964)
54. G.A. Delzene, *J. Radiat. Curing*, 6, 2 (1979)
55. G.A. Delzene, *Eur. Polym. J., Suppl.*, 55 (1969)
56. M. Hasegawa, T. Katsumata, Y. Ito and K. Saigo, *Macromolecules*, 21, 3134 (1988)
57. K. Takemoto and Y. Inaki, *J. Macromol. Sci.- Chem.*, A25, 757 (1988)
58. W.M. Moreau, *Polym. Prepr., Am. Chem. Soc.*, 10 (1), 362 (1969)
59. H.G. Curme, C.C. Natale and B.J. Kelly, *J. Phys. Chem.*, 71, 767 (1967)
60. K. Nakamura and S. Kikuchi, *Bull. Chem. Soc. Jpn.*, 41, 1977 (1968)
61. L.M. Minsk, J.G. Smith, WP Van Deusen and JF Wright, *J. Appl. Polym. Sci.*, 22, 6, 302 (1959)
62. M. Tsuda, *J. Polym. Sci: Part A*, 2, 2907 (1964)
63. S. Farid, P.A. Martie, R.C. Daly, P.R. Thomson, D.P. Specht, S.E. Hartman and J.L.R. Williams, *Pure Appl. Chem.*, 51, 241 (1979)
64. J.L.R. Williams, S.Y. Farid, J.C. Doty, R.C. Daly, D.P. Specht, R. Seartee, D.G. Borden and P.A. Martic, *Pure Appl. Chem.*, 49, 523 (1977)
65. H. Takahashi, M. Sakuragi and M. Hasegawa, *J. Polym. Sci., B*, 9, 685 (1971)
66. A. Reiser and P.L. Egerton, *Macromolecules*, 12, 144 (1979)
67. A. Reiser and P.L. Egerton, *Photogr. Sci. Eng.*, 23, 144 (1979)

68. M.D. Cohen, G.M.J. Schmidt and F.I. Sonntag, *J. Chem. Soc.*, 2000 (1964)
69. G.M.J. Schmidt, *J. Chem. Soc.*, 2014 (1964)
70. J. Bregman, K. Osaki, G.M.J. Schmidt and F.I. Sonntag, *J. Chem. Soc.*, 202 (1964)
71. J. Paczkowski, M. Toozek, F. Scigalski, D. Cwiklinska and M. Sierodca, *J. Polym. Sci., Polym. Chem.*, 27, 2647 (1989)
72. J.G. Calvert and J.N. Pitts Jr., "Photochemistry", John Wiley and Sons, 1966
73. M.G. Kuzmin and L.V. Soboleva, *Prog. Reaction Kinetics*, 14, 157 (1986)
74. R.S. Davidson, "Advances in physical organic chemistry", vol. 19 (Eds. V. Gold and D. Bethel), Acad. Press, 1 (1983)
75. N.J. Turro, M. Gratzel and A.M. Braun, *Angew. Chem. Int. Ed.*, 19, 675 (1980)
76. F.C. de Schryver, N. Boens and J. Put, *Adv. Photochem.*, 10, 359 (1977)
77. R.A. Beecroft, R.S. Davidson and T.P. Whelan, *J.C.S. Chem. Comm.*, 911 (1979)
78. S. Yamamoto, *J. Photochem.*, 5, 469 (1976)
79. T. Forster, "The Exciplex", (Eds. M. Gordon and W.R. Ware), Acad. Press, N.Y. (1975)
81. T. Forster and K. Kasper, *Z. Phys. Chem.*, 1, 275 (1954)
82. H. Leonhardt and A. Weller, *Ber., Bunsenges Phys. Chem.*, 67, 791 (1963)
83. D.F. Evans, *J. Chem. Phys.*, 23, 1424 (1955)
84. N. Mataga and M.O. Holenghi, "Molecular Association, vol 2", (Ed. R. Forster), Acad. Press,
85. R.S. Davidson, R. Bonneau, J. Joussot-Dubient and K.R. Tretheway, *Chem. Phys. Letts.*, 74, 318 (1980)
86. N.C. Yang and J Libman, *J. Amer. Chem. Soc.*, 95, 5783 (1973)
87. K.A. Zachariasse, W. Kuhnle and A. Weller, *Chem. Phys. Letts.*, 59, 375 (1978)
88. F. Meeus, M. Van der Auweraer and F.C. de Schryver, *J. Amer Chem. Soc.*, 102, 4017 (1980)

89. H. Bouas-Laurent, A. Castellan and J.D. Desvergne, *Pure Appl. Chem.*, 52, 2633 (1980)
90. D. Rehm and A. Weller, *Israel J. Chem.*, 8, 259 (1970)
91. E.J. Corey, J.D. Bass, R. Le Mahien and R.B. Mitra, *J. Amer. Chem. Soc.*, 56, 5520 (1964)
92. J.L.R. Williams, S.Y. Farid, J.C. Doty, R.C. Daly, D.P. Specht, R. Searle, D.G. Borden, H.J. Chang and P.A. Martic, *Pure Appl. Chem.*, 49, 523 (1977)
93. S.L. Mattes and S. Farid, *Acc. Chem. Res.*, 15, 80 (1982)
94. P. Caldwell, *J. Amer. Chem. Soc.*, 100, 2857 (1978)
95. P. Yang, *J. Amer. Chem. Soc.*, 97, 5004 (1975)
96. D. Bryce-Smith, *J. Chem. Soc., Chem. Comm.*, 112 (1980)
97. D. Bryce-Smith, *J. Chem. Soc., Perkin 1*, 55 (1980)
98. A. Gilbert, *Pure Appl. Chem.*, 52, 2669 (1980)

CHAPTER 3

Photocrosslinking Of PVA Modified With Pendant Styryl Pyridinium Groups

3.1 Objective

The literature states that styrylpyridinium derivatives exhibit excimeric fluorescence in both the solid state and monolayer assemblies [1]. This poses the question as to whether excimer formation plays a part in the cyclo-addition reaction. These modified films are remarkably photosensitive with irradiation increasing the extent of crosslinking [2]. This leads us to question whether crosslinking involves [2+2] cyclo-addition or whether there is photostimulated nucleophilic attack by OH groups of the PVA upon the double bond. Evidence for the latter reaction comes from the finding that irradiation of compounds such as styrylpyridines and quaternary salts of dipyridylethylenes in alcoholic solvent leads to nucleophilic addition to the double bond by the alcohol [3, 4]. A mechanistic study of the photocrosslinking of PVA films modified by styryl pyridinium groups should provide us the evidence to answer the above questions.

Also, it has been shown that 4-SbQ modified PVA is ten times faster at crosslinking than the 2-SbQ modified PVA using the conventional Gray scale method for evaluating sensitivity [2,]. A detailed spectral comparison of 2- and 4-SbQ modified PVA films over a range of concentrations would give us some

insight into the reason for this. Thus providing us with some criterion for photosensitivity.

3.2 Introduction

In the forties and fifties Eastman Kodak [6, 7] worked on photographic processes using light sensitive polymeric quaternary salts to produce light sensitive polymers which could be irradiated to insolubilise the polymer in the exposed area, allowing the unexposed polymer to be dissolved away leaving a relief image. Quaternary polymers formed from the reaction of poly-2-vinyl pyridine with methyl-p-toluene sulphonate, poly-4-vinyl pyridine with styrene bromohydrin showed low sensitivity with very limited value in the photographic process. Williams discovered that polymeric quaternary ammonium salts obtained by the reaction of polyvinyl sulphonates with styrylpyridine and styrylpyridine derivatives possess good sensitivity [7, 8]. The light sensitive quaternary ammonium salts have the general structures:-

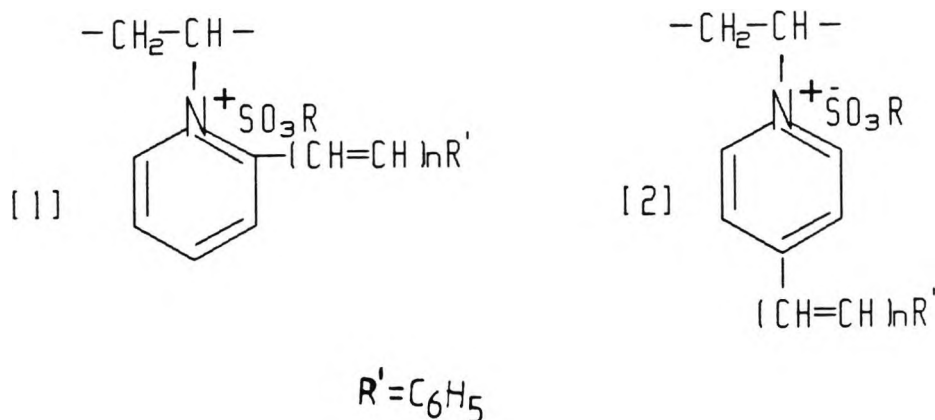

Ichimura has developed a new type of water soluble photosensitive resin [9-14]. These resins are polyvinyl alcohol possessing a styryl pyridinium or a styrylquinolinium residue as a photofunctional group illustrated by the following general structures:-

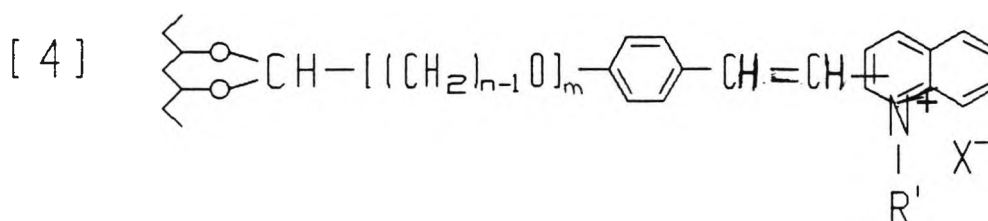
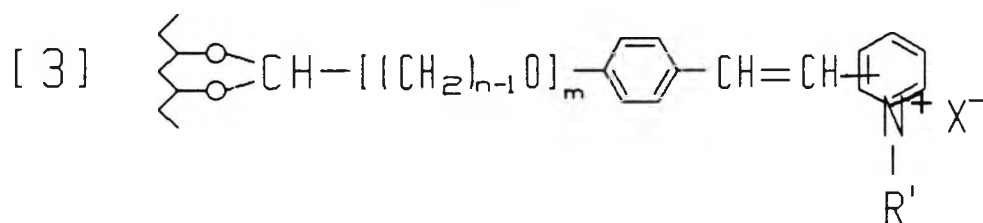

The resins are characterised by sensitivity, even with a low content of styrylpyridinium or styrylquinolinium, which is much higher than that of a conventional photoresist [15-17]. According to the inventor, the reason is attributed to the association of styrylpyridinium and styrylquinolinium groups in the polymer matrix. Another distinctive characteristic is its excellent storage stability.

3.2.1 Synthesis Of Styrylpyridines

There are various preparative methods for the synthesis of 2- and 4-styrylpyridines each differing in convenience, yield and isomer configuration (table 3.1) [18]. Styrylpyridine methiodides were prepared by Philips, method 1, using piperidine as a catalyst. A trans configuration was assigned

to the styrylpyridine methiodides on the basis of the spectroscopic work of Horwitz [19, 20].

Shaw and Wagstaff, method 2, refluxed picoline and benzaldehyde using acetic anhydride as a condensing agent for anything up to 18 hours to produce styrylpyridines [21]. Again only the trans configuration was present. The formation of the stilbazoles appears to proceed as in scheme 3.1. In all cases (b) proceeds rapidly compared with the net rate of the stilbazoles in acetic anhydride, so that stage (a) is the rate determining step.

Scheme 3.1: Condensation Of Methylpyridines And Benzaldehyde

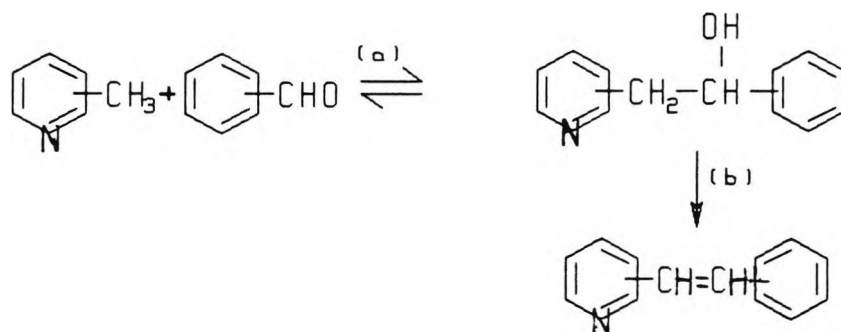

Styrylpyridine bases can also be prepared from benzaldehyde and picoline derivatives at 200°C using zinc chloride as the catalyst (method 3). This method produced only the trans form [22].

A novel method reported by Trippett employing an ylide intermediate has been used to synthesise 2- and 4-styryl pyridines [23].

Scheme 3.2: Styrylpyridine Synthesis Via An Ylide Intermediate

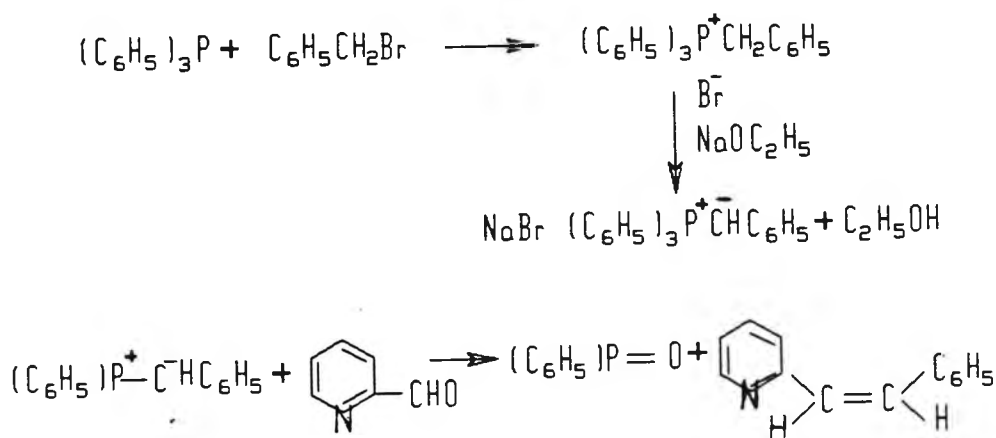

This fourth preparative method leads to a mixture of cis- and trans-stilbene.

Table 3.1: Physical Constants And Yields Of 2- Or 4- Styryl pyridine [18]

	λ_{max} (nm)	$\epsilon \times 10^{-3}$	% yield			
	trans form	trans form	1	2	3	4
2-Styryl pyridine	309	25.0	72.5	25	76	25 cis/9 trans
4-Styryl pyridine	307	33.3	38	60	20	42 cis

The first step of method 1-3 is an addition reaction leading to an intermediate alcohol (scheme 3.1). High pressure liquid chromatograms of the reaction mixture at different times show

that there is a stationary state of the intermediate alcohol where the concentration of 1-phenyl-2-(2-pyridyl)ethanol < 2 weight %. In the presence of an acidic catalyst the dehydration of the alcohol is very rapid; it is slower in basic medium [24].

All the styrylpyridinium salts used in this work were prepared by the synthetic route described by Ichimura, this is described in Chapter 3 section 3.3.1.

3.2.2 Preparation Of Modified PVA

The introduction of styrylpyridinium photosensitive groups onto PVA is accomplished by acid catalysed acetalisation of PVA with an aldehyde modified styrylpyridinium salts for example, 1-methyl- 2 or 4 -[2-(4-formylphenyl)ethenyl] pyridinium methosulphate (scheme 3.3) [25]. Hereafter 1-methyl- 2 or 4 -[2-(4-formylphenyl)ethenyl]pyridinium methosulphate will be referred to as 2- or 4-SbQ respectively.

Scheme 3.3: Acid Catalysed Acetalisation Of PVA

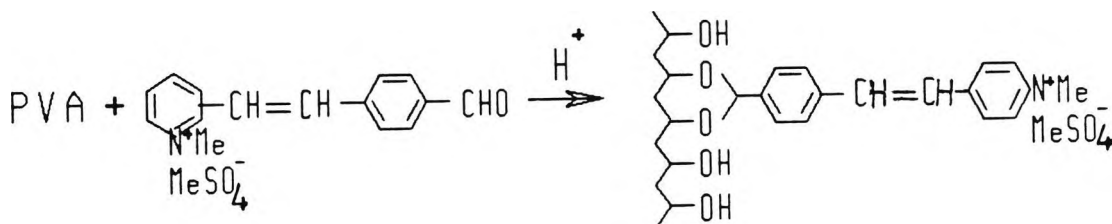

There are two methods for grafting these photosensitive moieties onto the backbone of PVA. Because of the high solubility of these salts in water, the first method proceeds in a homogeneous aqueous solution containing a catalytic amount of acid [15]. The critical mole % of the styrylpyridinium derivative which maintains the water solubility of the polymer depends on the nature of the acid catalyst and decreases approximately in the following order when these catalysts are used: phosphoric acid = hydrochloric acid > p-toluenesulphonic acid > sulphuric acid. When PVA is treated with 2 mole % of these photosensitive compounds in the presence of phosphoric acid at 60° for 5 hours the solution becomes very viscous and on the addition of more salt leads to gelation. The critical mole % of these salts is dependent on the nature of the compound. After acetalisation the reaction mixture still contains the acid catalyst and the unreacted pyridinium salt. The acid is detrimental for almost all applications and is removed by neutralisation with a base or absorption onto an ion exchange resin. The unreacted compound can also be eliminated by precipitating down the modified PVA with a water soluble organic solvent and redissolving.

The second method involves the acetalisation in the heterogeneous state [26]. The PVA is allowed to swell in an aqueous organic solvent, e.g. methanol, isopropanol or acetone, containing a catalytic amount of acid. The presence of water in the heterogeneous method is essential, but there is also a limit since the PVA particles become swollen and adhere to each other making the work-up procedure difficult.

The distribution of the photofunctional groups is affected by the mode of preparation yet the photosensitivity of PVA was not affected by the method of preparation.

3.2.3 Photochemistry Of Styrylpyridinium Groups

Styrylpyridinium compounds undergo photostimulated azaphenanthrene cyclisation as well as cis-trans isomerisation [24]. Absorption of light by a compound containing an ethylenic double bond can result in cis-trans isomerisation [27]. Direct irradiation of either isomer results in the formation of a photostationary state. Direct irradiation of solutions of either cis or trans-stilbene with light of 3130Å leads to photochemical steady-state consisting of about 93% cis-stilbene and 7% trans-stilbene [15, 28-30]. The high cis-isomer population at the steady-state reflects in part the large extinction coefficient of trans-stilbene ($\epsilon=16300$) compared to that of cis-stilbene ($\epsilon=2280$). It appears fairly general that, if one isomer of the cis-trans pair absorbs the incident radiation much more strongly than the other and if the relative quantum efficiencies for the cis-trans and trans-cis isomerisation do not differ enormously, the steady-state concentration of the isomer having the lower absorptivity will predominate. It has been shown that there is no common intermediate in cis-trans and trans-cis isomerisation, and that two triplet states are involved (scheme 3.4) [31].

Scheme 3.4: Electronic States Of Stilbene Trans-Cis Isomerisation

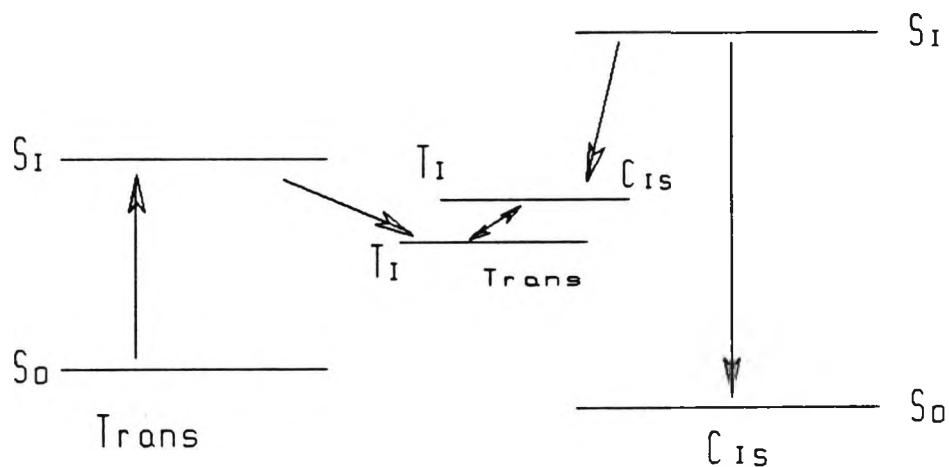

Scheme 3.5: Stilbene Trans-Cis Isomerisation, Followed By Photocyclisation To Generate Phenanthrene

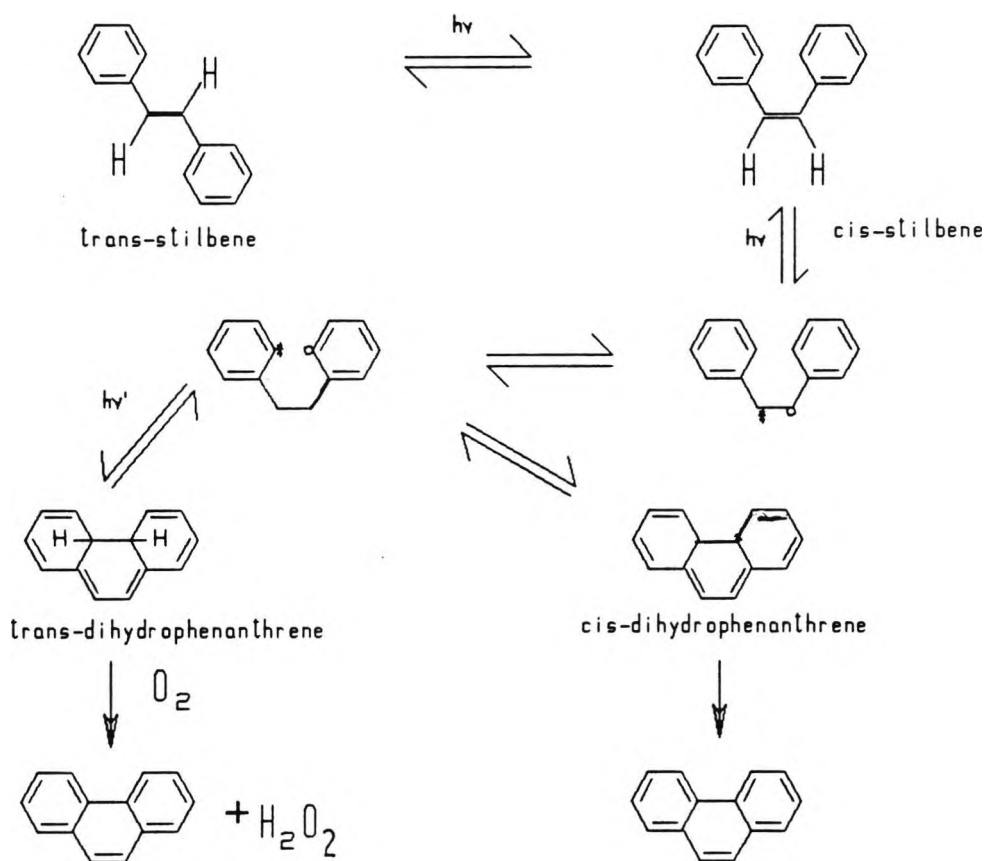

Isomerisation of olefinic compounds can be achieved by photosensitisation, the composition of the photostationary state depending on the triplet energy of the sensitiser [32].

The photochemical behaviour of styrylpyridines is similar to that of other N-heteroaromatics, in which radiationless deactivation of the singlet state is the major process. Rates of the various deactivation processes depend on the position of the nitrogen [24]. Like stilbene type molecules, styrylpyridines undergo direct and sensitised isomerisation. The principle means of deactivation for the lowest excited singlet state at room temperature is isomerisation. Isomerisation of the stilbazoles has been shown to be almost independent of the solvent used. Upon continued direct irradiation, considerably longer than to reach a photostationary state, phenanthrene derivatives can be detected. Research into sensitised isomerisation has shown that the triplet energies of the cis and trans stilbazole isomers are similar to those of the stilbenes [24]. The work of Whitten and McCall has also shown that the deactivation of singlet and triplet states of the stilbazoles includes radiationless decay processes which proceed by paths not involving cis-trans isomerisation. Enhanced radiationless processes have been observed in these azastilbenes [24]. El-sayed et al. predicted that ISC between $\pi-\pi^*$ states and $n-\pi^*$ states should proceed faster than crossing between states of the same type [33]. Although no evidence has been found for low-lying $n-\pi^*$ states in the stilbazoles, it seems probable that crossing occurs from a lowest $\pi-\pi^*$ singlet to an upper $n-\pi^*$ triplet in many of these compounds. Other studies have

shown that compounds which have either lowest $n-\pi^*$ states, or lowest $\pi-\pi^*$ states where $n-\pi^*-\pi-\pi^*$ mixing occurs, show enhanced rates of radiationless decay.

The oxidative photocyclisation of stilbene and its derivatives to yield phenanthrene derivatives via dihydrophenanthrene derivatives has been known for many years [34]. Photostimulated cyclisation proceeds directly from the cis isomer. It is believed that excited singlet states are involved. The main evidence rests on the fact that triplet photosensitisers are effective in producing isomerisation but that neither phenanthrenes, dihydrophenanthrenes or its derivatives are found (scheme 3.5).

Irradiation of PVA modified with styrylpyridinium salts, in the solid state, leads to [2+2] cyclo-addition products. Photoisomerisation is negligible in the solid state [35]. Dimerisation proceeds via an excited singlet state [2, 36-38]. This is due to the aggregation of the SbQ molecules as the concentration increases. It has been shown that the extent of dimerisation decreases with dilution, indicating that the dimerisation reaction is concentration dependent whereas cis-trans isomerisation is concentration independent. It has also been reported that, in the solid state, the styrylpyridinium salts exhibit excimeric emission. It has been suggested that these excimers play an intermediary role in the cyclo-addition reaction [1, 39, 40].

Analysis of the spectral change of thin films of PVA modified with styrylpyridinium salts shows a decrease in the absorption at the longest wavelengths upon irradiation with UV light, accompanied by a new band at 270nm (Fig 3.1). The new band at 270nm is attributed to the products of the intermolecular cyclobutane forming reaction of the styrylpyridinium group. Photo-induced cleavage of the ring resulted in the regeneration of the double bond. When irradiated films were exposed to light at 270nm, the absorption band at 345nm due to the conjugated double bond was gradually recovered. On examination of absorption spectra of thin films of PVA modified with 4-styrylpyridinium groups a weak absorbance as a shoulder around 370nm was noticed. This band was not observed in aqueous solutions. The new band corresponds to the aggregated state of the styrylpyridinium groups [2].

Fig 3.1: Analysis Of Thin Films OF PVA Modified With A 4-Styryl pyridinium Salt Upon Irradiation With UV Light

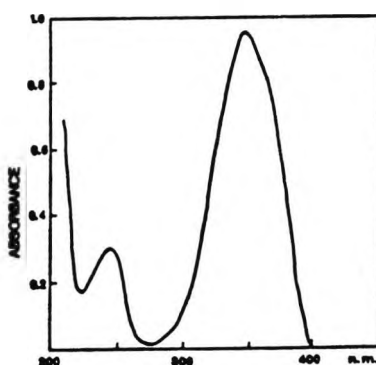

The dimerisation of modified PVA leads to an increase in the molecular weight of the polymer and eventually to insolubilisation. Due to efficient aggregation of SbQ

molecules, an extremely low content of the photofunctional groups is required on the PVA to bring about crosslinking. Thus the physical and chemical properties of the grafted PVA change very little compared to unreacted PVA [15].

3.2.4 Comparison Of The Rates Of Insolubilisation Of Modified PVA Films

The study of the photosensitivity of 2- or 4-SbQ modified PVA requires the development of an experimental technique for the evaluation of the response of these substances to light. First of all, the solutions to be studied were coated, twice on each side, onto 120 HDW white mesh stretched over a wooden frame. White mesh was used in all examples, as mesh treated with an anti-halation dye causes a reduction in the speed of crosslinking. When dry these screens are exposed in a Platemaker exposure unit using a square root of two Stouffer Step wedge as supplied by Du Pont-Howson [41].

A step wedge is a series of neutral density filters, with increasing optical density, usually fabricated on a polyester sheet with silver halide technology or with colloidal carbon. There are two basic step wedges used in industry: the 6th root of two and the square root of two. The optical density of each step increases such that if the exposure is doubled, the step held will increase by 6 units for the 6th root of two step wedge and only two units for the square root of two step wedge.

Stepwedges can be used to indicate the degree of polymerisation of the 2- and 4 SbQ-modified PVA films by comparing the step achieved for a particular exposure time. One problem associated with the step wedge is the developer dependency. The step passes only enough light under a particular step to polymerise the film to become insoluble in the developer. The modified PVA films are developed in a spray of cold water. The spray pressure, solution temperature, and duration of spray will also have an influence on the reading.

The light transmission of the stepwedge was calculated from optical density readings of each step of the step wedge by a Macbeth TD964 transition densitometer [42].

$$T = 1/10^D \times 100 \% \quad \text{Equation 3.1}$$

T = Light Transmission, D = Optical Density

The light transmission was calculated for the first sixteen steps of a twenty step Stouffer stepwedge (Table 3.2).

For exposure under similar conditions the higher the stepwedge reading the more insoluble the polymer and hence the faster the rate of crosslinking (Fig 3.2). For each increase of two on the stepwedge then the rate of crosslinking is doubled. Thus the stepwedge enables the required exposure to light to be calculated from a single exposure.

Fig 3.2: Diagram Of A Stepwedge And A Negative Image Of A Stepwedge

Stepwedge



Stepwedge Negative

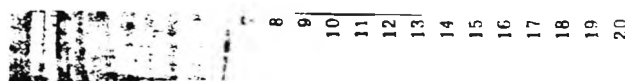

Table 3.2: Du Pont-Howson Souffer Stepwedge

STEP NUMBER	% LIGHT TRANSMISSION
0	100
2	50
3	35.7
4	25
5	17.8
6	12.5
7	8.9
8	6.2
9	4.5
10	3.1
11	2.23
12	1.65
13	1.11
14	0.83
15	0.56
16	0.41

3.3 Results And Discussion

3.3.1 Preparation Of Photosensitive Materials

Both 2- and 4-SbQ moieties were synthesised by two methods [15]. The first is the condensation of terephthalaldehyde with 2- or 4-picoline, in boiling acetic anhydride-acetic acid mixture. Quaternisation with dimethyl sulphate follows the condensation reaction. The second consists of quaternisation of 2- or 4-picoline, followed by condensation with terephthalaldehyde in methanol and a catalytic amount of piperidine (scheme 3.6).

Scheme 3.6: Synthesis of 2- Or 4- Styrylpyridinium Salts

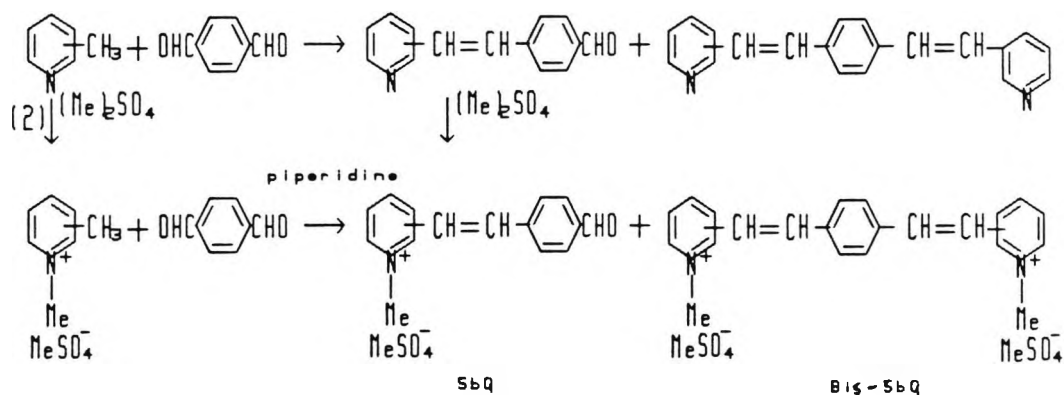

The major by-product of both these reaction routes is the diolefinic, 1,4-bis[4-(2- or 4-pyridyl)ethenyl]benzene, which is formed by the further condensation of 2- or 4-SbQ with picoline or the picolinium salt. The yield of the diolefinic compound can be minimized by using excess terephthaldehyde. Because terephthaldehyde reacts with the 2- or 4-picolinium salt at a faster rate than the 2- or 4-SbQ, it is not necessary to use a large excess of terephthaldehyde for selective monocondensation. The use of 1.5 molar equivalents of terephthaldehyde is sufficient for obtaining good yields of 2- or 4-SbQ, 60% and 80% yields respectively.

Photosensitive polymers were prepared by grafting 2- and 4-SbQ, at varying levels of concentration, onto the backbone of PVA. Modification was achieved by the homogeneous method with 2% H_3PO_4 at 60° for 5 hours, grafting occurred at greater than 90%.

3.3.2 Examination Of Model Compounds

Before investigating the modified PVA in thin films, model compounds were prepared and subsequently examined in aqueous solution. These model compounds, compounds 5 and 6, were synthesised in a similar manner as 2- or 4-SbQ.

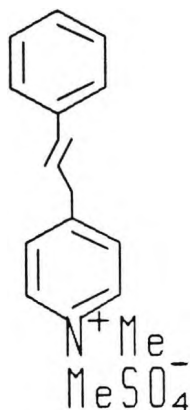

5

1 methyl-4-[2-(phenyl)ethenyl]
pyridinium methosulphate

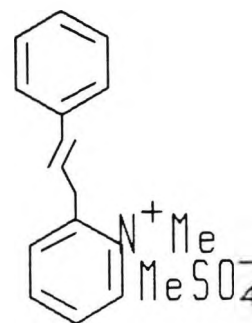

6

1 methyl-2-[2-(phenyl)ethenyl]
pyridinium methosulphate

Aqueous solutions of compounds 5 and 6 were prepared and their UV spectra obtained. As the concentration of these solutions increases there is a slight red shift of the λ_{max} in both cases (table 3.3). The fluorescence spectra of compounds 5 and 6 were also obtained and again slight red shifts were observed (fig 3.3 and 3.4). The red shift is more pronounced in compound 6. A known weight (0.5g and 1.5g) of each model compound was added to 100g of a 13% PVA aqueous solution (fig 3.5 and 3.6). Again increasing the concentration results in a red shift of the fluorescence maxima. The shift to longer wavelengths on increasing concentration indicates that even in solution there is some degree of aggregation of the molecules leading to what was believed to be excimeric emission. One point of interest is

that the 2 substituted styrylpyridinium salt (compound 6) shows a more pronounced shift to longer wavelengths indicating a greater degree of aggregation. This observation will be commented on in section 3.3.4.

Table 3.3: UV Absorption Maxima At Optical Density 0.1 And 0.2

	Compound 5	Compound 6
OD	λ_{max} (nm)	λ_{max} (nm)
0.1	338	331
0.2	341	334

Fig 3.3: Fluorescence of 1-Methyl-4-[2-(phenyl)ethenyl]pyridinium Methosulphate In Aqueous Solution At Optical Density 0.1 And 0.2. Irradiation At 340nm.

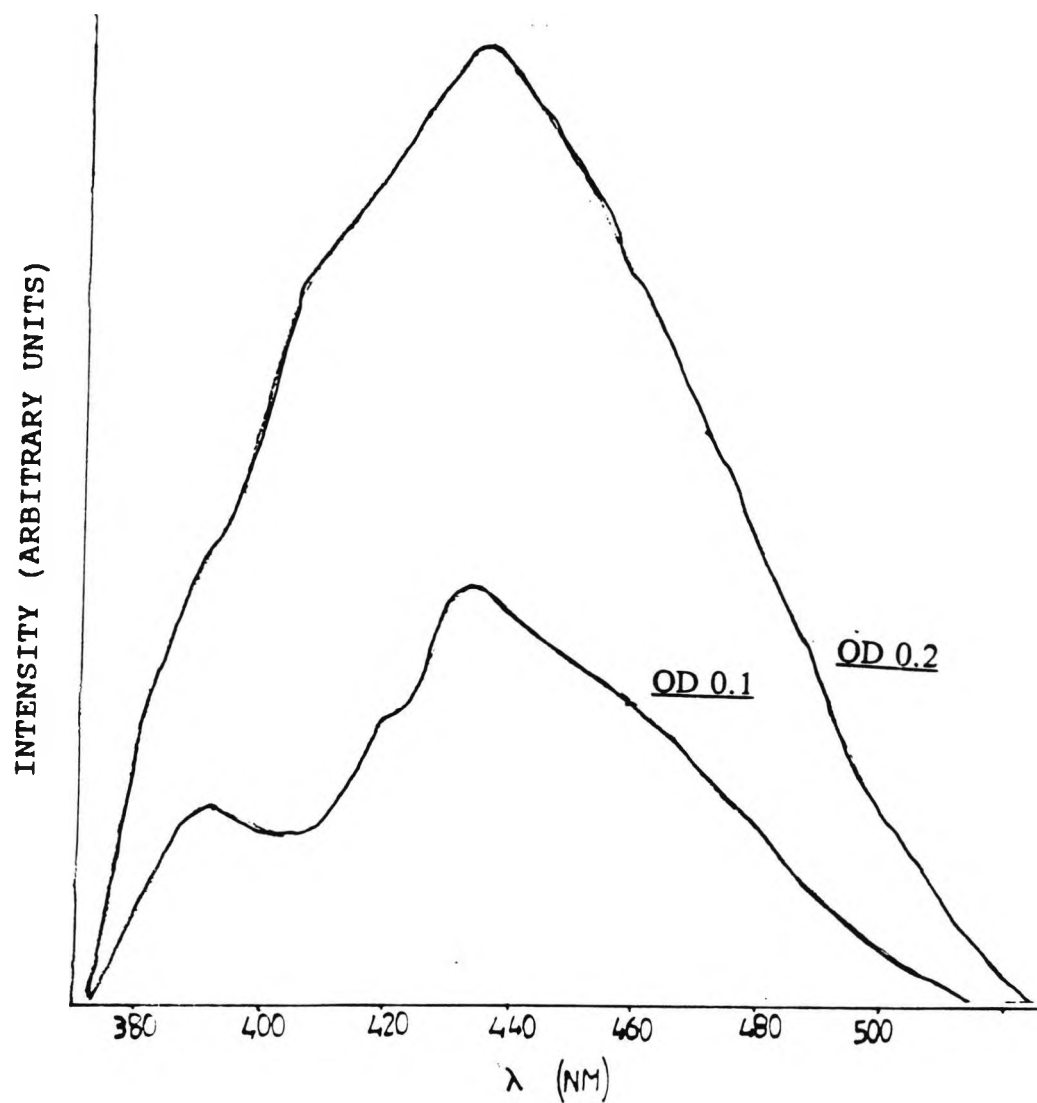

Fig 3.4: Fluorescence Of 1-Methyl-2-(2-(phenyl)ethenyl)pyridinium Methosulphate In Aqueous Solution At Optical Density 0.1 and 0.2. Irradiation at 340nm.

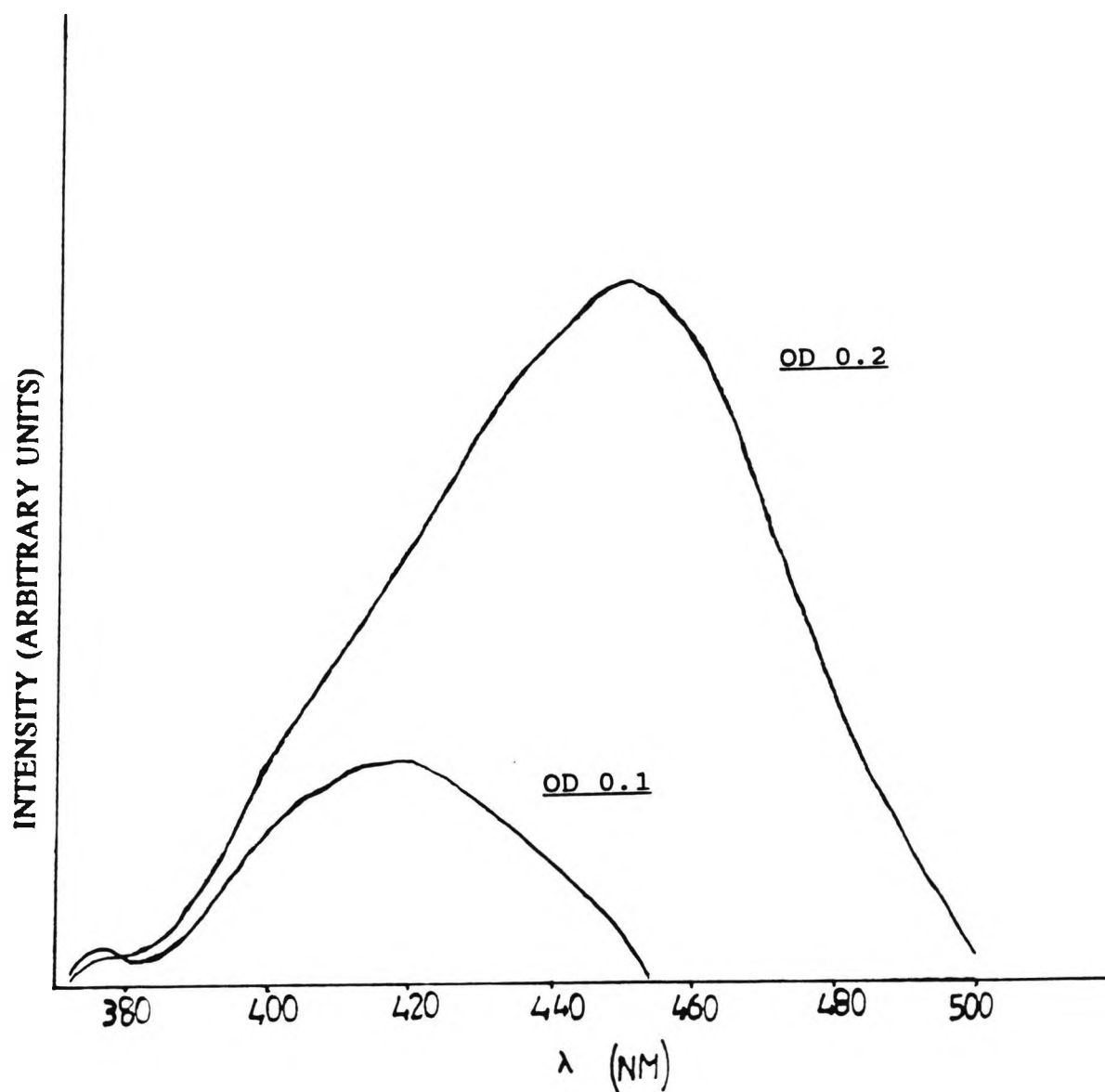

Fig 3.5: Fluorescence Of Xg Of Compound 5 In 100g Of PVA Solution. Irradiated At 340nm.

X = 0.5 or 1.5

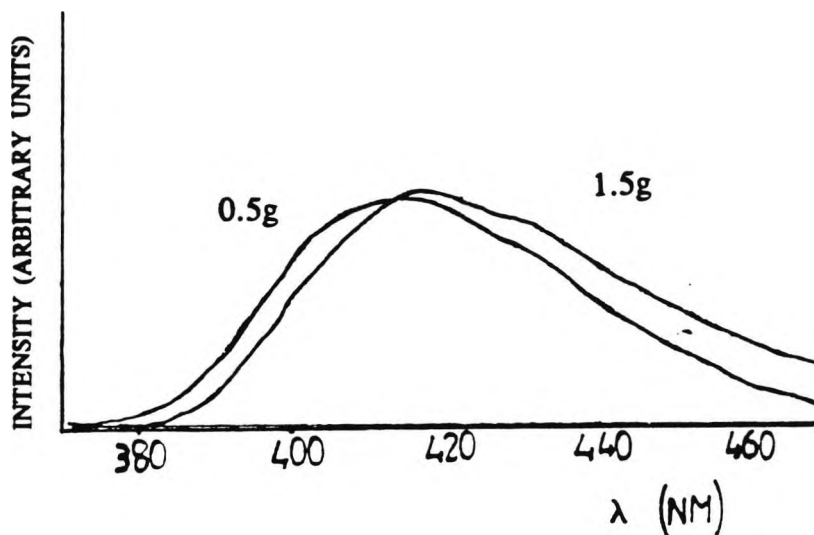
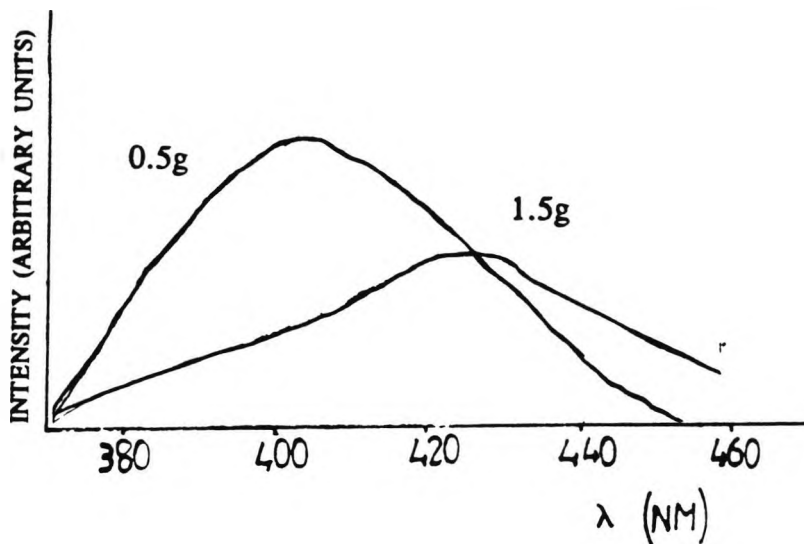

Fig 3.6: Fluorescence Of Xg OF Compound 6 In 100g Of PVA Solution. Irradiated at 340nm.

X = 0.5 or 1.5



3.3.3 A Mechanistic Study Of The Photocrosslinking Of PVA Films Modified With Pendant Styryl Pyridinium Groups [43]

The absorption spectrum (diffuse reflectance) of 4-Sbg modified PVA thin films (0.48 mole %) shows a maximum at 348nm similar to that observed for the same material in aqueous solution [44] (Fig 3.7).

Fig 3.7: Absorption Spectrum Of The Modified PVA Film

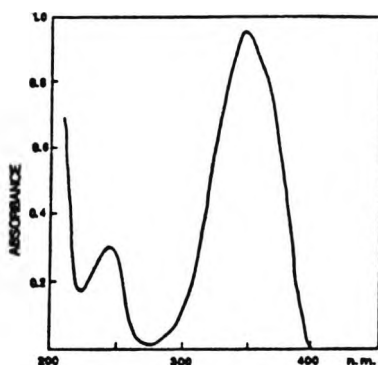

Although this technique fails to give unequivocal evidence for aggregation in the ground state, examination of the fluorescence spectra of the film shows that there is a high degree of aggregation since the spectra are dominated by an excimer emission band (max 450nm). In one case, the film was irradiated using a conventional UV cure apparatus and in the other it was irradiated inside the sample compartment of a fluorimeter using the excitation source (Fig 3.8 And 3.9). As it can be seen, in both cases , irradiation of the films leads to a reduction in the intensity of the excimer emission. Figure 3.8 shows an emission band at shorter wavelength (max 400-410nm) due to the paper support rather than the photosensitive PVA.

Fig 3.8: Fluorescence Spectra Of Films Irradiated Under UV Curing Conditions (12m/min)

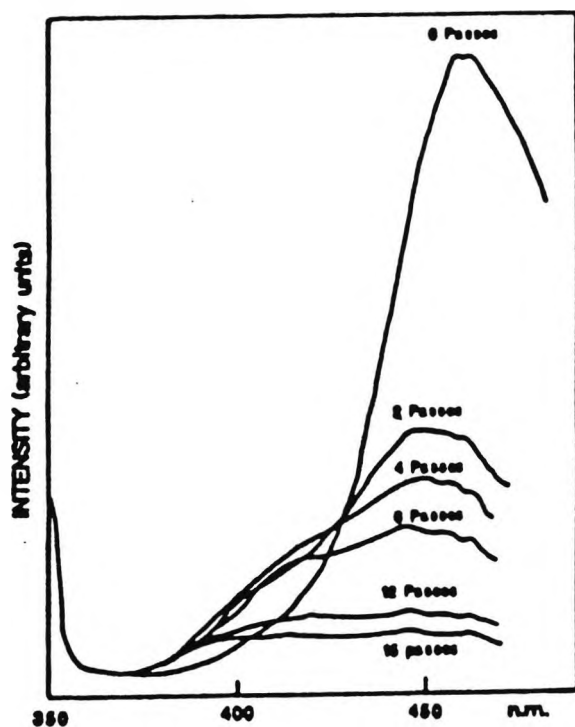
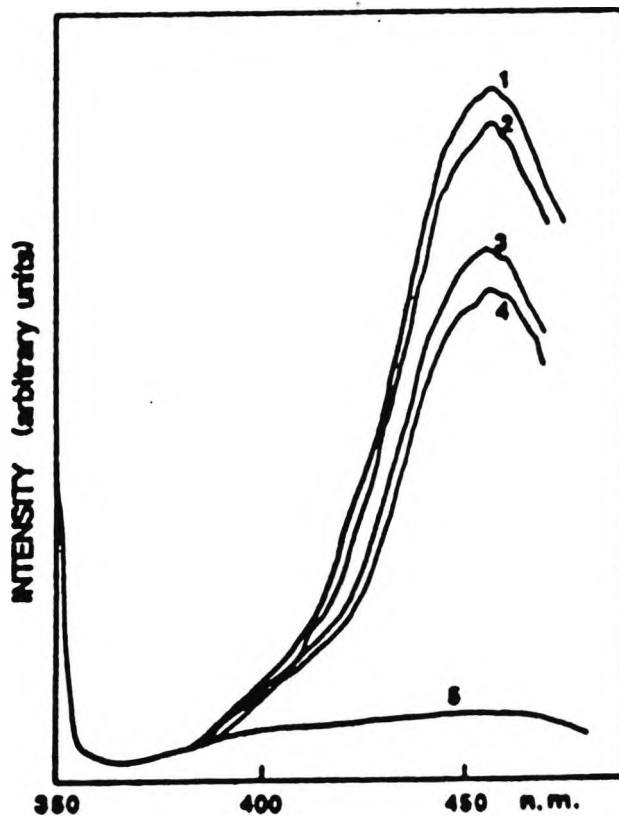
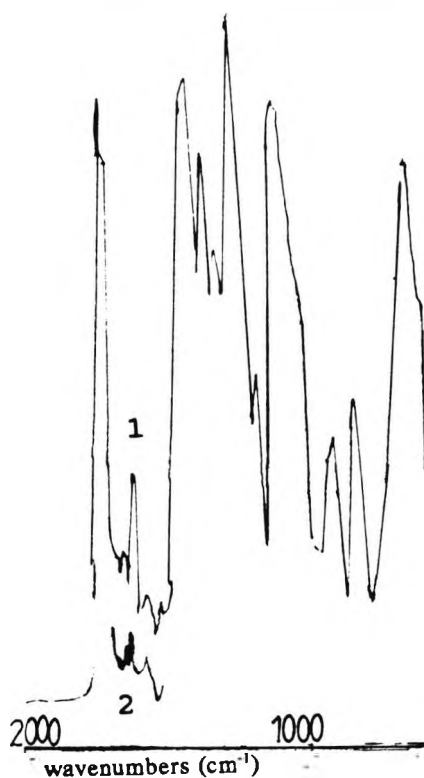

Fig 3.9: Fluorescence Spectra Of Films Irradiated In The Spectrafluorimeter (350nm). (1)-(5):-60,75,135,150 and 450 min. respectively.



The crosslinking of the modified PVA was followed by FT-IR spectroscopy (Fig 3.10). The intensity of the $c=c$ peak (1625cm^{-1}) was measured after successive passes under a conventional UV cure apparatus. This technique shows that the main crosslinking reaction occurs extremely rapidly. Even on prolonged irradiation there are still some styrylpyridinium groups remaining unreacted. The remaining groups are photochemically inactive. These moieties are either isolated, thereby unable to undergo dimerisation, or they are present as aggregates in which the groups are not correctly orientated for excimer formation and cyclodimerisation [23, 29, 45]. This photochemical inactivity suggests that little of the observed photoreactivity is due to nucleophilic attack by the OH groups of the PVA on the excited styrylpyridinium compound.

Fig 3.10: Diffuse Reflectance FT-IR Spectrum Of 4-SbQ Modified PVA: 1=0 passes; 2=15 passes.



Attempts were made to measure the fluorescence lifetime of the excimeric species using a fluorescence microscope. The illumination source was an argon ion laser (10 mW; 488nm); fluorescence emission could be seen but extensive photobleaching, i.e. photoreaction leading to the destruction of the styryl pyridinium group, was so fast that neither the fluorescence nor the fluorescence lifetime could be measured. For the latter purpose, the light beam from the laser was modulated using a pockel cell which delivered pulses having a duration of 6 nanoseconds.

3.3.4 Comparison Of 2- And 4-SbQ Modified PVA Films

The speed of insolubilisation, i.e. crosslinking of these photosensitive polymers over a range of concentrations was evaluated using a Stouffer stepwedge (Table 3.4).

Table 3.4: Stepwedge Values Of 2- And 4-SbQ Modified PVA On Irradiation (200 Light Units)

mole %	4-SbQ	2-SbQ
0.50	13	washed out
1.00	15	10/11
1.25	19	11/12
1.50	19	13/14
1.75	20	15
2.00	20	15

From table 3.4 it can be seen that at all levels of grafting the 4-SbQ modified PVA is very much faster than the 2-SbQ modified PVA. Table 3.5 indicates that the acetalisation process is equally efficient for both photosensitive materials i.e. equivalent amounts of SbQ are being incorporated onto the PVA.

The amount of 4-SbQ and 2-SbQ grafted onto the PVA backbone is measured by the precipitation of the modified PVA by the slow addition of solvent, e.g. acetone. The precipitated polymer is filtered, washed and dried. A known amount of polymer is dissolved in H₂O and the concentration of the photosensitive groups present are calculated via the Beer-Lambert Law (equation 3.2) [46].

$$A = C \times L \times \epsilon \quad \text{Equation 3.2}$$

[A is defined as the absorbance, C is the concentration (mol dm⁻³), L is the pathlength (cm) and ϵ is the molar extinction coefficient]

Table 3.5: % Grafting Of 2- Or 4-SbO Onto PVA

MOLE %	4-SbQ (% Grafted)	2-SbQ (% Grafted)
0.50	>90	>90
1.00	>90	>90
1.25	>90	>90
1.50	>90	>90
1.75	>90	>90
2.00	>90	>90

Table 3.6: Viscosity Of 4-SbO Modified PVA

4-SbQ (MOLE %)	Viscosity (cp)
0.50	12,700
1.00	32,900
1.25	>100,000
1.50	>100,000

The viscosities of these solutions were measured (Table 3.6 and 3.7). As shown earlier, the extent of grafting is similar for each photosensitive material and yet polymer solutions of very differing viscosities are produced. At

all solution concentrations the 4-SbQ modified PVA is much more viscous than the 2-SbQ modified PVA. One possible explanation is that the 4-SbQ moieties are more effective at aggregating. Hence the molecular weight of the polymer appears to increase which increases the viscosity of the polymer solution. This could be brought about by the interaction of the SbQ molecules with the hydroxyl groups on the backbone of the polymer. The SbQ molecules are charged species, in order to crosslink efficiently, they must align themselves in a head to tail fashion to give double bonds maximum overlap potential. When incorporated onto PVA, they must interact with the OH on the backbone in such a way as to allow the SbQ units to line up efficiently. If the hydroxyl group interacts with the quaternised nitrogen then this would allow the 4 substituted chromophores to align themselves in the desired manner whereas the 2 substituted chromophore would not achieve maximum overlap in the same place. The critical micelle concentration may be different for both the 2- and 4-SbQ aqueous PVA solutions. The SbQ unit is a surfactant and micelle formation will lead to aggregation of PVA-SbQ molecules.

Table 3.7: Viscosity Of 2-SbQ Modified PVA

2-SbQ (MOLE %)	Viscosity (cp)
0.50	8,560
1.00	9,800
1.25	11,280
1.50	12,240

A spectroscopic examination of these various materials should enable us to understand why the 2-SbQ modified polymers are less photosensitive than their 4-SbQ counterparts.

UV absorption spectra (diffuse reflectance) were examined for both 2- and 4-SbQ modified PVA films (tables 3.10 and 3.11). The absorption maxima of these samples are very different from the aqueous equivalents where λ_{max} are 338 and 342nm respectively. In the thin films, the shift to longer wavelengths are representative of aggregation of the SbQ chromophores. Also from tables 3.10 and 3.11, it can be seen that the 4-SbQ units aggregate much more efficiently than the 2-SbQ units when grafted onto PVA, hence producing a conformationally more stable system which undergoes photodimerisation more readily. In both cases as the amount of photosensitive chromophore increases then the extent of aggregation increases. Indicating that the aggregated state is concentration dependent. Comparing the aggregation to the speed of crosslinking in table 3.4,

it can be seen that efficient aggregation is necessary for fast crosslinking. While quoting diffuse reflectance λ_{max} 's it is important to realise that self-absorption and concentration effects may cloud what otherwise appears to be a clear picture.

Table 3.10: UV Absorption Maxima (Diffuse Reflectance) Of 4-SbO Modified Films

MOLE %	λ_{max} (nm)
0.50	360.1
1.00	364.7
1.25	367.6
1.50	373.8

Table 3.11: UV Absorption Maxima (Diffuse Reflectance) Of 2-SbO Modified Films

MOLE %	λ_{max} (nm)
0.50	349.1
1.00	352.5
1.25	358.2
1.50	359.6

The 2- and 4-SbQ modified PVA films (0.5, 1.0, 1.25 and 1.5) were studied by fluorescence spectroscopy.

Fluorescence spectroscopy has revealed some of the most fundamental information concerning the reactions of excited molecules. Across all film concentrations the fluorescence emission from the 4-SbQ modified PVA films is many times more intense than the 2-SbQ films. This is in contrast to the fluorescence emission spectra of the model compounds, 5 and 6, as shown in figures 3.3 and 3.4, where little difference in fluorescence intensity was observed. This could indicate that in the solid state the 2 substituted chromophores cannot aggregate as efficiently as they can in solution. This is possibly due to interactions of the hydroxyl group and the quaternised nitrogen of the SbQ groups. As stated earlier these interactions would allow the 4-SbQ to align themselves effectively for photodimerisation but not the 2-SbQ units.

Alternatively, Whitten et al have suggested that in solution the excited singlet state of 4-stilbazoles can almost completely be accounted for by fluorescence and intersystem crossing (cis-trans isomerisation) processes whereas in the case of the 2-stilbazoles major fractions of the excited singlet states are deactivated by some new, as yet unidentified process [24]. It is conceivable that these deactivation pathways exist in the solid state of the 2-SbQ salts and are therefore competing with the photodimerisation reaction.

In both the 2- and 4- substituted polymers, as the mole %

increases the emission band moves to longer wavelengths. This red shift is indicative of a shift from monomeric emission to excimeric emission. The fluorescence spectrum may be explained by the Forster-Kasper mechanism, [47], in terms of an excited dimer (S_0S_1)* formed by the combination of an excited singlet state molecule S_1 and an unexcited one S_0 . The increase in concentration increases the opportunity for dimerisation. This is verified in table 3.4.

These samples were subsequently irradiated with UV light using conventional curing apparatus (medium pressure Hg lamp). On irradiation the % of fluorescence drops rapidly as the photodimerisation reaction takes place. The emission band maxima also moves sharply to shorter wavelengths which corresponds to a shift from excimeric emission to monomeric emission (Tables 3.8 and 3.9). This experiment was also carried out under glass. The glass absorbed all the light under 310nm. This filter will cut out any back reaction such as the breaking of the cyclobutane ring with the subsequent regeneration of the double bonds. When the samples are exposed under glass, the new emission band is very sharp whereas when the samples are exposed without the glass filter, a broader peak is observed. From this it is possible to suggest that the glass eliminates a lot of the back reaction (Fig 3.8 and 3.9). The % drop in fluorescence maxima upon irradiation was calculated. When the glass filter is used the % drop in fluorescence is greater. Again, this is possibly due to the glass filter cutting down any back reaction.

Table 3.8: Decrease In Fluorescence Intensity Of 4-SbQ

Modified PVA Following Exposure To UV Light

			Exposed under glass		Exposed under glass
MOLE %	$\lambda_{max}(nm)$ 0 passes	$\lambda_{max}(nm)$ 10 passes	$\lambda_{max}(nm)$ 10 passes	Fluor % drop	Fluor % drop
0.50	420	415-420	415	58	60
1.00	445	435-440	420-425	64	61
1.25	445-450	430	420	70	62
1.50	455	425-435	420	70	74

Table 3.9: Decrease In Fluorescence Intensity Of 2-SbQ

Modified PVA Following Exposure To UV Light

			Exposed under glass		Exposed under glass
MOLE %	$\lambda_{max}(nm)$ 0 passes	$\lambda_{max}(nm)$ 10 passes	$\lambda_{max}(nm)$ 10 passes	Fluor % drop	Fluor % drop
0.50	410-415	410	410	46	54
1.00	420	415	410	47	53
1.25	435	415	410-415	48	62
1.50	445	425	415	59	70

Fig 3.11: Fluorescence Emission Spectra Of 0.5 Mole % 4-SbO Modified PVA And 2-SbO Modified PVA

A: 0.5 mole% 4-SbO modified PVA

B: 0.5 mole% 2-SbO modified PVA (Mag x20)

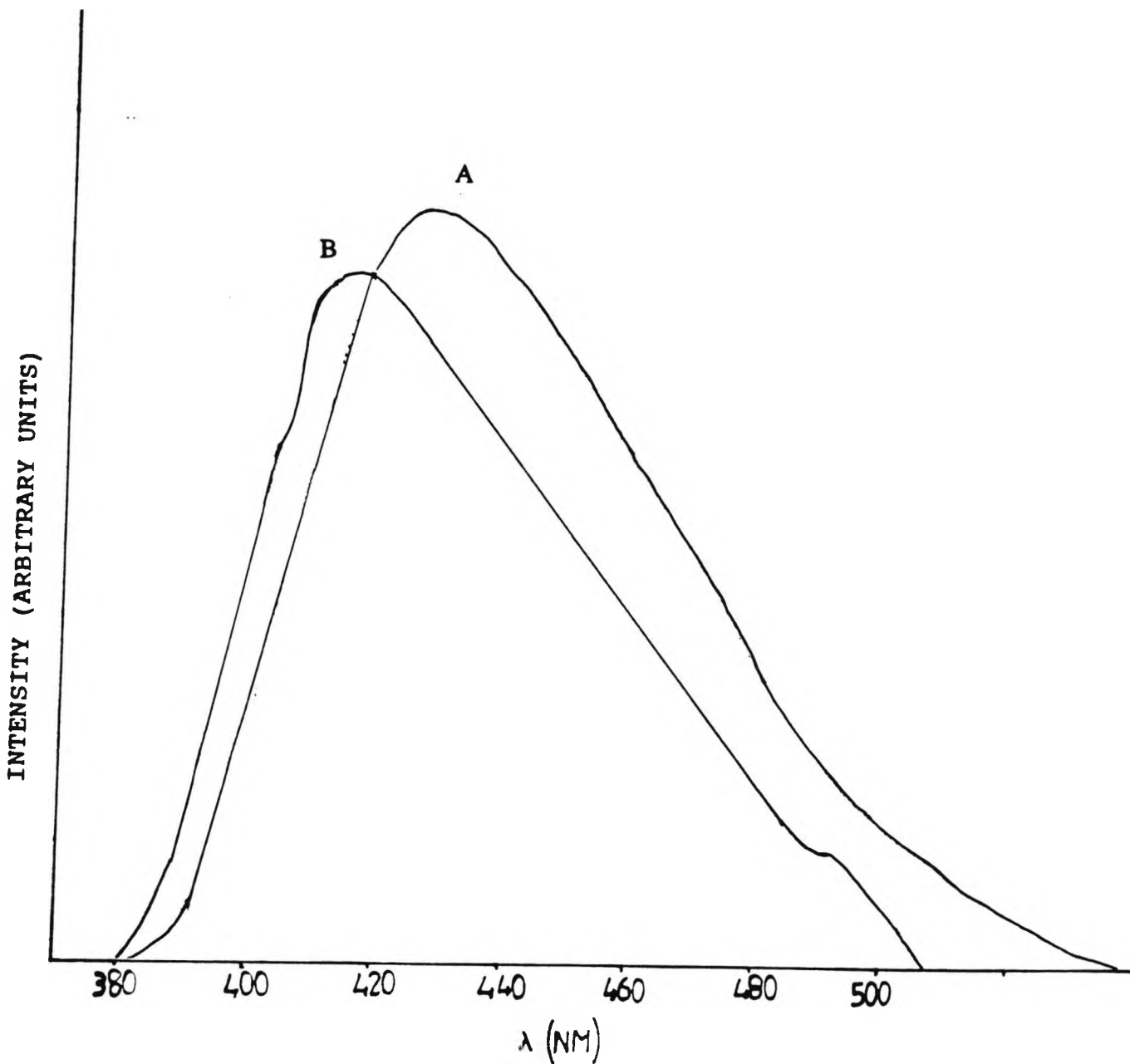

So far the speed of crosslinking has been related to the ability of the photosensitive groups to form properly orientated aggregates. To investigate whether these aggregates exist in the ground state excitation spectroscopy was employed. Excitation spectroscopy determines the best wavelength for promoting a system to an excited state. This wavelength is governed by both the absorbance of the compound and the intensity of the radiant energy. Excitation spectra are obtained by fixing the wavelength setting of the emission monochromator and scanning the wavelengths of the excitation monochromator.

Tables 3.15 and 3.16 list the λ_{max} of the excitation spectra of the 2- and 4-SbQ modified PVA films. The interpretation of excitation spectra is thwarted with difficulties due to inner filter effects. However, they are generally superimposable on the corresponding absorption spectra. In systems where there are molecular interactions in the ground state this rule breaks down.

Table 3.15: Excitation Spectra Maxima Of 4-SbQ Modified PVA Films (Emission Setting Fixed At 450nm)

MOLE %	Excitation Spectra Maxima (nm)
0.5	405
1.0	405
1.25	405
1.5	405

Table 3.16: Excitation Spectra Maxima Of 2-SbO Modified PVA Films (Emission Setting Fixed At 450nm)

MOLE %	Excitaion Spectra Maxima (nm)
0.5	400
1.0	400
1.25	400
1.50	400

From the shape of the excitation spectra it would appear that the wavelength maxima is a genuine value since perturbation from an inner filter effect would have manifested itself by the spectra at shorter wavelength being extremely noisy. To further prove the validity of the excitation spectra, spectra of these samples as aqueous solutions should have been obtained. Unfortunatley this was not possible due to the translucency of the samples. The study of these systems by UV (diffuse reflectance) and excitation spectroscopy indicate that the SbQ units possibly interact in the ground state such that dimerisation occurs via an excited ground state complex and not excimer formation as has previously been suggested. Tables 3.10 and 3.11 indicate that as the mole % of the photosensitive films increases the ground state interactions increase and hence the rate of photodimerisation increases.

Fig 3.12: Example Of Excitation Spectra (0.5 MOLE % 4-SbQ Modified PVA Film)

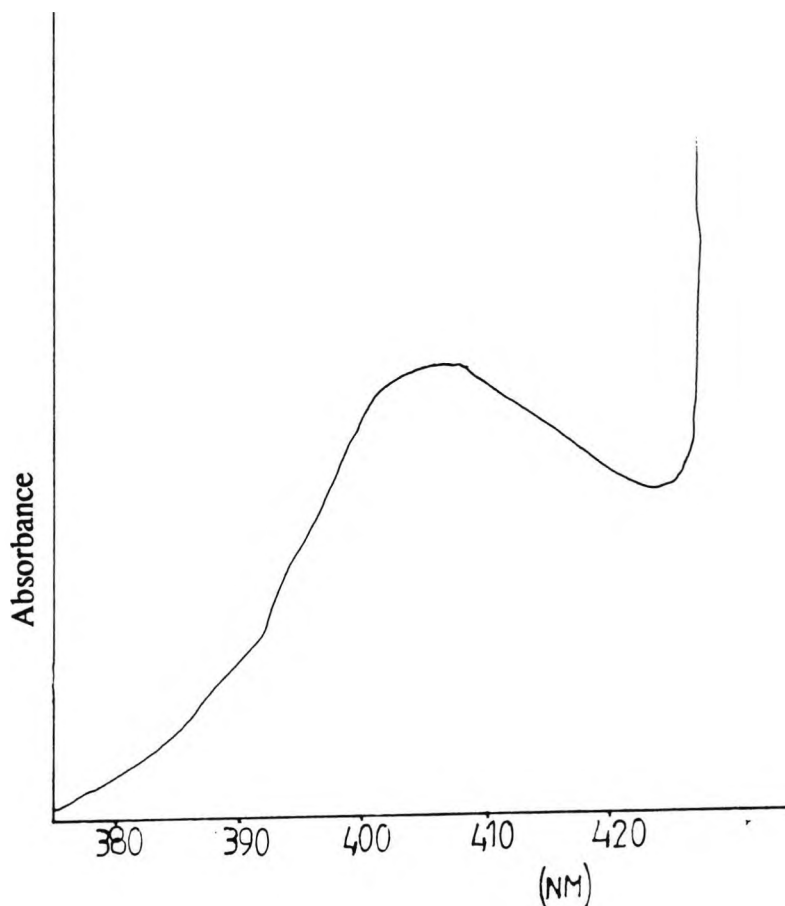

It has been suggested that in the solid state 4-SbQ modified PVA shows a higher degree of aggregation than the 2-SbQ equivalent. If this is the case then on dilution the 4-SbQ modified PVA micelle structure would be disrupted resulting in a decrease of fluorescence emission intensity.

Figs 3.13 and 3.14 reveal that this is indeed the case with 4-SbQ modified PVA sample losing its emission intensity at lower levels of dilution than the 2-SbQ modified polymer sample. The emission bands of both samples suffer a blue shift, ie as aggregates break up, monomeric emission takes over. The blue shift is more marked in the 4-SbQ samples again indicating greater disruption of the aggregation.

Fig 3.13: Fluorescence Emission Spectra Of 4-SbQ Modified PVA On Dilution With H₂O

A: 10% H₂O DILUTION
B: 25% H₂O DILUTION
C: 50% H₂O DILUTION
D: 75% H₂O DILUTION

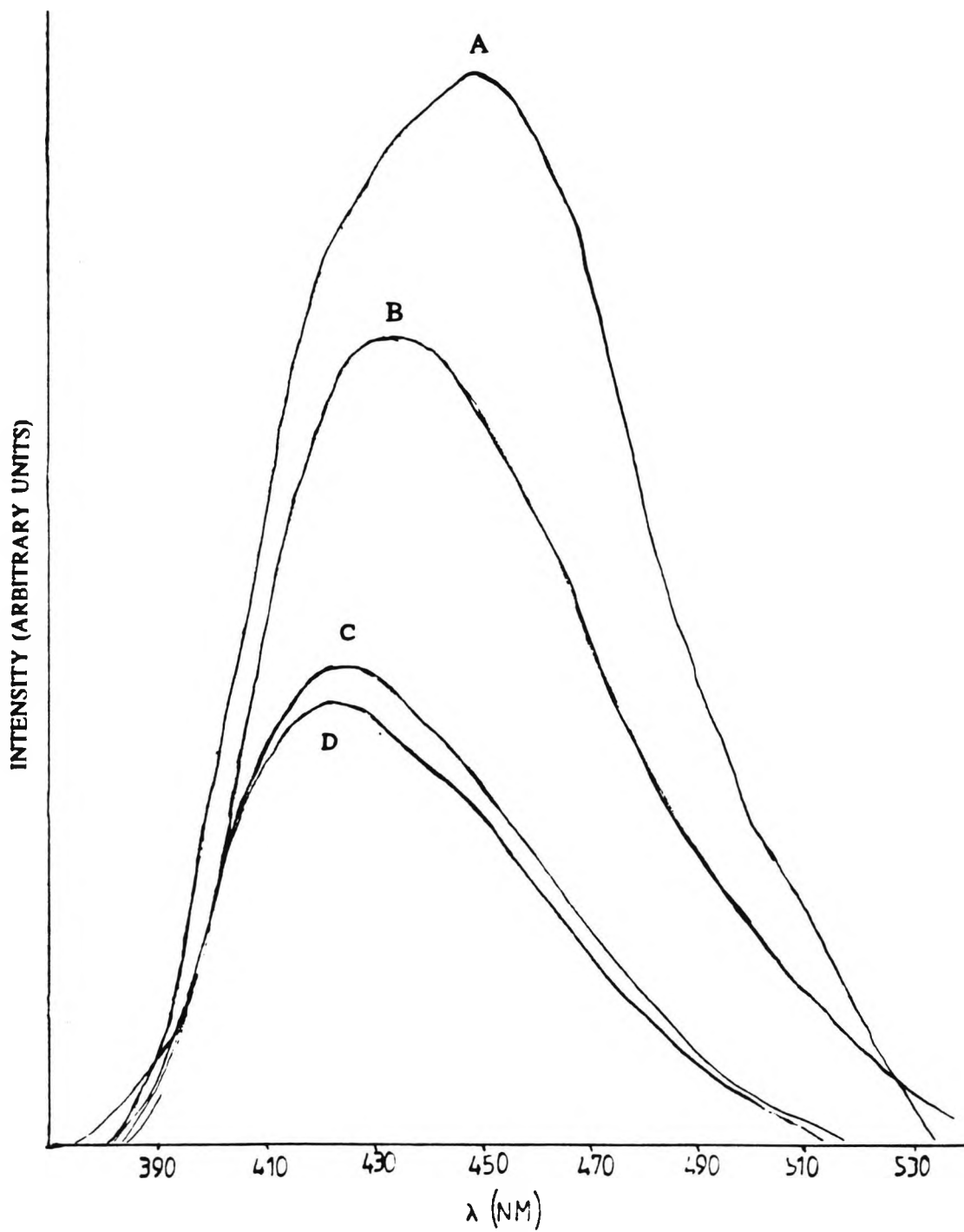
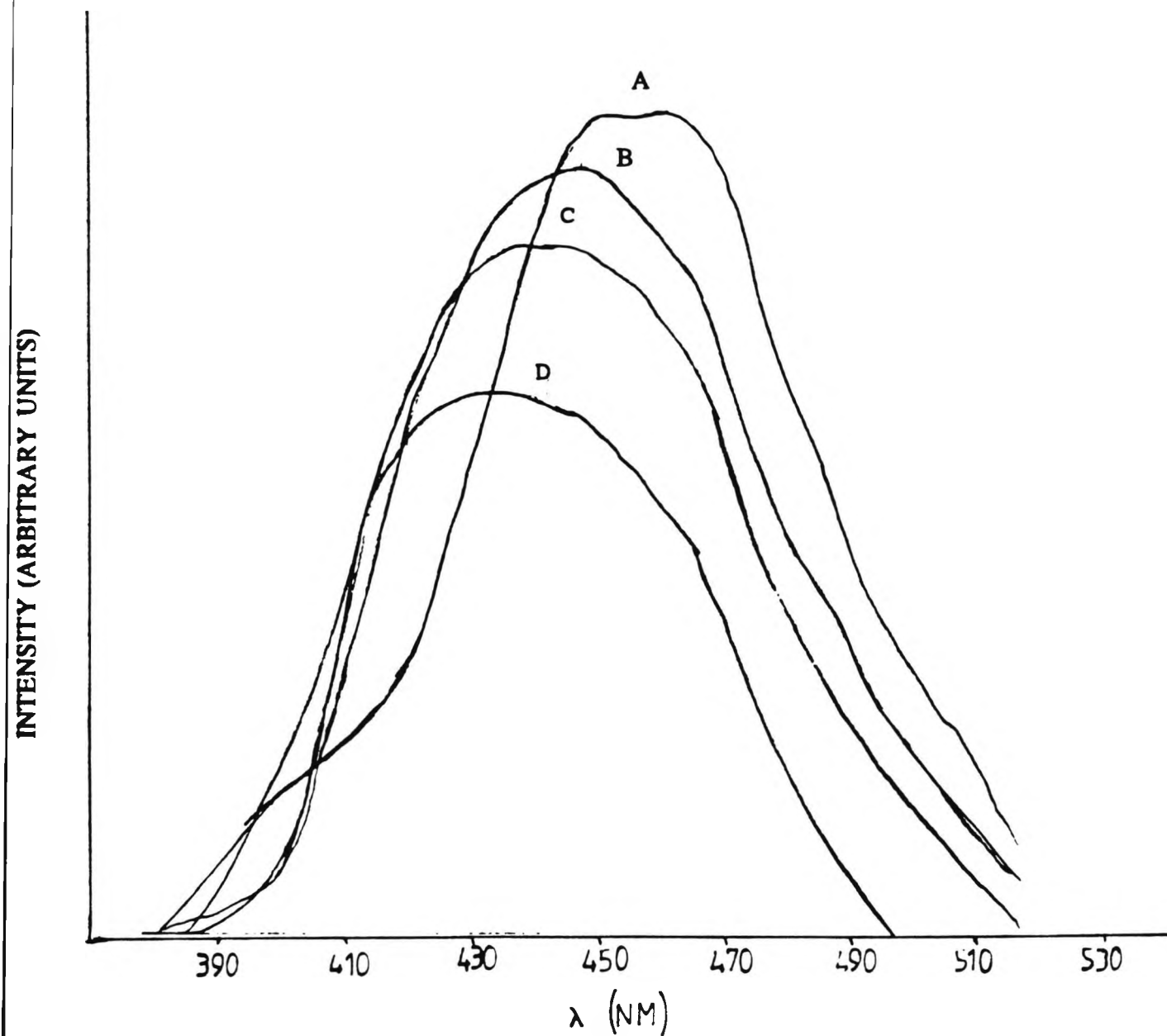

Fig 3.14: Fluorescence Emission Spectra Of 2-SbO Modified PVA On Dilution With H₂O

A: 10% H₂O DILUTION
B: 25% H₂O DILUTION
C: 50% H₂O DILUTION
D: 75% H₂O DILUTION



It was thought that the aggregation of 2-SbQ modified polymers could be enhanced, or at least made more efficient by the by the use of surfactants. Surfactants are those chemicals whose molecules have two parts of widely differing polarity and solubility [48]. Whatever the formula or type, all the surfactant molecules have in common polar and non polar portions. Thus one end of the surfactant molecule is attracted to polar molecules, while the other prefers a non polar environment. Thus if two components will not make chemical contact with each other surfactants can bridge the gap.

Two surfactants were tested. The first one was Crodafos (ethoxy (2) oleyl ether acid PO_4) and the second, the more water soluble pentrone s127 sulphone succinate (disodium salt of monoalkyl polyalkaline sulphosuccimate).

2-SbQ modified PVA solutions of varying mole % with added surfactant, weight for weight with the 2-SbQ salt were cast as thin films and exposed in a conventional exposure unit with a Stouffer stepwedge. The results are shown in tables 3.12 and 3.13. The presence of the surfactant did not improve the speed of insolubilisation and thus did not increase the extent of aggregation of the 2-SbQ moieties.

Table 3.12: Stepwedge Value For 2-SbO Modified PVA On Addition Of Crodafos

MOLE %	No Surfactant	Crodafos
0.5	washed out	washed out
1.0	10/11	10
2.0	15	15

Table 3.13: Stepwedge Value For 2-Sbq Modified PVA On Addition Of Pentrone

MOLE %	No Surfactant	Pentrone S127
0.5	washed out	washed out
1.0	10/11	10/11
2.0	15	16

The Stouffer stepwedge measures the rate of insolubilisation of photosensitive films and this has been related to the number of crosslinks formed. However, if the 4-SbQ modified PVA is less water soluble than 2-SbQ modified PVA then a higher stepwedge would be observed for the same exposure. If this was the case then the 4-SbQ modified PVA would have better water resistance than 2-SbQ modified PVA but would not have better solvent resistance.

The solvent resistance being directly related to the number of crosslinks formed as PVA is inherently solvent resistant.

The 2- and 4-SbQ films were exposed in a conventional UV cure apparatus until both gave the same stepwedge value; indicating that the same degree of insolubilisation had been achieved. A squeegee under a 1100g weight is drawn back and forth across the screen, an impression, in the presence of these materials. Table 3.14, indicates that 4-SbQ modified PVA is more resistant to both water and solvent than 2-SbQ modified PVA. The 4-SbQ modified polymer has formed a greater number of crosslinks during the same exposure, i.e. the 4-SbQ moiety is faster at crosslinking than the 2-SbQ. Also these results indicate that when 2-SbQ is attached to PVA, the resultant photosensitive polymer is more hydrophobic than when the 4-SbQ unit is attached.

Table 3.14: Resistance Tests For 2- And 4-Sbq Modified PVA

Sample	Solvent	Impressions	Comments
4-SbQ	H ₂ O	20	softened
2-SbQ	H ₂ O	5	washed out
4-SbQ	cyclohexanone	500	no change
2-SbQ	cyclohexanone	500	shows wear

3.4 Conclusions

In aqueous solution, 2- and 4-SbQ samples exhibit a shift to longer fluorescence wavelength as the concentration of each increases. The ability of the molecules to aggregate explains this excited complex emission. Both the 4- and the 2-styrylpyridines demonstrate a similar intensity of fluorescence, ie a similar efficiency of aggregation, in aqueous solution. However when the PVA backbone is modified with these chromophores the 4-SbQ modified PVA exhibits superior aggregation over the 2-SbQ modified PVA. This observation correlates with the speed of crosslinking found on exposure, i.e. the rate of crosslinking is related to the degree of aggregation of the photosensitive moieties. Emission spectra have shown that there is the possibility of interaction of these chromophores in the ground state of both 2- and 4-SbQ modified PVA films indicating that an excited complex rather than an excimer is the intermediary in the photodimerisation reactions [15]. Attempts to increase the aggregation of 2-SbQ modified PVA by the use of surfactants were unsuccessful. Evidence for the faster speed of crosslinking of 4-SbQ modified PVA over 2-SbQ modified PVA was also gained by measuring the resistance of exposed films to water and cyclohexanone. The physical tests revealed that the 4 substituted polymer was crosslinking faster than the 2 substituted equivalent.

3.5 References

1. F.H. Quina and D.G. Whitten, J. Amer. Chem. Soc., 97, 6, 1602 (1975)
2. K. Ichimura and S. Watanabe, J. Polym. Sci, Polym. Letts. Ed., 18, 613 (1980)
3. J.W. Happ, M.T. McCall and D.G. Whitten, J. Amer. Chem. Soc., 93, 21, 5496 (1971)
4. D.G. Whitten and Y.J. Lee, J. Amer. Chem. Soc., 92, 2, 415 (1970)
5. J. Kosar, "Light sensitive systems: Chemistry and application of non silver halide photographic processes", John Wiley and Sons, 1965
6. D.D. Reynolds and W.O. Kenyon, US Patent, 2,571,761 (1951)
7. J.L.R. Williams, US Patent, 2,908,667 (1959)
8. J.L.R. Williams and D.G. Borden, Makromol. Chem., 73, 203 (1964)
9. K. Ichimura, O. Takeuchi, H. Kusama, K. Yamazaki, A. Saki, K. Toyofuku, H. Ito, S. Ishizaka, K. Iwana, F. Tanaka, UK Patent, 2,174,977B (1989)
10. K. Ichimura, M. Ito, M Yamana and H. Ito, UK Patent, 2,174,977B (1989)
11. K. Ichimura, T. Yonezawa, H. Kikuchi, N. Tochizawa and K.Hayashi, European Patent, 0,246,885 (1987)
12. K. Ichimura, K. Kubo and S. Shimizo, European Patent, 0,252,150 (1988)
13. K. Ichimura, H. Itosh, S. Nakazato and H. Takazawa, European Patent, 0,261,981 (1988)
14. K. Ichimura, M. Ito and M. Yamana, US Patent, 4,777,114 (1988)
15. K. Ichimura and S. Watanabe, J. Polym. Sci., Polym. Chem. Ed., 20 , 1419 (1982)
16. K. Ichimura, J. Polym. Sci, Polym. Chem., 25, 3063 (1987)
17. K. Ichimura, J.Polym. Sci., Polym. Chem., 20, 1411 (1982)
18. J.L.R. Williams, R.E. Abel, J.M. Carlson, G.A. Reynold, D.G. Borden and J.A. Ford, J. Org. Chem., 28, 887 (1963)

19. A.P. Philips, J. Org. Chem., 12, 333 (1917)
20. L. Horwitz, J. Amer. Chem. Soc., 77, 1687 (1955)
21. B.D. Shaw and E.A. Wagstaff, J. Amer. Chem. Soc., 77 (1933)
22. G. Langer, Ber., 38, 3704 (1905)
23. S.T. Trippett, "Advances in organic chemistry, methods and reactions, vol 1 (Eds. R.A. Raphael, E.C. Taylor and H. Wynberg)", Interscience publishers inc., NY, 1960
24. D.G. Whitten and M.T. McCall, J. Amer. Chem. Soc., 91, 18, 5097 (1969)
25. C.A. Finch, "Polyvinyl alcohol, (Ed. C.A. Finch)", John Wiley and sons inc., NY, 1973
26. K. Ichimura and T. Komatsu, J. Polym. Sci., Polym. Chem. Ed., 25, 1475 (1987)
27. C.H. Nicholls and P.A. Leermakers, Adv. Phorochem., 8, 315 (1971)
28. L. Horwitz, J. Amer. Chem. Soc., 78, 1039 (1956)
29. M.S. Syamala and V. Ramamurthy, J. Org. Chem., 51, 3712 (1986)
30. V. Ito, Y. Uozu, T Dote, M. Uteda and T Matswira, J. Amer. Chem. Soc., 110, 189 (1988)
31. J. Saltiel et al, Pue Appl. Chem., 41, 561 (1975)
32. D. Valentine and G.S. Hammond, J. Amer. Chem. Soc., 94, 10, 3449 (1972)
33. M.A El-Sayed, J. Chem. Phys., 38, 2834 (1963)
34. A. Gilbert, "Synthetic organic photochemistry, (Ed. W.M. Horspool)", Plenum Press, 1984
35. M.Y. Li, E.M. Pearce and A. Reiser, J. Polym. Sci., Polym. Chem. Ed., 26, 2517 (1988)
36. H. Ulrich, P.V. Rao, F.A. Stuber and A.A.R. Sayigh, J. Org. Chem., 35, 4, 1121 (1970)
37. F.D. Lewis, Acc. Chem. Res., 152 (1979)
38. S.L. Mattes and S. Farid, Acc. Chem. Res., 15, 80 (1982)
39. C.A. Backer and D.G. Whitten, "Photochemistry On Solid Surfaces, (Eds. M. Anpo and T. Matura)", Elsevier, 1989

40. F.D. Lewis and D.E. Johnson, J. Photochem., 7, 412 (1977)
41. A. Reiser and E. Pitts, Photogr. Sci. Eng., 20, 225 (1976)
42. G.W. Jones, D. Russell, L.L. Simpson and G. Rosenthal, Proceedings Of Radcure Conference, 1986
43. E.S. Cockburn, R.S. Davidson, S.A. Wilkinson and J. Hamilton, Eur. Polym. J., 24, 10, 1015 (1988)
44. K. Ichimura, Makromol. Chem., 188, 2973 (1987)
45. R.S. Davidson, Adv. Phys. Org. Chem., 19, 1 (1983)
46. D.H. Williams and I. Fleming, "Spectroscopic methods in organic chemistry, 3rd edition", McGraw-Hill book company (UK) Ltd., 1980
47. T Forster and K. Kasper, Z. Elektrochem., 59, 977 (1955)
48. G.P.A. Turner, "Introduction to paint chemistry and principles of paint technology", Plenum Press, 1988

CHAPTER 4

Crosslinking Of Modified PVA Via A Mixed Cyclo-addition Reaction

4.1 Objective

In chapter 3, it has been shown that an excited SbQ group interacts with a ground state SbQ molecule resulting in a photocyclo-addition reaction. Eaton and de Mayo have shown that enones in an excited state can undergo cyclo-addition reactions with ground state alkenes [1,2,3,4]. It would be extremely advantageous if the idea of mixed cyclo-addition reactions could be extended to photosensitive PVA systems. The excessive introduction of more than 1.5 mole % of SbQ groups onto PVA makes the reaction mixture extremely viscous and finally leads to gelation. This phenomena limits the extent which photofunctional groups can be linked to PVA. The critical mole % of the styrylpyridinium derivatives required to cause gelation is dependent on the nature of the compound, the degree of polymerisation, the concentration of PVA in water and the kind of acid used in acetalisation.

It would be beneficial to retain the photosensitivity whilst decreasing the viscosity of the prepolymer. This can be achieved by the addition of certain solvents, e.g. water, but the reduction in solids contents has a detrimental effect on the definition of the image produced on crosslinking.

It was proposed that a suitable moiety (which does not absorb at the exciting wavelength but which could undergo a cyclo-

addition reaction with an excited SbQ chromophore) should be acetalised onto PVA. Following this strategy it should be possible to reduce the % of SbQ grafted onto the polymer, thereby producing free flowing and highly photosensitive solutions. This would also have economic benefits as SbQ is expensive to manufacture.

4.2 Introduction

In the early 1960's Eaton et al. investigated the photodimerisation of the simplest of the stable alicyclic conjugated ketones: cyclopent-2-enone [4]. Irradiation of cyclopentenone leads to an almost equal mixture of the two possible dimers in high yield (fig 4.1).

Fig 4.1:Dimerisation of Cyclopent-2-enone

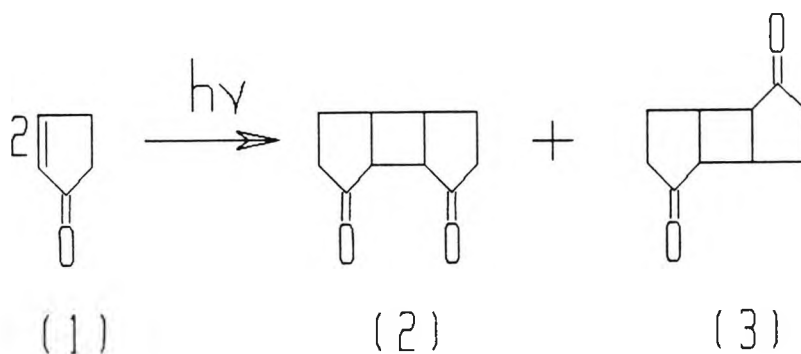

Although both dimers are sensitive to prolonged irradiation, no evidence of interconversion was found. The mechanism of the reaction depicted in fig 4.1 is excitation of the enone to its excited singlet state ($n \rightarrow \pi^*$), followed by intersystem crossing to the triplet state; T_2 or a species derived from it [2].

The charge distribution within the excited molecule at the time of the reaction is not known but fig 4.2 may be taken as a representation [1].

Fig 4.2: Representation Of Charge Distribution On Irradiation

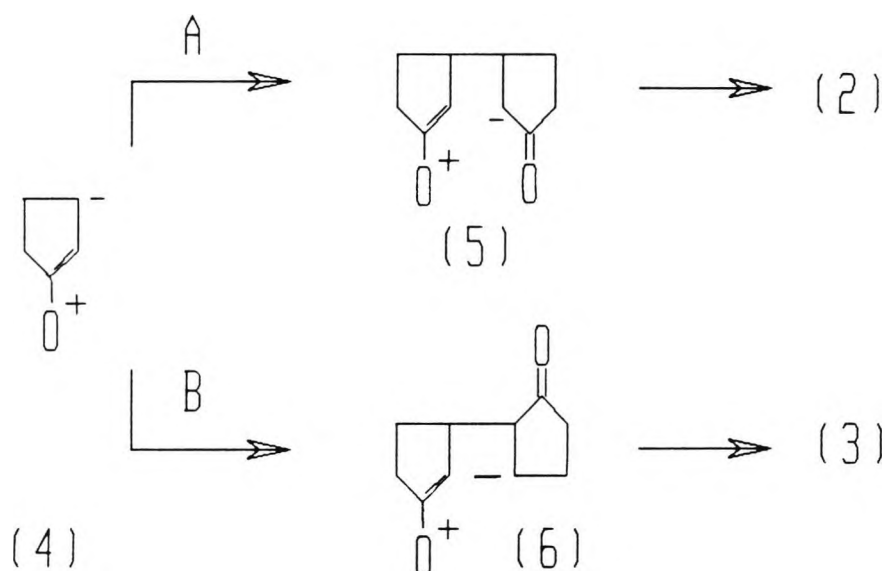

If the reaction is not concerted then the two reaction pathways A and B (fig 4.2) can be proposed. Interaction of the negative charge with the adjacent carbonyl should result in some stabilisation of (5) relative to (6), and dimer (2) should be more stable. The same conclusion can be reached by taking an uncharged diradical as the favoured form of excited state.

A non-concerted mechanism cannot be reconciled with the observation that dimers (2) and (3) are formed in similar yields unless the stabilization of the anion (or radical) in (5) by the adjacent carbonyl is inconsequential in comparison with the energies associated with (5) and (6).

Whichever of these pathways is correct it is explicit that the carbonyl group of the ground state molecule takes no part in the reaction. This suggests that it should be possible to react the excited enone with olefins other than those bearing a carbonyl group.

Eaton has shown that the irradiation of cyclopent-2-enone dissolved in cyclopentene leads to the cyclo-addition of cyclopentenone and cyclopentene in good yields (fig 4.3) [1].

Fig 4.3: Cyclo-Addition Reaction Of Cyclopentenone And Cyclopentene

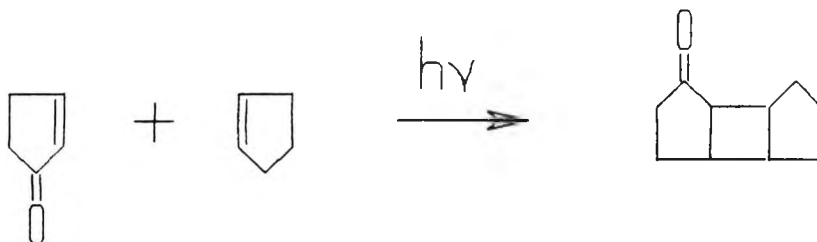

Earlier this century, Ciamician And Silber, observed light induced cyclobutane formation to occur intramolecularly between an olefin and an α,β -unsaturated ketone (fig 4.4) [5,6].

Fig 4.4: Intramolecular Cyclobutane Formation In A α,β -Unsaturated Ketone

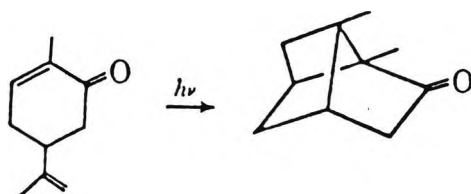

In this case, the proximity of the condensing π systems might well have special significance in that geometrically enforced orbital overlap could contribute to the ease of reaction.

Prior to the investigation of the photodimerisation of cyclopentenone and cyclopentene no intermolecular analogue of such a mixed cyclo-addition had been fully demonstrated despite the fact that de Mayo had postulated and later substantiated that this type of reaction took place in the photochemical synthesis of 1,5 diketones (fig 4.5) [2,3,7].

Fig 4.5: Photochemical Synthesis Of 1,5 Diketones

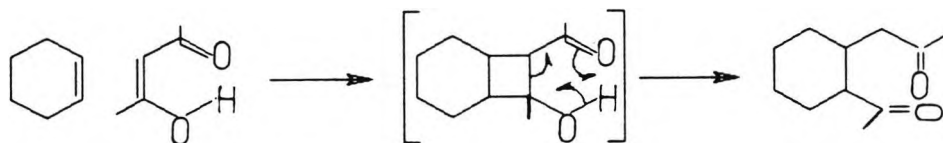

4.3 Results And Discussion

In order to begin this investigation, a readily available water soluble unsaturated aldehyde was chosen because aldehydes react readily, under mild conditions with PVA in aqueous media. The first material evaluated was 3-(2-furyl)acrolein.

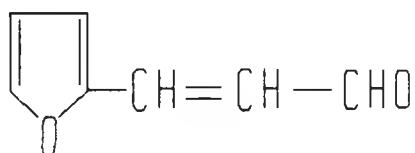

3-(2-furyl)acrolein

The preparation of a 1 mole % PVA-[3-(2-furyl)acrolein] was attempted but under the experimental conditions used, only 40% of the added aldehyde grafted onto the PVA backbone. Equal weights of the PVA-[3-(2-furyl)acrolein] solution and 4-SbQ-PVA (0.5, 1.0, 1.5 mole %) solution were physically mixed. These mixtures and 50:50 solutions of 4-SbQ-PVA (0.5,

1.0, 1.5 mole %) and PVA were coated onto a screen (120 HDW mesh, 2+2 coating) and exposed through stepwedges. A detailed explanation of the experimental procedure has been given in chapter 3, section 3.2.5.

Table 4.1: Stepwedge Values For Films Produced On Equal Exposure Of 4SbQ-PVA Solutions With And Without PVA Modified With 3-(2-Furyl)acrolein

4-SbQ-PVA (mole %)	PVA-[3-(2-furyl)acrolein (mole %)	Stepwedge
0.5	0.0	3
0.5	0.4	7
1.0	0.0	12
1.0	0.4	14
1.5	0.0	9
1.5	0.4	12

From table 4.1, it can be seen that at all three -PVA concentrations, the presence of 3-(2-furyl)acrolein increased the rate of insolubilisation. The greatest increase in insolubilisation was achieved with the 0.5 mole % 4-SbQ-PVA solution. In this case, the 4-SbQ and 3-(2-furyl)acrolein chromophores are present in almost a 1:1 ratio. Thus there is the greatest opportunity for the excited moiety to interact with the 3-(2-furyl)acrolein group. The efficiency of this

system can in principle be increased by producing a more highly grafted PVA-[3-(2-furyl)acrolein]. This supposition is confirmed by the results shown in table 4.2; thin films of 4-SbQ-PVA and PVA-[3-(2-furyl)acrolein] mixtures were exposed to UV light and the decreases in fluorescence intensity measured. As the amount of 3-(2-furyl)acrolein is increased the rate of photocyclo-addition is increased as indicated by the drop in the intensity of fluorescence.

Table 4.2: Decrease In Fluorescence Intensity Of 4-SbQ-PVA And PVA-[3-(2-furyl)acrolein] Mixtures

4SbQ-PVA (mole %)	PVA-[3-(2-Furyl)acrolein] (mole %)	% drop in fluorescence after 10 passes
EQUAL AMOUNTS (g)		
1.0	0.0	54
1.0	0.25	73
1.0	0.3	85
1.0	0.4	88

It has been shown conclusively in chapter 3, section 3.3.4, that the rate of crosslinking of the 2-SbQ-PVA solution is slower than that of the 4-SbQ-PVA solutions. The mixed cyclo-addition concept was extended to the 2-SbQ-PVA solutions.

Table 4.3: Stepwedge Values For Films Produced On Equal Exposure Of 2-SbQ-PVA Solutions With And Without PVA Modified With 3-(2-Furyl)acrolein

2-SbQ-PVA (mole %)	PVA-[3-(2-furyl)acrolein] (mole %)	Stepwedge
0.5	0.0	washed out
0.5	0.4	washed out
1.0	0.0	2
1.0	0.4	5
1.5	0.0	10
1.5	0.4	11

As shown in table 4.3, the presence of 3-(2-furyl)acrolein increases the rate of insolubilisation of 2-SbQ-PVA solutions. Again the ratio of SbQ to 3-(2-furyl)acrolein is important. As the mole % of the 2-SbQ groups increases, the increase in the rate of insolubilisation decreases. When the number of SbQ molecules greatly exceeds the number of 3-(2-furyl)acrolein units then it is possible that the SbQ molecules preferentially react with each other and thus decrease the effectiveness of the 3-(2-furyl)acrolein. Improving the percentage grafting of the 3-(2-furyl)acrolein would enhance the effectiveness of this system.

In order to study the electronic effects, if any, on these

mixed cyclo-addition reactions of functionalised PVA solutions as well as any reactant preordering, cinnamaldehyde, 4-methoxycinnamaldehyde and 4-cyanocinnamaldehyde were each acetalised onto PVA polymers [9]. It has been shown in chapter 3 that the SbQ molecules interact in the ground state. It is suggested that the three cinnamaldehyde derivatives should show different degrees of aggregation. Donor-acceptor interactions between the functional cinnamates and SbQ units should result in a change from intramolecular to intermolecular pair formation.

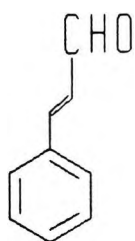

Cinnamaldehyde

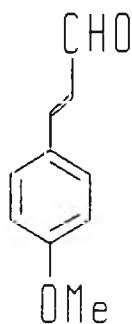

4-Methoxycinnamaldehyde

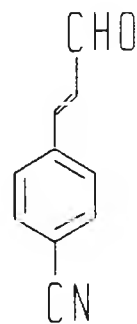

4-Cyanocinnamaldehyde

In each case a 1 mole % chromophore was prepared but in all cases only 42 - 49% grafting was achieved. These solutions were treated similarly to PVA-[3-(2-furyl)acrolein]

solutions. The results are shown in tables 4.4 and 4.5.

Table 4.4: Stepwedge Values From Films Produced On Equal Exposure Of 4-SbQ-PVA Solution With And Without PVA Modified With Various Cinnamaldehydes

EQUAL AMOUNTS (W/W)		Stepwedge
4-SbQ-PVA	PVA	9
4-SbQ-PVA	PVA-Cinnamaldehyde	9
4-SbQ-PVA	PVA-(MeO) Cinnamaldehyde	9
4-SbQ-PVA	PVA-(CN) Cinnamaldehyde	9

Table 4.5: Stepwedge Values From Films Produced On Equal Exposure Of 2-SbQ-PVA Solution With And Without PVA Modified With Various Cinnamaldehydes

EQUAL AMOUNTS (W/W)		STEPWEDGE
2-SbQ-PVA	PVA	2
2-SbQ-PVA	PVA-Cinnamaldehyde	2
2-SbQ-PVA	PVA-(MeO) Cinnamaldehyde	2
2-SbQ-PVA	PVA-(CN) Cinnamaldehyde	2

In this case the cinnamaldehyde and its derivatives did not appear to affect the rate of insolubilisation of the mixed

acetal solutions. This could be due to solubility problems encountered with cinnamaldehyde and its derivatives in the aqueous PVA environment which may lead to localised acetalisation thereby reducing the chances of aggregation or interaction of the SbQ molecules with the cinnamaldehyde units. It should be noted that cinnamaldehyde units dimerise efficiently via a triplet state and so could be inefficient at undergoing a cyclo-addition reaction with SbQ molecules which have been shown to dimerise via a singlet state. Physical quenching of SbQ molecules by cinnamaldehyde may be occurring preferentially.

If localised acetalisation was the reason for the failure of the cinnamaldehydes, the investigation of more water soluble moieties should push the potential of these mixed acetals further. Some of the simplest ethylenic aldehydes were considered such as acrolein and crotonaldehyde.



Acrolein

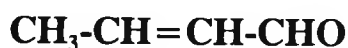

Crotonaldehyde

These moieties were acetalised onto PVA in aqueous solution using the same procedure as for 3-(2-furyl)acrolein and tested in the same manner. The % grafting of these

unsaturated aliphatic aldehydes could not be estimated by UV spectroscopy because their λ_{max} and ϵ were too low. During the acetalisation procedure there was an increase in viscosity which leads us to believe that modification of the aqueous PVA solutions by these simple unsaturated aliphatic aldehydes is taking place to some extent. No such viscosity increase is observed under similar conditions in the absence of aldehydes. The performance of these solutions on exposure to UV light are shown on tables 4.6 and 4.7.

Table 4.6: Stepwedge Values For Films Produced On Equal Exposure Of 4-SbQ-PVA Solutions With And Without PVA Modified With Acrolein And Crotonaldehyde

EQUAL AMOUNTS (W/W)		Stepwedge
4-SbQ-PVA	PVA	7
4-SbQ-PVA	PVA-Acrolein	9
4-SbQ-PVA	PVA-Crotonaldehyde	9

Table 4.7: Stepwedge Values For Films Produced On Equal Exposure Of 2-SbQ-PVA Solutions With And Without PVA Modified With Acrolein And Crotonaldehyde

EQUAL AMOUNTS (W/W)		Stepwedge
2-SbQ-PVA	PVA	4
2-SbQ-PVA	PVA-Acrolein	4
2-SbQ-PVA	PVA-Crotonaldehyde	5

2,4-Hexadienal has two ethylenic groups and if both these groups participated in crosslinking, the amount of the 2 or moiety required to cause insolubilisation could be further reduced (table 4.8)

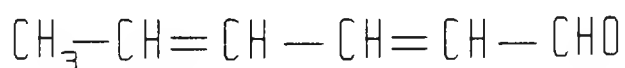

2,4 Hexadienal

Table 4.8: Stepwedge Values For Films Produced On Equal Exposure Of 2- Or 4-SbQ-PVA Solutions With And Without PVA Modified With Hexadienal

EQUAL AMOUNTS (W/W)		Stepwedge
4-SbQ-PVA	PVA	7
4-SbQ-PVA	PVA-Hexadienal	9
2-SbQ-PVA	PVA	4
2-SbQ-PVA	PVA-Hexadienal	7

From tables 4.6, 4.7 and 4.8, it can be seen that for the 4-SbQ-PVA solutions the acrolein, crotonaldehyde and 2,4-hexadienal do have a positive effect on the rate of insolubilisation. Unfortunately there is no benefit to be gained from the 2,4 hexadienal having two ethylenic groups. This may be due to the second ethylene group not being accessible to a moiety once one ethylene group has reacted.

The rate of insolubilisation of the 2-SbQ-PVA solutions are also enhanced by the presence of crotonaldehyde and even more so by the presence of 2,4 hexadienal. One inconsistency is that acrolein appears to have no effect.

Tables 4.1, 4.3, 4.6, 4.7 and 4.8 indicate that in most of the systems studied so far the mixed cyclo-addition reaction is most efficient in the 4-SbQ modified PVA systems. This observation is further substantiated on inspecting tables 4.9

and 4.10. Tables 4.9 and 4.10 list the λ_{max} 's achieved by UV (diffuse reflectance) spectroscopy of all the systems studied so far. It should be noted that as stated in Chapter 3, these λ values may not be true λ_{max} values. The shift in values may correspond to inner filter, self-absorption or concentration effects. The mixed systems containing 4-SbQ modified PVA have λ_{max} 's which are shifted to longer wavelengths on the introduction of a simple ethylenic aldehyde whereas only the 2-SbQ modified PVA solution mixed with hexadienal modified PVA shows any bathochromic shift.

In chapter 3, it has been shown that the SbQ units possibly interact in the ground state. The UV spectroscopy (diffuse reflectance) investigation show similar results for the mixed systems containing 4-SbQ modified PVA. However the results are not conclusive for the mixed systems containing 2-SbQ modified PVA.

Table 4.9: UV (Diffuse Reflectance) Spectra Of -PVA Physically Mixed With PVA, PVA-[3-(2-Furyl)acrolein], PVA-Acrolein, PVA-2,4 Hexadienal And PVA-Crotonaldehyde

EQUAL AMOUNTS (W/W)		λ_{max} (nm)
4-SbQ-PVA	PVA	360
4-SbQ-PVA	PVA-3-(2-Furyl)acrolein	370
4-SbQ-PVA	PVA-Acrolein	368
4-SbQ-PVA	PVA-2,4 Hexadienal	368
4-SbQ-PVA	PVA-Crotonaldehyde	362

Table 4.10: UV (Diffuse Reflectance) Spectra Of 2-SbQ-PVA Physically Mixed With PVA, PVA-[3-(2-Furyl)acrolein], PVA-Acrolein, PVA-2,4 Hexadienal And PVA-Crotonaldehyde

EQUAL AMOUNTS (W/W)		λ_{max} (nm)
2-SbQ-PVA	PVA	349
2-SbQ-PVA	PVA-[3-(2-furyl)acrolein]	348
2-SbQ-PVA	PVA-Acrolein	348
2-SbQ-PVA	PVA-Hexadienal	353
2-SbQ-PVA	PVA-Crotonaldehyde	349

The fluorescence spectra of the mixed systems of both the 2- and 4-SbQ modified PVA solutions reveal some interesting mechanistic information. Tables 4.11 and 4.12 list the fluorescence emission of the mixed systems. All the films containing 4-SbQ modified PVA exhibit λ_{max} 's corresponding to monomeric emission whereas in Chapter 3 it has been shown that faster crosslinking is accompanied by a shift to longer wavelengths due to aggregation of the photosensitive units. This observation strengthens the opinion that efficient aggregation of a 4-SbQ unit and a second ethylenic aldehyde is occurring because if the 4-SbQ units were aggregating then a red shift would be observed in the fluorescence spectra.

Alternatively, the fluorescence spectra of the mixed solutions containing 2-SbQ modified PVA have emission λ_{max} 's similar to those observed for a photosensitive solution containing 2-SbQ only. It is interesting to note that the bathochromic shift is longer than when only 2-SbQ units are present. It would appear that in the mixed systems containing 2-SbQ that the cyclo-dimerisation reaction predominates over a mixed cyclo-addition reaction. The question arises as to whether any observed increase in the rate of crosslinking for mixed systems containing 2-SbQ modified PVA is due to a mixed cyclo-addition reaction or whether the presence of the other ethylenic aldehyde is encouraging the 2-SbQ units to cyclo-dimerise.

Table 4.11 Fluorecence Emission Maxima Of The Mixed Systems Containing 4-SbO Modified PVA

EQUAL AMOUNTS (W/W)		EMISSION MAXIMA (NM)
4-SbQ-PVA	PVA	420-425
4-SbQ-PVA	PVA-3-(2-Furyl)acrolein	420-425
4-SbQ-PVA	PVA-Acrolein	420-425
4-SbQ-PVA	PVA-2,4 Hexadienal	420-425
4-SbQ-PVA	PVA-Crotonaldehyde	420-425

Table 4.12: Fluorescence Emission Maxima for Mixed Systems Containing 2-SbO Modified PVA

EQUAL AMOUNTS (W/W)		EMISSION MAXIMA (NM)
2-SbQ-PVA	PVA	440-460
2-SbQ-PVA	PVA-3-(2-Furyl)acrolein	440-460
2-SbQ-PVA	PVA-Acrolein	440-460
2-SbQ-PVA	PVA-2,4 Hexadienal	440-460
2-SbQ-PVA	PVA-Crotonaldehyde	440-460

For the experiments discussed so far the two modified PVA solutions had been physically mixed. It was proposed that if the two crosslinking units were co-acetalised in the same aqueous PVA solution there would be greater association of the two groups which would lead to an greater increase in the speed of crosslinking (tables 4.8 and 4.9). Co-acetalisation was carried out by firstly grafting the SbQ units onto polyvinyl alcohol as described in Chapter 3, Section 3.3.2. The ethylenic aldehyde was introduced to the reaction mixture after 1 hour.

From table 4.13, it can be seen that when the 2- or 4-SbQ salts are co-acetalised with cinnamaldehyde and its derivatives, there is no increase in the rate of insolubilisation. This agrees with the results of the physical mixing experiments on these materials. Surprisingly this was also the case with the 3-(2-furyl)acrolein unit. The co-acetalisation of 4-SbQ-PVA with acrolein and crotonaldehyde gave more promising results (table 4.14)

Table 4.13: Stepwedge Values For Films Produced On UV Irradiation Of 2- Or 4-SbQ Modified PVA Co-acetalised With Cinnamaldehyde And Its Derivatives And 3-(2-Furyl)acrolein

CO-ACETALISATION EQUIVALENT (MOLE %)	Stepwedge
4-SbQ-PVA	10
PVA-Cinnamaldehyde	10
PVA-(OMe)Cinnamaldehyde	10
PVA-[3-(2-Furyl)acrolein]	10
2-SbQ-PVA	9
PVA-2-SbQ-Cinnamaldehyde	8
PVA-2-SbQ-(MeO)Cinnamaldehyde	8
PVA-2-SbQ-[3-(2-Furyl)acrolein]	8

Table 4.14: Stepwedge Values For Films Produced On UV Irradiation Of 4-SbQ Modified PVA Co-acetalised With Acrolein And Crotonaldehyde

CO-ACETALISATIONS EQUIVALENT (MOLE %)	STEPWEDGE
4-SbQ-PVA	10
PVA-4-SbQ-Acrolein	13
PVA-4-SbQ-Crotonaldehyde	13

The UV λ_{max} 's (Diffuse Reflectance Spectroscopy) of the co-acetalised systems are all shifted to longer wavelengths (Table 4.15). This would indicate that if the λ values are true λ_{max} 's there is interaction of these chromophores in the ground state yet no increase in the rate of photocrosslinking has been observed. It has been shown that aggregation of the ethylenic units is a prerequisite for fast and efficient crosslinking in SbQ modified PVA. However it would appear that aggregation can be achieved which does not result in an improved rate of crosslinking.

It is possible that differences in the water solubility of the cinnamaldehydes, 3-(2-furyl)acrolein, acrolein and crotonaldehyde can also affect the crosslinking efficiency of the systems. The technique used in the co-acetalisation procedure involved the acetalisation of 2- or 4-SbQ units onto a PVA backbone followed by the introduction of a second ethylenic aldehyde. The more water soluble compounds may acetalise onto a PVA strand which already has a SbQ molecule attached to it. Thereby increasing the chances of interaction between the groups but any resultant cyclo-addition reactions would not result in an increase in molecular weight leading to insolubilisation.

As stated earlier cinnamaldehyde and its derivatives may be inefficient at a cyclo-addition reaction with a stilbazolium type molecule even when aggregation of the molecules can be achieved.

Table 4.15: Stepwedge Values Achieved On the Irradiation With UV Light Of Films Obtained From CO-Acetalised Solutions

EQUIVALENT MOLE %		λ_{max} (nm)
4-SbQ-PVA	PVA	360
PVA-4-SbQ-[3-(2-Furyl)acrolein]		370
PVA-4-SbQ-Acrolein		386
PVA-4-SbQ-Cinnamaldehyde		370
PVA-4-SbQ-(MeO)Cinnamaldehyde		373

So far we have shown that certain unsaturated aldehydes increase the rate of insolubilisation of 2- or 4-SbQ modified PVA polymers. It is possible that these non SbQ aldehydes are affecting the crosslinking efficiency by modifying the solubility of PVA, e.g. the closer the PVA is to being insoluble in water the fewer crosslinks are necessary to render it sufficiently water insoluble for the stencil to be developed with water. A stencil of this type would not have the same solvent resistance as a system with more crosslinks.

To establish whether mixed crosslinking or solubility changes are taking place an investigation into the mechanistic aspects of these systems as well as their solvent resistance was carried out.

The stepwedge values quoted so far are a measure of insolubility which is not necessarily directly related to the number of crosslinks formed during irradiation. Thus to establish whether the presence of these simple aliphatic olefins are contributing to the crosslinking or merely changing the solubility of these systems; the photosensitive solutions in table 4.16 were irradiated to give a step wedge of 4, ie the same degree of insolubility. These test images were rubbed with a squeegee in an automatic rub-tester in the presence of water or an organic solvent, e.g. cyclohexanone, to compare their solvent resistances and hence their degree of crosslinking. The system with most crosslinks will have greater resistance even though the insolubility is the same.

Table 4.16: Rub Tests Of Images Produced On UV Irradiation Of 4-SbQ-PVA Solution Physically Mixed With PVA, PVA-[3-(2-Furyl)acrolein] and PVA-Acrolein Solutions

Equal Amounts (W/W)	Solvent	Impressions	Comments
4-SbQ-PVA/PVA	H ₂ O	20	Clean on one side, soft on other side
4-SbQ-PVA/PVA-[3-(2-Furyl)acrolein]	H ₂ O	20	clean on one side, soft on other side
4-SbQ-PVA/PVA-Acrolein	H ₂ O	20	clean on one side, soft on other side
4-SbQ-PVA/PVA	cyclohexanone	500	softening
4-SbQ-PVA/PVA-[3-(2-Furyl)acrolein]	cyclohexanone	500	no impression
4-SbQ-PVA/PVA-Acrolein	cyclohexanone	500	no impression

As expected all the samples show poor but similar water resistance. All samples show much better solvent resistance. The fact that the 4-SbQ-PVA/PVA mixture shows softening indicates less crosslinks are formed. This is what you would expect if the other aldehydes were participating in crosslinking. However, the differences in the rub tests were not striking enough to be totally conclusive.

In order to obtain more conclusive evidence of a mixed cyclo-addition occurring, PVA was modified with aldehyde units

which did not have an ethylenic double bond available for crosslinking. It was hoped that if the increase in the rate of insolubilisation was only due to a change in solubility of the polymer backbone then introducing this new aldehyde would have a similar affect. Alternatively if a mixed cyclo-addition reaction was occurring than no increase in insolubilisation would be observed.

Attempts were made to hydrogenate the acyclic double bond of 3-(2-furyl)acrolein using Pd/C (2%) as a catalyst in acetic acid to produce 3-(2-furyl)propionaldehyde [10]. Unfortunately no reaction conditions were found which produced the desired product exclusively. From the nmr spectra of the product obtained it appeared that once some acyclic double bonds are hydrogenated the cyclic double bond and the C=O are hence attacked. 5-Ethylfurfural was grafted onto PVA; this aldehyde like 3-(2-furyl)propionaldehyde does not have an acyclic double bond.

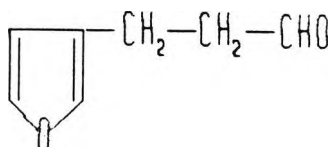

3-(2-furyl)propionaldehyde

This solution was tested in a similar manner to those described previously (table 4.17).

Table 4.17: Stepwedge Values For Films Produced On Equal Exposure Of 4-SbQ-PVA Solutions Physically Mixed With PVA And PVA-5Ethylfurfural Solutions

EQUAL AMOUNTS (W/W)		Stepwedge
4-SbQ-PVA	PVA	7/8
4-SbQ-PVA	PVA-5Ethylfurfural	7/8

From table 4.17 it can be seen that the presence of 5-ethylfurfural does not increase the rate of insolubilisation. This result indicates that when PVA-3-(2-furyl)acrolein is mixed with 2- or 4-SbQ modified PVA any observed increase in the rate of insolubilisation is due to mixed crosslinking of the SbQ moiety with the acyclic double bond of the 3-(2-furyl)acrolein. The cyclic double bonds of 3-(2-furyl)acrolein do not participate in the cyclo-addition reaction. This fact was further substantiated by modifying PVA with 2-furfural, mixing it with PVA in a 1:1 ratio and irradiating it in the presence of a Du Pont - Howsen stepwedge. By comparing tables 4.17 and 4.18, it can be seen that PVA modified with 2-furfural does not increase the rate of insolubilisation when mixed with 4-SbQ-PVA. This observation agrees with the statement already made that the cyclic double bonds of 3-(2-furyl)acrolein do not participate in the cyclo-addition reaction.

Table 4.18: Stepwedge Values For Films Produced On Equal Exposure Of 4-SbQ-PVA Solutions Physically Mixed With PVA And PVA-2Furfural Solutions

EQUAL AMOUNTS (W/W)		Stepwedge
4-SbQ-PVA	PVA	7/8
4-SbQ-PVA	PVA-2Furfural	7/8

The resistance of the mixed photosensitive systems containing 5-ethylfurfural and 2-furfural were tested in the manner already described. The results shown in table 4.19 support the view that 5-ethylfurfural and 2-furfural take no part in the insolubilisation of the mixed system.

Comparing tables 4.10 and 4.19 reveals that the grafting of acrolein, 3-(2-furyl)acrolein, 5-ethylfurfural and 2-furfural onto a PVA backbone has neither a deleterious or beneficial effect on the water solubility of the PVA strands. This is not surprising since the level of aldehyde grafted onto the PVA backbone is so small. Hence any increase in the rate of insolubilisation observed when PVA-3-(2-furyl)acrolein or PVA-acrolein is mixed with 2- or 4-SbQ-PVA, is a result of the double bond of the 3-(furyl)acrolein or acrolein participating in a mixed cyclo-addition reaction with the SbQ units and not due to any increase in the hydrophobicity of the modified PVA strands.

Table 4.19: Rub Tests Of Films Produced On Equal Exposure To UV Light Of 4-SbQ-PVA Solutions Physically Mixed With PVA, PVA-(5-Ethylfurfural) And PVA-(2-Furfural)

EQUAL AMOUNTS (W/W)		Solvent	Impressions	Comments
4-SbQ-PVA	PVA	H ₂ O	20	gone on both sides
4-SbQ-PVA	PVA-(5-Ethylfurfural)	H ₂ O	20	gone on both sides
4-SbQ-PVA	PVA-(2-Furfural)	H ₂ O	20	gone on both sides
4-SbQ-PVA	PVA	cyclohexanone	500	no impression
4-SbQ-PVA	PVA-(5-Ethylfurfural)	cyclohexanone	500	no impression
4-SbQ-PVA	PVA-(2-Furfural)	cyclohexanone	500	no impression

So far the reaction conditions used for modifying the PVA were those which gave optimum levels of grafting of 2- or 4-SbQ. In the modification of PVA by these simpler aldehydes the maximum levels of grafting was approximately 40%. This leads to an inefficiency in the mixed systems as the SbQ unit has a greater opportunity of reacting with another SbQ

molecule than the other aldehyde. Also under homogeneous conditions, any ungrafted aldehyde is not removed from the system and so can potentially undergo a cyclo-addition reaction with a grafted SbQ moiety with no net increase in molecular weight. Therefore, in order to increase the potential efficiency of mixed cyclo-addition systems, higher levels of grafting have to be achieved or unreacted aldehyde removed by a purification procedure.

Attempts were made to modify PVA with 3-(2-furyl)acrolein by various homogeneous and heterogeneous methods to increase the levels of grafting. In order to calculate accurate levels of grafting, especially from the heterogeneous methods, it was necessary to calculate the molar extinction coefficient of the 3-(2-furyl)acrolein acetal. The acetal formed by acid acetalisation of PVA and 3-(2-furyl)acrolein is approximated to the acetal generated by the acid acetalisation of ethylene glycol and 3-(2-furyl)acrolein. The application of the Beer-Lambert law (equation 3.1) gives a molar extinction coefficient of 15000. This value was then used to calculate the percentage of acetal formed during the various reaction conditions (table 4.20).

Table 4.20: The % Grafting Obtained By The Homogeneous Acetalisation Of PVA By 3-(2-Furyl)acrolein Under Various Conditions

PVA (g)	3-(2-Furyl)acrolein (g)	H ₃ PO ₄ (ml)	Temp (°C)	Time (hrs)	% Grafting
100	0.36	2	60	24	26
100	0.36	2	60	5	37
100	0.36	2	60	2	40
100	0.36	2	25	2	53
100	0.36	2	25	4	60

Table 4.20 shows that the levels of grafting are greatly increased when the homogeneous acetalisation is carried out at 25°C. More experiments are necessary to achieve a maximum level of grafting. Modification using homogeneous conditions demand precipitation by solvent followed by resolubilisation in water. Due to this more time was spent on increasing the levels of grafting by heterogeneous methods. Experiments using heterogeneous methods of grafting were carried out but only 20 - 25% grafting could be achieved. A more detailed survey of the attempted acetalisations (homogeneous and heterogeneous) is given in the experimental section, chapter 6)

4.4 Conclusions

It has been shown that the required levels of 4-substituted stilbazolium salt on a polymer backbone can be reduced by physically mixing the modified polymer with another PVA solution which has been modified with another suitable unsaturated aldehyde such as 3-(2-furyl)acrolein, acrolein, crotonaldehyde and hexadienal.

The results are consistent with mixed cyclo-addition reaction taking place upon irradiation, thereby increasing the rate of insolubilisation relative to the cyclo-dimerisation of the stilbazolium salt alone under similar conditions. There is spectroscopic evidence that the cyclo-addition reaction of mixed systems containing 4-SbQ modified PVA occurs via irradiation of an excited complex.

The mixed systems containing 2-SbQ modified PVA when exposed through a stepwedge do not give as great an increase in the rate of polymerisation as the mixed systems containing 4-SbQ modified PVA. From the fluorescence spectra it appears the cyclo-dimerisation of the 2-SbQ units predominates in these systems. It has not been established whether the observed increase in crosslinking of the mixed systems containing 2-SbQ modified PVA occurs because of a mixed cyclo-addition reaction or because the introduction of a second ethylenic unit is encouraging the 2-SbQ units to react.

4.4.1 Future Work

In order to substantiate the results, as well as increasing the efficiency of these mixed cyclo-additions several areas

of work remain to be tackled. The grafting of each aldehyde has to be optimised so that PVA solutions containing similar levels of each aldehyde can be directly compared. At present, differences in the behaviour between the aldehydes could be due to differing:-

1. levels of grafting,
2. hydrophobicity of PVA-aldehyde solution,
- 3 degree of aggregation of aldehyde with SbQ,
4. efficiency of mixed dimerisation.

One possible way to improve the mixed cyclo-addition reaction could be by the use of more water soluble aldehydes such as quaternised 3-pyridylprop-2-enal (scheme 4.1) [11,12].

Scheme 4.1 Preparation Of 3-Pyridylprop-2-enal

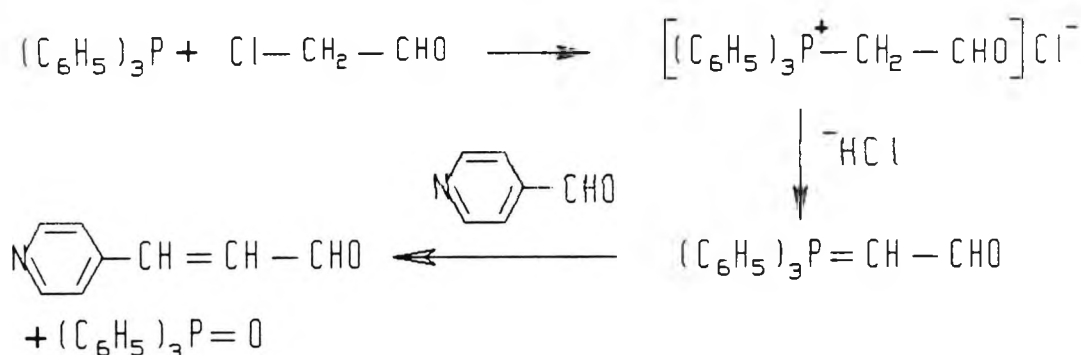

Improving the water solubility of the aldehyde would make the homogeneous grafting procedure easier. Also chromophores of this type would have a λ_{max} at longer wavelengths than the acrolein and crotonaldehyde units thus enabling the grafting procedure to be monitored by UV spectroscopy. By this technique, conditions for the maximum grafting of appropriate ethylenic aldehydes could be found.

4.5 References

1. P.E. Eaton, *Accts. Chem Res.*, 1, 50 (1968)
2. P. de Mayo, J.P. Pete and M. Tchir, *J.Amer. Chem. Soc.*, 89, 22, 5712 (1967)
3. P. de Mayo and H. Takeshita, *Can. J. Chem.*, 41, 440 (1963)
4. P.E. Eaton, *J. Amer. Chem. soc.*, 84, 2454 (1962)
5. G. Ciamician and P. Silber, *Ber.*, 41, 1028 (1908)
6. G. Buchi and I.M. Goldman, *J. Amer. Chem. Soc.*, 79, 4741 (1957)
7. E.J. Corey, J. Dolf-Bass, R. Le Mahieu and R.B. Mitra, *J. Amer. Chem. Soc.*, 86, 5570 (1964)
8. U. Ghosh and T.N. Misra, *J. Polym. Sci, Polym. Chem.*, 26, 1681 (1988)
9. A.A. Lin and A. Reiser, *MACromolecules*, 22, 3898, (1989)
10. W. Carruthers, "Some Modern Methods Of Organic Synthesis", Cambridge University Press, 1978
11. I. Hagedorn and W. Hohler, *Angew. Chem. Internat. Edit.*, 14, 7, 486 (1975)
12. G. Wittig, *Pure Appl. Chem.*, 9, 245 (1964)
13. S.H.Pine, J.B.Hendrickson, D.J.Cram and G.S.Hammond, "Organic Chemistry", McGraw-Hill Book Company, 1980

Polyvinyl Alcohol Modified With Styrylpyridiniumboronic
Acids

5.1 Objective

Photosensitive PVA is prepared by modifying the PVA with a stilbazolium salt resulting in an acetal linkage. This acetalisation reaction is acid catalysed and reversible. In order to prepare photosensitive polymers with more controllable properties; new, simpler ways of linking these chromophores are required. The work of Kuivila and co-workers have shown that the reaction of boronic acid with diols and polyols to produce areneboronates occur in the absence of an acid catalyst. It may be possible to capitalise on this chemistry in the preparation of light sensitive PVA polymers. So far the photosensitive chromophore has been anchored to the PVA backbone via a carbonyl group resulting in an acetal linkage. If a boronic moiety could be incorporated into stilbazolium salt, then it may be possible to modify the PVA under neutral to basic conditions.

Attachment via the boronate group capitalises on the fact that the predominant repeat group in PVA is a 1,3 diol. The 6 membered boronate ester is more stable than the 5 membered ring system as shown in the work by Kuivila and co-workers [1] and more recently by Suigihara and Bowman [2]. Therefore an investigation into the preparation and acetalisation onto

PVA of styrylpyridiniumboronic acids and model compounds was undertaken.

5.2 Introduction

Kuivila and co-workers [1] have shown that on shaking a saturated solution of mannitol with excess benzenboronic acid; the latter did not dissolve as was expected. The boronic acid was replaced by a voluminous precipitate. This precipitate was proven to be an ester of the boronic acid. Several structures for this ester were postulated. Polymeric ester formation had been suggested but this was discarded on the basis of molecular weight determinations. The results of molecular weight experiments corresponds to the molecular structures 1 and 2; a five and six membered ring respectively.

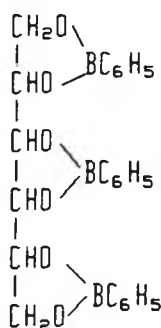

STRUCTURE 1

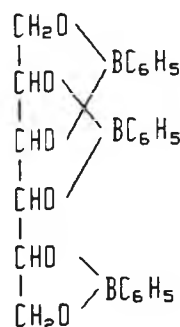

STRUCTURE 2

Several alkane diols were allowed to react with benzenboronic acid to determine any preference for ring size [2]. On reaction with benzenboronic acid; 2,3-butanediol, 1,3-butanediol and 1,4-butanediol formed distillable products in yields of 81, 88 and 71% respectively. Under similar experimental conditions 1,5

pentanediol gave no product. Thus formation of 5, 6 and 7 membered rings was possible but not an 8 membered ring. The percentage yields indicated that 6 membered rings appear to form more readily.

Boron has a close relationship to carbon, from which it differs by one nuclear charge. Boron can fit into organic compounds as a heteroatom as easily as nitrogen or oxygen [3]. The first compounds containing carbon-boron bonds date from 1860. These include triethylborane $(C_2H_5)_3B$, a spontaneously flammable liquid, and ethylboronic acid $C_2H_5B(OH)_2$, an air stable solid having a sweet taste. Boronic acids and esters are convenient laboratory reagents, generally stable in air, easy to manipulate and not particularly toxic. Therefore boron should be good starting point in examining new ways of linking a photosensitive group to PVA.

5.3 Synthesis Of Boronic Acids And Boronic Esters

Carbon-boron bonds are formed in processes which take advantage of the electrophilic character of tri co-ordinate boron. This is due to the presence and/or ready availability of the empty P orbital [4].

There are several convenient methods for the preparation of boronic acids and esters. The classical one is the reaction of Grignard reagents with trialkoxyborates (scheme 5.1) [5]. The Grignard reagent and the trimethylborate are added simultaneously to the flask and cooled to $-78^\circ C$ (dry

ice/acetone) with efficient stirring. If a boronic ester is desired, exchange of the hydroxy and alkoxy ligands is generally rapid and the equilibrium easily shifted by such techniques as azeotropic distillation.

Scheme 5.1: Preparation Of Boronic Acids Using Grignard Reagents With Trialkoxyborates



Arylgrignard reagents formed in the presence of borane-THF, at 0°C yield ArBH₃, which reacts with acid to yield ArB(OH)₂ (scheme 5.2) [6,25].

Scheme 5.2: Preparation Of Boronic Acids Using Grignard Reagents With Borane-THF Complex

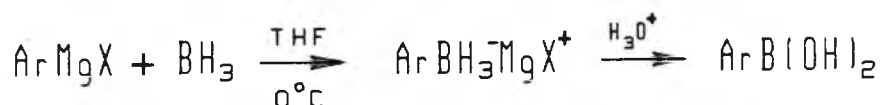

The preparation of boron containing Grignard reagents was attempted using iodo, bromo and chloro substituted benzene. Aryl iodides were eliminated because the yields of the corresponding aryl magnesium iodides were erratic. The Grignard reagents from aryl chlorides were difficult to prepare and so were subsequently abandoned. Fortunately, the aryl bromides were readily available and formed Grignard reagents in good yields. In the absence of excess BH₃, the monoaryl borohydride is quickly converted to diaryl, triaryl

and tetra-aryl boron derivatives. The use of a four fold excess of borane minimizes the formation of multiarylated boron derivatives by ensuring borane is present in sufficient amounts to react with the aryl magnesium bromide as it is formed.

However, low yields are obtained for the smaller alkyl groups and subsequent esterification is necessary to obtain the ester. Thus a useful variant of the classical approach uses an organolithium reagent and tri-isopropylborate (scheme 5.3) [7,28]. Addition of alkyl lithiums to tri-isopropylborate generally yields monoalkyl tri-isopropyl borate salts in nearly quantitative yields. Work up consists of the addition of anhydrous hydrogen chloride and the distillation of the propan-2-ol followed by the di-isopropylalkyl boronate.

Scheme 5.3: Preparation Of Boronic Esters Using Organolithium Reagent And Tri-isopropylborate



Boronic acids and boronic esters are generally prepared from Grignard or lithium reagents and trialkyl borates. However, the more recently discovered hydroboration of alkenes provides an alternative route for certain structures (scheme 5.4) [8,9]. Alkylhaloboranes are more inconvenient to make by classical routes and hydroboration makes them available as practical synthetic intermediates. Also hydroboration reactions can be carried out in the presence of many functional groups. By this method an ethylenic group is

reacted with excess diborane followed by alcoholysis of the BH₂ group. The stereochemistry of the hydroboration reaction corresponds to the direct addition of the B-H unit to a C=C group via a cyclic four centre transition state. Hydroboration involves an exclusive cis addition of the B-H bond. The preferred approach is to use borane that is already in the right oxidation state.

Scheme 5.4 : Hydroboration Of Ethylenic Double Bond To Produce A Cyclic Boronic Ester

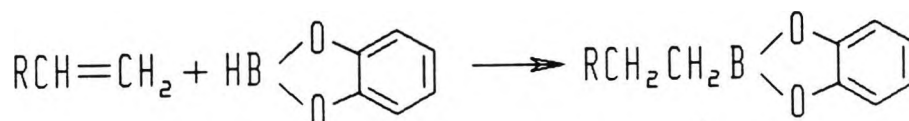

5.4 Synthetic Uses Of Boronic Acids And Their Esters

A review of the synthetic uses of boronic acids and esters is not appropriate for this thesis. However, it is important to note that due to the chemical stability of boronic acids and their esters and also the favourable steric properties of the esters make them excellent reagents for asymmetric synthesis as well as geometrically controlled olefin synthesis. The boron atom is small, only slightly larger than carbon and so can serve as a template for assembling carbon-carbon or carbon-heteroatom bonds with stereochemical sensitivity. When the stereodirected synthesis is completed, it is generally possible to replace or remove the boron [4,8,9,10 and 14].

5.5 Results And Discussion

Before tackling the synthesis of these styrylpyridiniumboronic acids a preliminary investigation into the effectiveness of modifying polyvinyl alcohol with boronic acids was carried out. The commercially available phenyl boronic acid was used for these experiments.

Homogeneous modification of polyvinyl alcohol with phenylboric acid was carried out in acidic, neutral and basic conditions using the procedure described in Chapter 2, (Table 5.1). It can be seen that from this experiment that under acidic conditions the boronic acid does not appear to stay in solution whereas under neutral or basic conditions, at lower per cent concentrations, homogeneous solutions can be obtained. It should be noted that in order to achieve a free flowing homogeneous solution much lower levels of grafting than in the styryl pyridinium modified PVA are necessary. This is probably due to the insolubility of these compounds in an aqueous environment. However the desired product, ie styrylpyridiniumboronic acid, will have much improved water solubility.

To investigate whether grafting actually occurred under these conditions solution 6, table 5.1, was treated with methanol in order to precipitate polyvinyl alcohol and the modified polyvinyl alcohol solids described previously. The alcohol was added slowly firstly to precipitate the polyvinyl alcohol and secondly to expel any water. The precipitate was filtered, washed with methanol and dried. A known weight of

modified polyvinyl alcohol was redissolved in H₂O and the UV spectrum of this solution obtained which corresponded to the UV spectrum of phenylboronic acid with the maximum at 265nm (fig 5.1). This is evidence that the phenylboronic acid grafts onto the PVA backbone under the conditions used.

Table 5.1: Homogeneous Modification Of PVA With Phenylboronic Acid

SOL	PVA SOLUTION	Phenylboronic acid (g)	CONDITIONS	COMMENTS
1	50g	0.5g	60°,5 hours,pH2	No solution or acetalisation achieved
2	50g	0.5g	RT ,5 hours,pH2	No solution or acetalisation achieved
3	50g	0.5g	60°,5 hour,neutral conditions	Uneven distribution,localised gelling
4	50g	0.5g	RT,5 hours,neutral conditions	Uneven distribution ,localised gelling
5	100g	0.1g	RT,5 hours,neutral conditions	Viscous homogeneous solution
6	100g	0.5g	RT,5 hours,neutral conditions	Viscous homogeneous solution
7	100g	1g	RT,5 hours,neutral conditions	Uneven distribution,localised gelling
8	50g	0.1g	RT,5 hours,pH 10	Homogeneous solution but no increase in viscosity

Fig 5.1: UV Spectrum OF PVA Modified With Phenylboronic Acid In Aqueous Solution

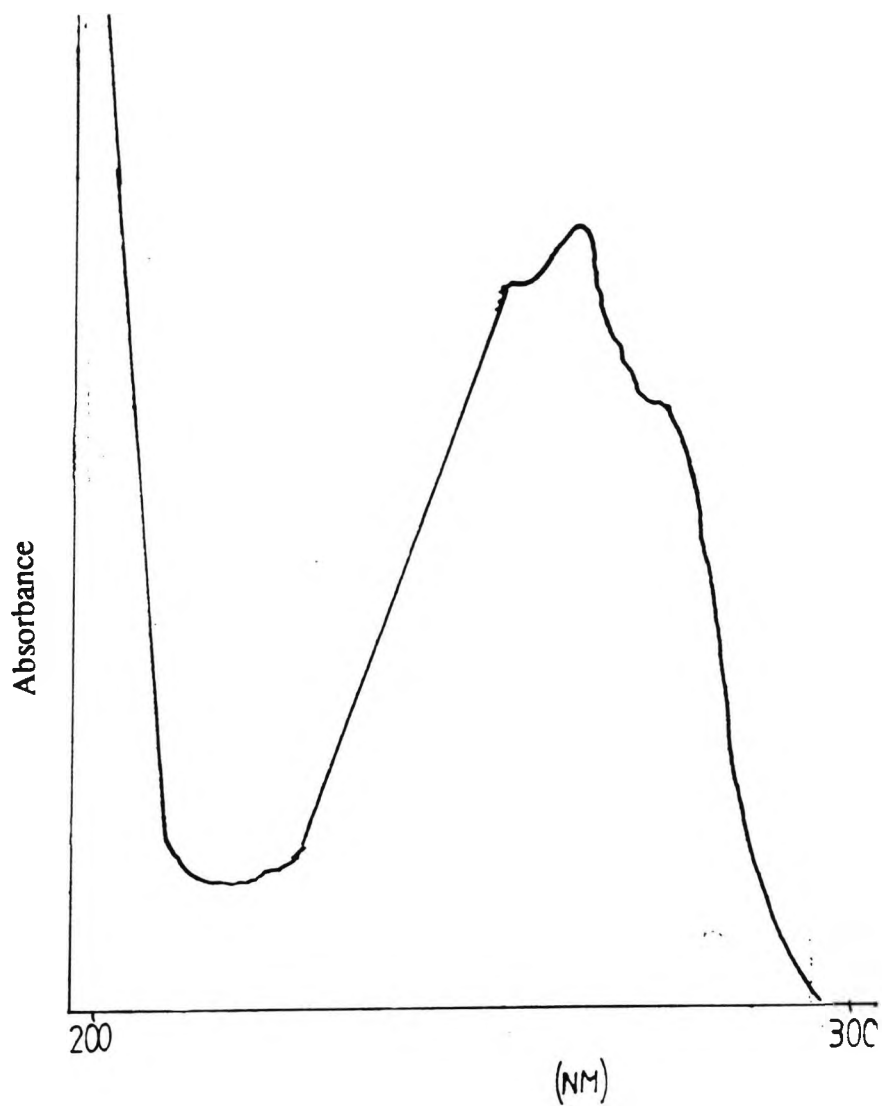

The modification of polyvinyl alcohol by the heterogeneous method as described in Chapter 3 was attempted with varying methanol:water ratios (table 5.2). The washed, filtered and dried modified polyvinyl alcohol was redissolved in H₂O and the UV spectrum of each solution taken. The UV spectra confirmed that the polyvinyl alcohol backbone was modified by the phenylboronic acid.

Table 5.2: Methanol:H₂O Ratio For Heterogeneous Grafting

Methanol (ml)	H ₂ O (ml)
10.0	10.0
15.0	5.0
17.5	2.5

It was not possible to obtain, at this time, accurate figures for the percentage of grafting for either the homogeneous or heterogeneous grafting procedures because of the great difficulty encountered when precipitating the modified polyvinyl alcohol from aqueous solution. On precipitation a string-like solid form which proved difficult to redissolve in water unlike the styrylpyridinium modified polyvinyl alcohol which was very easy to redissolve. This is because the styrylpyridinium salt is much more water soluble than phenylboronic acid. However at this stage it is enough to

show that boronic acids can be grafted onto polyvinyl alcohol.

So far all styrylpyridinium salts have been prepared by both the Perkin And Knoevenagel condensation reactions. To prepare boronic acid derivatives of these salts a different synthetic route was sought.

The first synthetic scheme for the production of styrylpyridiniumboronic acids to be investigated involved the preparation of 4-tolylboronic acid followed by the bromination of the alkyl group and the preparation of a phosphonium salt in order to carry out a Wittig reaction with 4-pyridinecarboxaldehyde to yield a styryl pyridinium boronic acid [15]. The preparation of 4-tolylboronic acid was achieved by the formation of the tolyl Grignard reagent in the presence of BH_3 -THF complex as described in scheme 5.5.

Scheme 5.5: Preparation Of 4-Tolylboronic Acid Using A Grignard Reagent And BH_3 -THF Complex

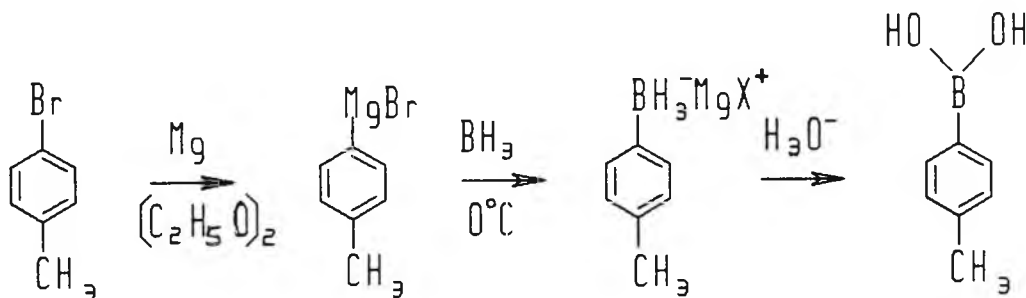

The bromination of the allylic or benzylic carbon atom is usually carried out by using N-bromosuccinimide (NBS) [16].

It is a free radical chain process in which molecular bromine is involved in the cycle of chain propagating reactions by abstracting a hydrogen atom from the substrate. The reaction is very sensitive to free radical initiators and inhibitors and indeed does not proceed at all unless at least a trace of initiator is present. The reaction mechanism is as follows (scheme 5.6).

Scheme 5.6: Mechanism Of Free Radical NBS Reaction

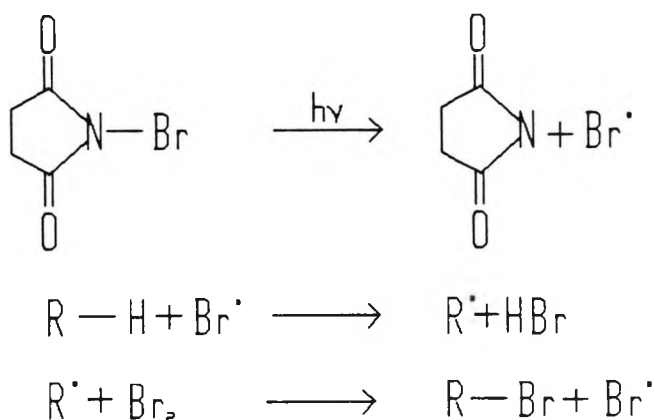

The reaction is selective at the allylic or benzylic position because initiation involving the bromine atom having a lower reactivity preferentially leads to the resonance-stabilised allylic or benzylic free radical. The reaction is carried out in non-polar solvents in which N-bromosuccinimide is insoluble. Thus only a very low concentration of Br_2 or HBr is present in the heterogeneous mixture so that other reactions such as addition to the double bond are avoided. This reaction is called the Wohl-Ziegler bromination. It was considered prudent to optimize the conditions using commercially available toluene.

The bromination of toluene was carried out in carbon tetrachloride with benzoyl peroxide as the initiator. After twenty hours irradiation at 254nm the product was examined by nmr. An examination of the chemical shifts revealed that the unsubstituted (2.4ppm), monosubstituted (4.4ppm) disubstituted (6.75ppm) allylic groups are present. Also there are possibly some trisubstituted groups present but you would not observe this by nmr. From the nmr integrals it was calculated that the ratio of products present was as follows:-

toluene : benzylbromide : benzaldehyde : tribromomethylbenzene

1.5 : 2.5 : 1.8 : 1

In order to decrease the reaction time, the reaction was carried out under reflux. Also since the reaction does not stop at the monobromination stage, the products were analysed every 15 minutes by nmr to find the highest benzylbromide:toluene ratio. Optimum reaction conditions would tolerate the presence of toluene as this would not interfere with the preparation of a phosphonium salt and subsequent Wittig reaction whereas the di and tri bromosubstituted products would take part in the Wittig reaction. By monitoring, using nmr, it was discovered that after 2 hours the reaction mixture gives a maximum benzylbromide:toluene ratio with negligible benzaldehyde and benzyltribromide (Table 5.3).

Table 5.3: The Ratio Of Toluene:Benzyl Bromide From NMR Monitoring Of The Bromination Of Toluene Under Reflux In CCl₄ With Benzoyl Peroxide And NBS.

REACTION TIME (MINS)	TOLUENE RATIO	BENZYL BROMIDE RATIO
15	0.61	1.0
30	0.30	1.0
45	0.22	1.0
60	0.16	1.0
120	0.14	1.0

The bromination of 4-methylbenzeneboronic acid did not proceed as easily. The 4-methylbenzeneboronic acid did not dissolve in cold carbon tetrachloride. It did dissolve in hot carbon tetrachloride however. The reaction was carried out under similar conditions as the bromination of toluene but after two hours the ratio of 4-bromomethylbenzeneboronic acid:4-methylbenzeneboronic acid was approximately 1:1. This is very much slower than the bromination of toluene. Again after two hours bromination negligible amounts of di and trisubstituted products are formed. The bromination reaction was repeated using twice the amount of benzoyl peroxide. This increased 4-bromomethylbenzeneboronic acid:4-methylbenzeneboronic acid ratio

drastically to 1:0.1 but with an appreciable amount of benzaldehydeboronic acid being formed. The 4-bromomethylbenzeneboronic acid:4-benzaldehydeboronic acid ratio being 1:0.28.

It is suggested that the bromination of 4-bromomethylbenzeneboronic acid is very much slower than that of toluene due to its poor solubility in CCl_4 . It was considered an ester of 4-methylbenzeneboronic acid would have better solubility in CCl_4 and hence allow the bromination reaction to go under the same conditions as for toluene. This reaction was carried out in excess methanol or ethanol under reflux with water being continually removed as the reaction proceeded. Mass spectral analysis of the white precipitates formed in each case revealed a molecular ion of 354. Methylation of 4-methylbenzeneboronic acid by diazomethane was also attempted, yet again mass spectral analysis showed a molecular ion of 354. This value corresponds to the following structure:-

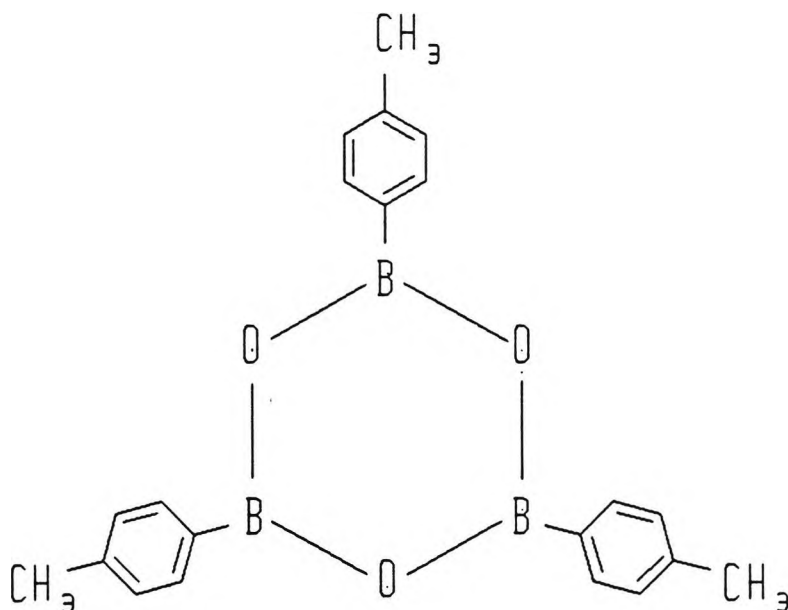

Such anhydride formation occurs by heating (110°C for 8 hours) or under reduced pressure. Electron diffraction studies for methylboronic anhydride have pointed to a planar six membered ring structure with alternating boron and oxygen atoms, each methyl group being bonded to a boron atom and in the plane of the ring [17]. The 4-methylbenzeneboronic acid was probably converted to its anhydride during purification procedures or alternatively under the acid conditions of esterification or alternatively during bromination in anhydrous solvents [18].

In a Wittig reaction an aldehyde or ketone is reacted with a phosphorane or a phosphorous ylide [15]. These ylides are prepared by treating phosphonium salts with base. The phosphonium salts themselves being prepared by the interaction of an alkyl halide with a phosphine derivative (scheme 5.7).

Scheme 5.7: Interaction Of A Phosphine Derivative With An Alkyl Halide

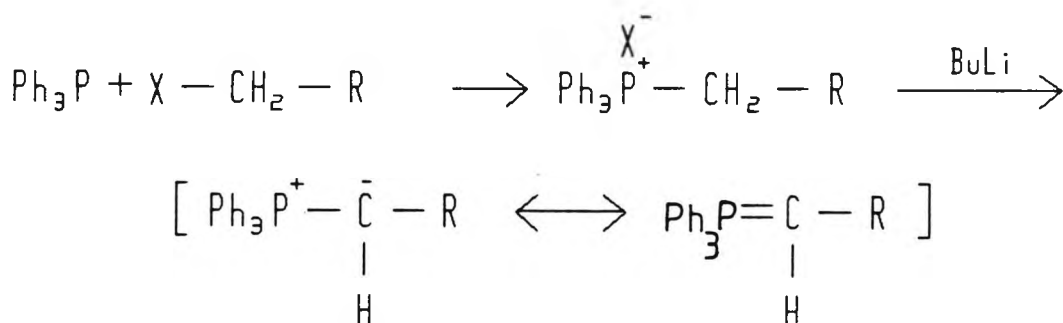

The Wittig reaction is very general with the position of the new double bond always being certain (scheme 5.8).

Scheme 5.8: The Wittig Reaction

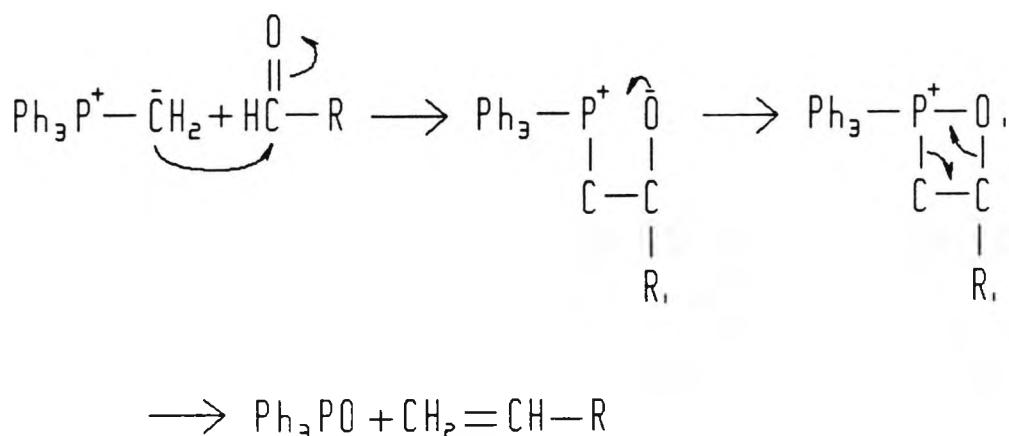

To carry out a Wittig reaction on the 4-bromobenzylboronic acid, the 4-bromobenzylboronic acid and triphenylphosphine were placed in a conical flask containing toluene for 1 hour. A white precipitate was formed which was assumed to be the phosphonium salt. The addition of 4-pyridinecarboxaldehyde to the phosphonium salt in the presence of sodium ethoxide failed and after several attempts was abandoned in favour of another approach. It should be noted that the reaction may have failed in the preparation of the phosphonium salts since this product was never isolated.

The second synthesis approach involved the preparation of bromo substituted styrylpyridines, followed by the introduction of the boron containing group, and finally to increase the water solubility by the quaternisation of the nitrogen by dimethyl sulphate.

The bromo substituted 2- and 4-styrylpyridines were prepared by condensing 4-bromobenzaldehyde with 2- or 4-picoline in a

mixed solvent pair of acetic acid and acetic anhydride (scheme 5.9).

Scheme 5.9: Condensation Of 4-Bromobenzaldehyde With 2- Or 4-Picoline

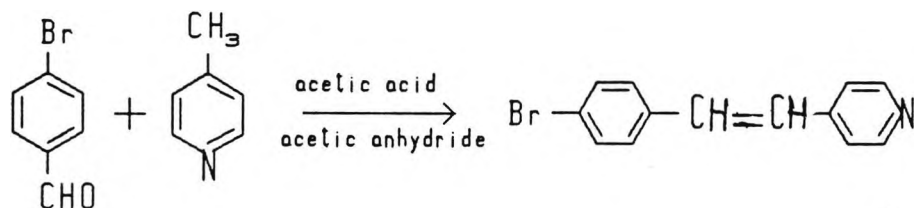

The modification of 2- or 4-[2-(bromophenylethenyl)]pyridine was first attempted by reacting the corresponding Grignard reagent with borane-THF complex at 0°C (scheme 5.10).

Scheme 5.10: Preparation Of Styrylpyridineboronic Acid Using Grignard Reagent And BH₃-THF Complex

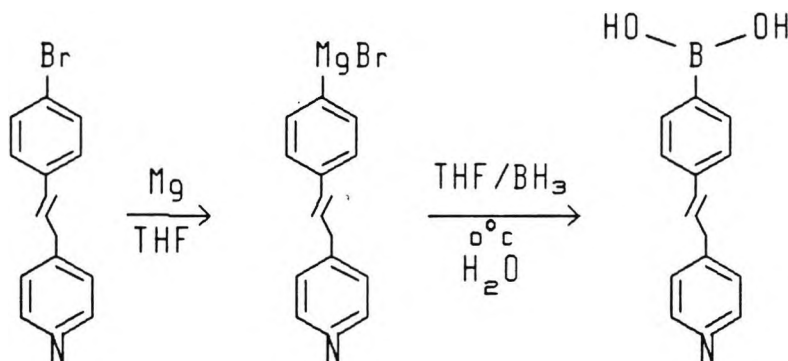

The generation of the Grignard intermediate appeared to proceed as normal but on addition of the borane-THF complex a white precipitate formed which was identified as boric acid. It is necessary to treat the Grignard reagent with the BH₃-THF complex under a nitrogen blanket such that if the nitrogen blanket was not continuous then the borane could

have been hydrolysed by atmospheric moisture to boric acid.

As described in section 5.3 a variant to this classical approach in producing boronic acids and esters is the use of tri-isopropyl borate in THF at -78°C . It was considered prudent to get experience of the reaction on a commercially available material before using the bromo substituted styrylpyridines already prepared. The Grignard reagent prepared from 4-bromoanisole was added drop wise to a stirred solution of tri-isopropylborate in THF under N_2 at -78°C . The solution was hydrolysed with aqueous HCL and the products extracted into diethyl ether (scheme 5.11).

Scheme 5.11: Preparation Of 4-Methoxybenzeneboronic Acid Using A Grignard Reagent And Tri-isopropylborate

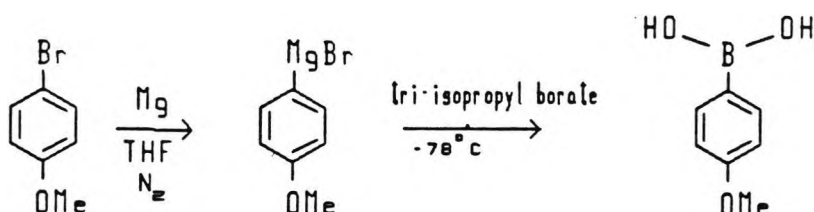

A similar reaction was carried out using 4-[2-(bromophenylethenyl)]pyridine. Mass spectral analysis of the product formed showed that a styrylpyridineboronic acid had been formed. However the yield was very low.

Before giving reasons for the possible failure of this reaction a very important point of boronic acid chemistry which has been overlooked must be reviewed. The conversion of free boronic acid to its anhydride occurs very easily in

anhydrous solvent [18]. The presence of this boronic anhydride and the consequences which may result from it should be considered in any reaction which entails the use of anhydrous conditions. Kinney et al have shown that anhydrides of these boronic acids tend to exist in a trimeric form [26,27]. This is all the more pertinent to the synthesis of styrylpyridiniumboronic acids in view of the work carried out by Burg in the forties and then Snyder in the fifties and sixties [18,19,20,21,29,30,31,32,33].

Burg discovered that methane boronic anhydride forms 1:1 complexes with amines and ammonia, having the following structure:-

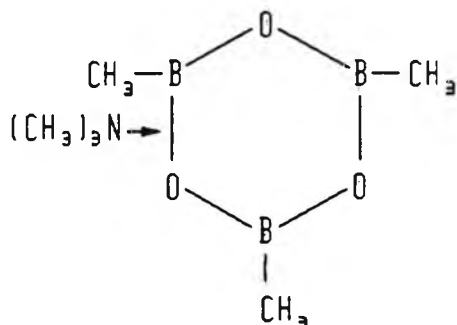

Snyder et al found 1:1 complexes of pyridine and benzenboronic acid to have a microanalytical composition to be in agreement with the following structure:-

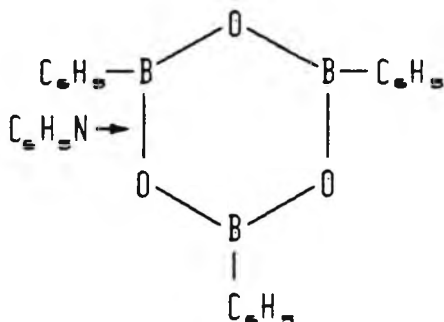

The fact that only one nitrogen atom can interact with the anhydride molecule suggests that in the bonding the entire boroxole ring functions as an electron deficient unit. These adducts are crystalline materials of low solubility.

Bearing these points in mind we can now reconsider the process for the formation of the Grignard reagent of 4-[2-(4-bromophenylethenyl)]pyridine with tri-isopropylborate. As the reaction proceeds some of the newly formed styrylpyridiniumboronic acid may be converted to the styrylpyridiniumboronic anhydride with the release of water. This water could hydrolyse the tri-isopropylborate to isopropanol and boric acid thus reducing the amount of active reagents. Alternatively some of the bromostilbazole compound could have formed a complex similar to the ones described by Snyder. A third scenario could be the formation of a dative nitrogen to boron bond between the bromostilbazole and tri-isopropylborate.

A variation on the Knoevenagel reaction where the picolinium salt is condensed with formylbenzeneboronic acid would overcome several of the difficulties met in the previous synthetic routes [34,35]. Firstly, quaternisation of the nitrogen would eliminate any interaction of the nitrogen with the electron deficient boron. Hence the formation of formylbenzeneboronic acid anhydride could be easily tolerated. Also the boron containing group is present throughout the whole synthetic sequence. Finally, the product is in a form which can be used to modify polyvinyl alcohol whereas previous schemes demanded the quaternisation of the

nitrogen after the introduction of the boronic acid group.

The Sommelet reaction is a process whereby aldehydes are produced from alkyl or arylmethyl halides by the action of hexamethylenetetramine i.e. the same reagent that serves to convert amines into aldehydes [22-24]. It was in this combined form that the reaction was discovered by Sommelet. When a halide is used as the starting material the Sommelet reaction proceeds in three stages (scheme 5.12). Firstly, the formation of a hexaminium salt, followed by hydrolysis of this salt to an amine and its methylene derivative and finally formation of an aldehyde. In a hydroxylic medium the hexaminium salts are hydrolysed to products, the nature of which are pH dependent. Strong acids produce salts of primary amines whereas alkali or ammonia give the corresponding methylene amines; and at intermediate pHs an equilibrium mixture of the two is obtained. At these intermediate pHs particularly at about pH 3-6.5, the mixture reacts with hexamine to yield an aldehyde.

Scheme 5.12: Schematic View Of The Sommelet Reaction

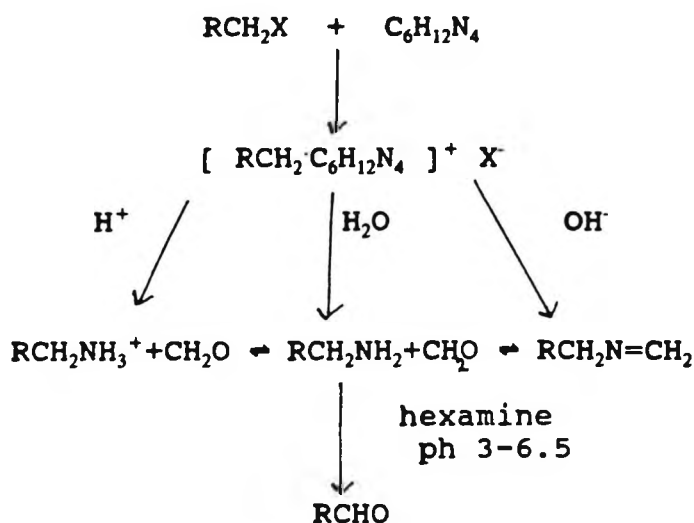

The most convenient procedure consisted of brominating 4-methylbenzeneboronic acid in chloroform solution and treating the bromomethyl derivative in situ with hexamethylenetetramine. The bromination reaction was monitored by nmr, the monobromomethyl derivative was present in 90% yield before any appearance of a dibromomethylene group. Addition of hexamethylenetetramine, the Sommelet reaction proper, allowed 4-formylbenzeneboronic acid to be produced in yields similar to those described in the literature (scheme 5.13).

Scheme 5.13: Preparation Of Formylbenzeneboronic Acid

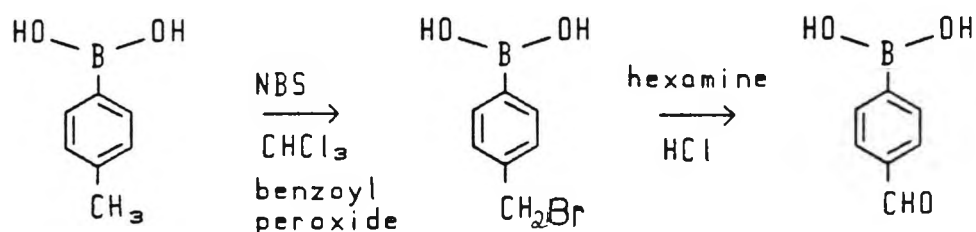

The 4-formylbenzeneboronic acid was refluxed with 4-picolinium salt in methanol with a catalytic amount of piperidine. On cooling a yellow product, identified as 1-methyl-4-[2-(4phenylboronic acid)ethenyl]pyridinium methosulphate, precipitated out in good yields (scheme 5.14).

5.6 Conclusions

1 Methyl-4-[2-(4phenylboronic acid)ethenyl]pyridinium methosulphate has been prepared and the $B(OH)_2$ group shown to be suitable linking group for styrylpyridinium salts to PVA without an acid catalyst. This can be extended to a whole range of aldehydes especially those which are sensitive to pH.

References

1. H. Kuivila, A. Keough and E. Soboczenki, *J. Org. Chem.*, **19**, 781 (1954)
2. J.M. Sugihara and C.M. Bowman, *J. Amer. Chem. Soc.*, **80**, 2443 (1958)
3. I. Exner and V. Jehlicka, *Coll. Czech. Chem. Commun.*, **37**, 2169 (1972)
4. D.S. Matteson, "The Chemistry Of The Metal-Carbon Bond, vol 4, (Eds. F. Hartley and S. Patia)", John Wiley And Sons, 1987
6. G.W. Kabalka, U. Sastry And K.A.R. Sastry, *J. Organometallic Chem.*, 259, 269 (1983)
7. M.E. Jung and Y.H. Jung, *Tett. Letts.*, **29**, 21, 2517 (1988)
8. D.S. Matteson and J.G. Shdo, *J. Org. Chem.*, **29**, 2742 (1964)
10. D.S. Matteson and R.J. Moody, *Organometallics*, **1**, 20 (1982)
11. E. Khotinsky and M. Mekimed, *Chem. Ber.*, **42**, 3090 (1909)
12. D.S. Matteson and J.D. Liedtke, *J. Amer. Chem. Soc.*, **87**, 1526 (1965)
13. D.S. Matteson, *Acc. Chem. Res.*, **21**, 294 (1988)
14. A. Suzuki, *Acc. Chem. Res.*, **15**, 178 (1982)
15. G. Wittig, *Pure Appl. Chem.*, **2**, 245 (1964)
16. S.H. Pine, J.B. Hendrickson, D.J. Cram and G.S. Hammond, "Organic Chemistry", McGraw Hill, N.Y., 1980
17. W. Gerrard, "The Organic Chemistry Of Boron", Academic Press, London, 1961
18. H.R. Snyder, M.S. Konecky and W.J Lennarz, *J. Amer. Chem. Soc.*, **80**, 3611 (1958)
19. A.B. Burg, *J. Amer. Chem. Soc.*, **62**, 2228 (1940)
20. H.E. Dunn, J.C. Catlin and H.R. Snyder, *J. Org. Chem.*, **33**, 4483 (1968)
21. J.C. Catlin and H.R. Snyder, *J. Org. Chem.*, **34**, 1660 (1969)
22. S.J. Angyl, "Organic Reactions, Vol 8", John Wiley And

Sons, N.Y., 1954

23. S.J. Angyal and R.C. Rassack, J. Amer. Chem. Soc., 2700 (1949)
24. S.J. Angyal, P. Morris, R.C. Rassack and J.A. Waterer, j. Chem. Soc., 2704 (1949)
25. G.W. Kabalka, R.S. Varma, Y. Gai and R.M. Baldwin, Tett. Letts., 27, 33, 3843 (1986)
26. C.R. Kinney and D.F. Pontz, J. Amer. Chem. Soc., 58, 196 (1936)
27. C.R. Kinney and D.F. Pontz, J. Amer. Chem. Soc., 58, 197 (1936)
28. H.C. Brown and T.E. Cole, Organometallics, 2, 1316 (1983)
29. J.C. Catlin and H.R. Snyder, J. Org. Chem., 34, 6, 1664 (1969)
30. W. Cummings, C.S. Cox and H.R. Snyder, J. Org. Chem., 34, 6, 1669 (1969)
31. J.C. Catlin and H.R. Snyder, J. Org. Chem., 34, 6, 1660 (1969)
32. H.R. Snyder, J.A. Kuck and J.R. Johnson, J. Amer. Chem. Soc., 60, 105 (1938)
33. J.R. Kuszewski, W.J. Lenners and H.R. Snyder, J. Org. Chem., 33, 12 (1968)
34. H.R. Snyder, A.J. Reedy and W.J. Lennarz, J. Amer. Chem. Soc., 80, 835 (1958)
35. A. Hoffman and W. Thomas, J. Amer. Chem. Soc., 81, 580 (1959)

CHAPTER 6

Experimental

6.1 Instrumentation

6.1.1 IR Spectra

These were recorded as nujol mulls or KBr discs using a Perkin Elmer 983G spectrophotometer. The FT-IR spectra were run on a Bio-Rad FTS-60 spectrometer.

6.1.2 UV/Vis Spectra

These spectra were recorded using a Philips PU 8720 UV/Vis scanning spectrophotometer. Diffuse reflectance spectra were achieved using an integrating sphere attachment on a Perkin-Elmer Lambda 5.

6.1.3 ¹H NMR Spectra

These were measured on a Jeol PMX 60si 60 NMR spectrometer, using an external lock, tetramethylsilane (TMS) as the internal standard and deuteriochloroform, deuterioacetone and deuterium dioxide as the solvents. The following abbreviations are used in the spectral interpretations: s-singlet, d-doublet, t-triplet, q-quartet, m-multiplet.

6.1.4 Fluorescence Spectra

These were recorded as aqueous solutions or as thin films coated on paper using a drawbar on a Perkin Elmer MPF-4 spectrofluorimeter and are uncorrected. Where applicable

spectrophotometric solvents were used and solvent blanks recorded, in each case, to ensure that they did not emit significantly over the wavelength ranges being monitored. Solutions were made up in a 1cm path length quartz, rectangular, fluorimeter cell to an OD of 0.1 at the excitation wavelength. Polymer samples in film form were studied in the manner developed by J.F McKellar and P.H. Turner [1,2]. The films were placed at a 45° angle to the beam of excitation light in order to minimise scattered light from entering the emission monochromator.

6.1.5 Mass Spectra

Measurements were carried out by Mr. C. Whitehead, using a Kratos MS30 Eleactron Impact Mass Spectrometer linked to a Kratos DS 50 data system. Samples were run at 70ev.

6.1.6 Elemental Analysis

CHN analysis were performed by Mr. A. Murphy using a Carlo Erba Model 1106 Elemental Analyser.

6.1.7 Melting Points

Melting points were recorded using a Griffin melting point apparatus. Melting points are uncorrected.

6.1.8 UV Curing

UV curing of thin films was effected with a Colordry unit which housed a medium pressure Hg lamp mounted on a conveyor belt system. The conveyor belt speed was set at 12m/min. Photosensitive solutions were cured as thin films on screens (HDW mesh, 2+2) on site at Sericol Group Ltd, Broadstairs

using a Platemaker exposure unit. The Platemaker exposure unit housed a 5 KWatt lamp. All samples, unless stated otherwise were irradiated for 200 light units. A light unit in a new lamp is equivalent to irradiation for 1 second, as the lamp deteriorates with age the time of irradiation for 1 light unit gets longer to compensate for any weakening of the lamp.

6.1.9 Viscosity Measurements

All viscosity measurements were carried out using a Brookefield viscometer (model RVI).

6.2 Sources Of Chemicals

The stated chemicals were obtained from the following chemical companies:-

Aldrich Chemical Co. Ltd.

Benzoyl peroxide, 4-bromobenzaldehyde, 4-bromotoluene, cinnamaldehyde, 4-cyanocinnamaldehyde, 3-(2-furyl)acrolein, phenylboronic acid, 2-picoline, 4-picoline, 4-pyridinecarboxaldehyde, triisopropylborate.

BDH Chemicals Ltd.

N-Bromosuccinimide

Goss Scientific Instruments

Acetone-d₆, chloroform-d₁, deuterium oxide

Lancaster Synthesis

Formylmethylenetriphenyl phosphorane, 4-

methoxycinnamaldehyde, 4 - methylbenzeneboronic acid, tolualdehyde.

PVA powder (various grades) were supplied by Sericol Group Ltd., Broadstairs.

6.3 Preparation Of Materials

6.3.1 Preparation Of 13% Polyvinyl Alcohol Solution

Commercially available polyvinyl alcohol 86%-89% hydrolysis, MW 115,214 dp 2350) (65g) was slowly added to water (500ml) which was stirred using a mechanical stirrer. The stirred solution was heated to 90°C and then allowed to cool to room temperature. Biocide (0.045 by weight) was added to prevent fungal growth [3].

6.3.2 Preparation Of 1-Methyl-4-[2-(4-formylphenyl)ethenyl]pyridinium Methosulphate (4SbO salt)

To a round bottom flask containing methanol (15ml) and dimethyl sulphate (5.7ml), 4-picoline (7.12ml, 0.08mol) was added dropwise, making sure that the temperature in the reaction vessel did not exceed 50°C. The reaction mixture was left to stand overnight. Terephthaldehyde (16.5g, 0.12 mol) was added and dissolved by heating, followed by the addition of piperidine (0.6ml). This mixture was then heated under reflux for 3 hours. On cooling to 40°C any precipitate was filtered off: 1,4-bis[2-(4-pyridyl)ethenyl]benzene. Isopropanol (22.5ml) and acetone (7.5ml) were added to the solution which was left standing overnight. Yellow crystals

were collected by filtration, washed with acetone and recrystallised from a methanol/water solvent pair (83% yield).

Melting point 220-230°C (lit. val. 213°C) [4]

IR (KBr disc) 3033, 2834, 2744, 1691, 1562, 1518, 1335, 1099, 1064, 760 and 618cm⁻¹.

UV (H₂O) λ_{max} 342nm, ε 44,000 l mol⁻¹cm⁻¹

NMR (D₂O) ppm; 9.8 (1H, s); 8.65-8.45 (2H, m); 8.10-7.05 (8H, m); 4.25 (3H, s) and 3.65 (3H, s)

Mass Spectral Analysis m/e 224; m/e 209

C₁₆H₁₇NO₅S theory %C, 57.30; %H, 5.10; %N, 4.17; found %C, 56.98; %H, 4.97; %N, 4.09.

6.3.3 Preparation Of 1-Methyl-2-[2-(4formylethenyl)phenyl]pyridinium methosulphate (2SbO salt)

To a round bottom flask containing IMS (1ml), butan-2-ol (9ml) and dimethylsulphate (5.6ml), 2-picoline (5.8ml, 0.6mol) was added dropwise making sure the temperature did not exceed 40°C. The mixture was allowed to stand overnight. Terephthaldehyde (9.5g, 0.7mol) and butan-2-ol (40ml) was added and the reaction mixture was heated to 80°C. Piperidine (6ml) was added dropwise and the reaction temperature maintained at 80°C for 3 hours. Allow to cool and add acetone to precipitate the crude product. Recrystallise from 95:5 methanol/water mixed solvents (yield 80%).

Melting point 151-152°C (lit. val. 151-152°C) [4]

IR (KBr disc) 3392, 2920, 2854, 1690, 1625, 1415, 1570, 1517, 1467, 1065 and 774cm⁻¹.

UV (H₂O) λ_{max} 336nm, ε 32300l⁻¹mol⁻¹cm⁻¹

NMR (D₂O) ppm; 9.9 (1H, s); 8.85-8.6 (2H, m); 8.13-7.56 (8H, m); 4.4 (3H, s) and 3.8 (3H, s).

Mass Spectral Analysis m/e 209

C₁₆H₁₇NO₃S theory %C, 57.30; %H, 5.10; %N, 4.17: found %C, 56.98; %H, 4.97; %N, 4.09.

6.3.4 Preparation Of 4-[2-(Phenyl)ethenyl]pyridine

A mixture of benzaldehyde (10g, 0.1M) and 4-picoline (9.3g, 0.1M) was heated in a mixed solvent of acetic anhydride 6(10.2g) and acetic acid (6g) under reflux overnight in the presence of a catalytic amount of methane sulphonic acid. The reaction mixture was acidified with 100ml of a 10% HCl solution and then neutralised with NaOH solution. A precipitate was formed, filtered and recrystallized from ethylene acetate (yield 60%).

Melting point 115-118°C (lit. value 128°C) [5]

IR (KBr disc) 3024, 1634, 1590, 1495, 990, 755, 731 and 6921cm⁻¹.

UV (CH₃OH) λ_{max} 307nm, ε 33000 l⁻¹mol⁻¹cm⁻¹

NMR (CD₃COCD₃) ppm; 8.84-8.64 (2H, M); 7.92-7.66 (8H, M); 7.32 (1H, D).

Mass Spectral Analysis m/e 181; m/e 180

C₁₃H₁₁N theory %C, 86.15; H, 6.12; N, 7.73: found %C, 85.88; H, 6.14; N, 7.69.

6.3.5 Preparation Of 2-[2-(Phenyl)ethenyl]pyridine

A mixture of benzaldehyde (10.6g, 0.1M) and 2-picoline (9.3g, 0.1M) was heated in a mixed solvent of acetic acid (6g) and acetic anhydride (10.2g) under reflux overnight in the presence of a catalytic amount of methane sulphonic acid. The reaction mixture was acidified with 100ml of a 10% HCl solution and then neutralised with NaOH solution. A precipitate was formed, filtered and recrystallised from ethyl acetate (yield 30%).

Melting point 75°C (lit. val. 90°C) [5]

IR (KBr disc) 3034, 1633, 1597, 1581, 1558, 1494, 983, 779, 737 and 690 cm⁻¹.

UV (CH₃OH) λ_{max} 309nm, ε 25000 l mol⁻¹cm⁻¹

NMR (CD₃COCD₃) ppm; 8.8-8.6 (1H, M); 7.88-7.04 (10H, M).

Mass Spectral Analysis m/e 181; m/e 180

C₁₃H₁₁N theory %C, 86.15; H, 6.11; N, 7.72: found %C, 85.60; H, 6.04; N, 7.45.

6.3.6 Preparation Of 1-Methyl-4-[2-(phenyl)ethenyl]pyridinium methosulphate

4-[2-(Phenyl)ethenyl]pyridine (1g, 0.006M) was dissolved in methanol. Dimethyl sulphate (1g, 0.008M) was added slowly and the reaction mixture was allowed to stand overnight. On

cooling a yellow precipitate was formed. The precipitate was filtered and over dried (yield 95%).

Melting point 168°C

IR (KBr disc) 3050, 2965, 1640, 1600, 1575, 1520, 1500, 1480, 1450, 1075 and 840cm⁻¹.

UV (H₂O) λ_{max} 341nm, ε 34,00 l_{mol}⁻¹cm⁻¹

NMR (D₂O) ppm; 8.14 (2H, d); 7.62 (2H, d); 7.52-7.22 (6H, m); 6.86 (1H, d); 3.96 (3H, s) and 3.76 (3H, s)

C₁₅H₁₇NSO₄ theory %C, 58.62; H, 5.57; N, 4.56:

found %C, 57.99; H, 5.37; N, 4.49.

6.3.7 Preparation Of 1-Methyl-2-[2-(phenyl)ethenyl]pyridinium methosulphate

2-[2-(phenyl)ethenyl]pyridine (1g, 0.006M) was dissolved in methanol. Dimethyl sulphate (1g, 0.008M) was added slowly and the reaction mixture was allowed to stand overnight. On cooling a yellow precipitate was formed. The precipitate was filtered and oven dried (yield 90%).

Melting point 125°C

IR (KBr disc) 3050, 2965, 1640, 1600, 1575, 1520, 1500, 1480, 1075 and 840cm⁻¹.

NMR (DMSO) ppm; 9.24-7.49 (11H, m); 3.51 (3H, s) and 2.16 (3H, s)

C₁₅H₁₇NSO₄ theory %C, 58.62; H, 5.57; N, 4.56:

found %C, 58.02; H, 5.27; N, 4.60.

6.3.8 Preparation Of 4-[2-(4Methylphenyl)ethenyl]pyridine

A mixture of tolualdehyde (12g, 0.1M) and 4-picoline (9.3g, 0.1M) was heated in a mixed solvent of acetic acid (6ml) and acetic anhydride (13ml) under reflux overnight in the presence of a catalytic amount of methane sulphonic acid. The hot reaction mixture was combined with 150cm³ of 1 mol/cm³ HCl and left to stand for 1 hour and then neutralised with NaOH solution. A precipitate was formed, filtered and recrystallised from ethyl acetate (95% yield)

Melting point 145-150°C (lit. val. 157°C) [5]

IR (KBr disc) 2924, 2854, 1630, 1588, 1511, 1461, 839 and 822cm⁻¹.

UV (CH₃OH) λ_{max} 307nm, ε 33000 l_{mol}⁻¹cm⁻¹

NMR (CDCl₃) ppm; 8.43-8.23 (2H, m); 7.33-6.5 (8H, m) and 2.1 (3H, s).

Mass spectral Analysis m/e 195; m/e 180

C₁₄H₁₃N theory %C, 86.11; %H, 6.71; %N, 7.17:

found %C, 85.85; %H, 6.63; %N, 7.13

6.3.9 Preparation Of 1-Methyl-4-[2-(4-bromophenyl)ethenyl]pyridinium methosulphate

To a round bottom flask containing methanol (2.5 ml) and dimethyl sulphate (1ml, 0.01M), 4-picoline (0.9ml, 0.01M) was added dropwise, making sure that the temperature in the reaction vessel did not exceed 50°C. The reaction mixture was

left standing overnight. Bromobenzaldehyde (1.85g, 0.01M) was added, followed by the addition of piperidine (0.6ml). This mixture was heated under reflux for 3 hours. The majority of the solvent was removed under reduced pressure. On standing a fine yellow powder precipitated. The yellow powder was recrystallised from ethyl acetate to yield the desired product (60% yield).

Melting point 250-255°C

IR (KBr disc) 3046, 1644, 1624, 1584, 1519, 1469, 986, 845, 734 and 576cm⁻¹.

NMR (D₂O) ppm; 8.57-8.33 (2H, m); 7.83-7.6 (2H, m); 7.46-6.67 (6H, m); 4.3 (3H, s) and 3.9 (3H, s)

Mass Spectral Analysis m/e 261; m/e 259

C₁₅H₁₆NO₃SBr theory %C, 46.64; %H, 4.17; %N, 3.62:

found %C, 46.42; %H, 3.98; %N, 3.63.

6.3.10 Preparation Of 4-[2-(4Bromophenyl)ethenyl]pyridine

A mixture of 4-bromobenzaldehyde (2g, 0.01M) and 4-picoline (1g, 0.01M) was heated under reflux in a mixed solvent pair of acetic anhydride (5ml) and acetic acid (2.5ml) for 5 hours. After cooling the majority of solvent was removed under reduced pressure. On cooling, a yellow solid precipitated out of the remaining solvent (yield 60%).

Melting point 156°C (lit. val. 158°) [6]

IR (KBr disc) 3026, 1632, 1593, 1582, 1481, 1214, 1101, 825 and 704cm⁻¹.

NMR (CD₃OCD₃) ppm; 8.7-8.5 (4H, m); 7.7-7 (6H, m)

Mass Spectral Analysis m/e 261; m/e 259 and m/e 180

C₁₃H₁₀NBr theory %C, 60%; %H, 3.84: found %C, 59.86; %H, 3.92.

6.3.11 Preparation Of 2-[2-(4Bromophenyl)ethenyl]pyridine

A mixture of 4-bromobenzaldehyde (2g, 0.01M) and 2-picoline (1g, 0.001M) was heated under reflux in a mixed solvent pair of acetic anhydride (5ml) and acetic acid (2.5ml) for 5 hours. After cooling the majority of solvent was removed under reduced pressure. On cooling, a yellow solid precipitated out of the remaining solvent (yield 60%).

Melting point 125°C

IR (KBr disc) 3024, 2923, 2690, 1631, 1593, 1582, 1548, 1481, 1413, 1323, 1214, 1101, 1072, 1009, 992, 974, 949, 871, 824, 736 and 704cm⁻¹.

Mass Spectral Analysis m/e 261; m/e 259 and m/e 160

C₁₃H₁₀NBr theory %C 60; %H, 3.84: found %C, 59.65; %H, 3.95.

6.3.12 Preparation Of 4-Methylbenzeneboronic acid

A Grignard reagent was prepared from 4-bromotoluene (3.6g, 0.021M) and Mg turnings (0.6g, 0.025M) in THF-borane complex (84mls, 0.083M) was slowly added to the grignard reagent. The reaction mixture was stirred at room temperature for 24 hours. A 10% aqueous HCl solution (10ml) was slowly added. The reaction mixture was extracted with diethyl ether (3 x 10mls) and dried over anhydrous sodium sulphate. The solvent was removed under reduced pressure and a white product was triturated with petroleum ether (60/80) (yield 71%).

Melting point 243°C (lit. val. 242°C) [7]

IR (KBr disc) 3275, 1612, 1570, 1520, 1410, 1370, 1270, 1190, 1095, 820, 730 and 630cm⁻¹.

NMR (DMSO) ppm; 7.9-7.6 (2H, m); 7.3-7.0 (2H, m); 2.3 (3H, s)

Mass Spectral Analysis m/e 396; m/e 395

C₇H₉BO₂ theory %C, 61.34; %H, 6.67: found %C, 61.69; %H, 6.71.

6.3.13 Preparation Of 4-Methoxyphenylboronic Acid

A grignard reagent was prepared from 4-bromoanisole (10ml, 0.035M) and magnesium turnings (1.28g, 0.05M) in dry THF (10ml) under N₂. The grignard reagent solution was added dropwise to a stirred, cooled (-78°C) solution of triisopropylborate (18.8ml, 0.124) in dry THF (10ml) under N₂. The stirred mixture was allowed to warm to RT. A 10% aqueous solution of HCl (80ml) was added with stirring. The aqueous solution was extracted with diethyl ether (2 x 50ml). The combined ethereal extracts were washed with water and dried over anhydrous MgSO₄. The solvent was removed under reduced pressure. White crystals were precipitated from petroleum ether (60/80) (80% yield).

Melting point 202°C (lit. val. 202-204°C) [8]

UV (CH₃OH) λ_{max} 273nm, ε 4000 l mol⁻¹cm⁻¹

NMR (CDCl₃) ppm; 7.86-6.84 (4H, m); 3.83 (3H, s)

Mass Spectral Analysis m/e 402, 332, 268, 242 and 152

C₇H₉O₃B theory %C, 56.07; %H, 5.97: found %C, 55.93; %H, 6.08.

6.3.14 Preparation Of 4-Formylbenzene Boronic Acid

A mixture of 4-toluene boronic acid (5g, 0.037M), dry chloroform(150ml), benzoyl peroxide (0.65g, 0.0027M) and N-bromosuccinimide (6.5g, 0.0365M) were refluxed and irradiated with a 100 watt unfrosted tungsten lamp for three hours. A solution of hexamine (7g, 0.05M) in dry chloroform (75ml) was added and refluxing continued for 1 hour. The hot chloroform solution was decanted and the residue in the flask was extracted with HCl (40ml, pH 3.5). The HCl solution was refluxed for 1 hour and the resulting solution poured quickly into a beaker and treated immediately. The crystals were collected and recrystallised from water as white crystals (yield 27%).

Melting point 240°C (lit. val. 240°C) [9]

IR (KBr disc) 3396, 2925, 2854, 1665, 1451, 1170, 1038, 887, 865, 720 and 667cm⁻¹.

NMR (CD₃COCD₃) ppm; 10.24 (1H, s); 8.22-7.84 (4H, m); 2.04 (3H, s)

Mass Spectral Analysis m/e 395 and 394

C₇H₇BO₂ theory %C, 56.07; %H, 4.71: found %C, 55.93: %H, 4.74.

6.3.15 Preparation of 1-Methyl-4-[2-(4benzene boronic acid)ethenyl]pyridinium methosulphate

To a round bottom flask containing methanol (2ml) and dimethyl sulphate (0.4g, 0.005M), 4-picoline (0.28g, 0.003M) was added dropwise making sure the temperature did not exceed

40°C. After leaving the solution to stand for one hour 4-formylbenzene boronic acid (0.5g, 0.003M) and piperidine (0.6ml) were added. The reaction mixture was refluxed for one hour. On cooling, acetone was added to the reaction mixture and a yellow precipitate was formed. The precipitate was filtered, dried and recrystallised from a water/methanol mixture (yield 70%)

Melting Point 223-225°C

IR (KBr disc) 3438, 2704, 1625, 1584, 1565, 1483, 1425, 1332, 1284, 1228, 1108, 1070, 943 and 708cm⁻¹.

UV (H₂O) λ_{max} 341nm, ε40000

C₁₅H₁₈NBSO₆ theory %C, 51.30; %H, 5.12; %N, 3.99: found %C, 51.10; %H, 5.21; %N, 4.16.

6.3.16 Preparation Of 4-cyanocinnamaldehyde

A mixture of 4-cyanobenzaldehyde (1g, 7.5mmol) and formylmethylenetriphenylphosphorane (3g, 10mmol) in anhydrous benzene (50ml) was heated under reflux for 24 hours. The solvent was removed under reduced pressure, a brown crystalline material was left in the flask. The brown material was shaken up with diethyl ether (500ml). The diethyl ether was removed under reduced pressure leaving a yellow solid which was recrystallised from water (yield 60%).

Melting point 136°C (lit. val. 135-137°C) [10]

IR (KBr disc) 2923, 2854, 2229, 1702, 1606, 1570, 1461, 1415, 1377, 1310, 1296, 1203, 1172, 1013, 1172, 1013,

829 and 737cm⁻¹.

NMR (CDCl₃) ppm; 9.94-9.63 (1H, d); 7.79-6.5 (6H, m).

Mass Spectral Analysis m/e 157 and 156

6.3.17 Preparation Of Diazomethane [11]

KOH solution (6M, 5ml) was covered with ether (30ml) and kept at around 0°C, using a slush bath. N-Methyl-N-nitrosourea (0.165g) was added in smaller portions to the cold bilayer with constant stirring. The ether layer was observed to become a bright yellow colour. The ether layer was decanted into another flask. The diazomethane was used immediately as an ethereal solution.

6.3.18 Homogeneous Modification Of Polyvinyl Alcohol With Various Aldehydes [4]

The ratio of aldehyde was calculated on a mole % basis using the following :-

$$\frac{(\text{weight SbQ/Mol. Weight SbQ})}{(\text{weight PVA/49})} \times 100$$

The value 49 corresponds to the following ratio:-

$$\frac{\text{Mol. Weight PVA/Degree Of Polymerisation}}$$

Accordingly, Xg of aldehyde was dissolved in the minimum amount of water, heat if necessary. To a PVA solution at Y°C, add the dissolved aldehyde and stir in until homogeneous. A pH of 2 was achieved by the addition of phosphoric acid (85%). The reaction mixture was neutralised to above pH5 by

the addition of ion exchange resin Amberlyst A-21. The % of aldehyde grafted onto the PVA backbone was measured by precipitating with acetone, filtering the PVA. A known weight of PVA was redissolved in H₂O and a UV spectrum obtained. The amount of aldehyde grafted is calculated using the Beer-Lambert law (table 6.1).

Table 6.1 Homogeneous Acetalisation Of Various Aldehydes To Aldehydes

ALDEHYDE	MOLE %	TEMP (°C)	TIME (HOURS)	% GRAFTED
4SbQ	0.50	60	5	>90
4SbQ	1.25	60	5	>90
4SbQ	1.50	60	5	>90
4SbQ	1.75	60	5	>90
2SbQ	0.50	60	5	>90
2SbQ	1.25	60	5	>90
2SbQ	1.50	60	5	>90
2SbQ	1.75	60	5	>90
cinnamaldehyde	0.50	60	5	42-60
cinnamaldehyde	0.50	60	7	43-56
cinnamaldehyde	0.50	60	O/N	44-64
cinnamaldehyde	0.50	40	O/N	40
cinnamaldehyde	1.00	60	5	40-60
cinnamaldehyde	1.00	60	7	45
cinnamaldehyde	1.00	60	O/N	45-55
cinnamaldehyde	1.00	40	O/N	45
cinnamaldehyde	2.00	60	5	gelled
cinnamaldehyde	2.00	RT	O/N	gelled
4-methoxycinnamaldehyde	0.50	60	2	49

ALDEHYDE	MOLE %	TEMP (°C)	TIME (HOURS)	% GRAFTED
4-methoxycinnamaldehyde	0.50	60	5	30-44
4-methoxycinnamaldehyde	0.50	60	7	30
4-methoxycinnamaldehyde	0.50	60	O/N	30
4-methoxycinnamaldehyde	1.00	60	5	35
4-methoxycinnamaldehyde	1.00	60	7	26-28
4-methoxycinnamaldehyde	1.00	60	O/N	23-25
4-methoxycinnamaldehyde	2.00	60	5	gelled
3-(2-furyl)acrolein	0.50	60	5	60-65
3-(2-furyl)acrolein	1.00	60	5	25
3-(2-furyl)acrolein	2.00	60	5	20
3-(2-furyl)acrolein	1.00	60	24	60
3-(2-furyl)acrolein	1.00	60	2	30-40
3-(2-furyl)acrolein	1.00	RT	2	53
2-furfural	1.00	60	2	70
5-ethyl furfural	1.00	60	2	80
4-cycanocinnamaldehyde	1.00	60	5	40

6.4 References

1. J.F. McKellar and P.H. Turner, *Fluorescence News*, 7, 4 (1973)
2. J.F. McKellar and N.S. Allen, "Photochemistry Of Man-made Polymers", Applied Science Publishers Ltd., UK, chapter 7 (1979)
3. C.A. Finch, "Polyvinyl Alcohol, (Ed. C.A. Finch)", John Wiley and Sons, Inc., NY, chapter 4, 1973
4. K. Ichimura and S. Watanabe, *J. Polym. Sci., Polym. Chem. Ed.*, 20, 1418 (1982)
5. J.L.R. Williams, R.E. Adel, J.M. Carlson, G.A. Reynolds, D.G. Borden and J.A. Ford, *J. Org. Chem.*, 28, 387 (1963)
6. K. Alwair and J Grimshaw, *J. Chem. Soc., Perkin Trans.*, 2 (8), 1150 (1973)
7. G.W. Kabalka, U. Sastry and K.A.R. Sastry, *J. Organometallic Chem.*, 259, 269 (1983)
8. F.R. Bean and J.R. Johnson, *J. Amer. Chem. Soc.*, 54, 4415 (1932)
9. H.R. Snyder, A.J Reedy and W.J. Lennarz, *J. Amer. Chem. Soc.*, 80, 835 (1958)
10. G. Malone and A. Vecchi, US Patent, 2,993,834 (1957)
11. *Aldrichimica Acta*, 16(1), 3 (1983)