



City Research Online

City, University of London Institutional Repository

Citation: Le, B. T., Divall, S. and Taylor, R.N. (2015). The effect of a forepole umbrella system on the stability of a tunnel face in clay. Paper presented at the XVI European Conference on Soil Mechanics and Geotechnical Engineering (ECSMGE), 13-17 Sep 2015, Edinburgh, UK.

This is the accepted version of the paper.

This version of the publication may differ from the final published version.

Permanent repository link: <https://openaccess.city.ac.uk/id/eprint/12511/>

Link to published version:

Copyright: City Research Online aims to make research outputs of City, University of London available to a wider audience. Copyright and Moral Rights remain with the author(s) and/or copyright holders. URLs from City Research Online may be freely distributed and linked to.

Reuse: Copies of full items can be used for personal research or study, educational, or not-for-profit purposes without prior permission or charge. Provided that the authors, title and full bibliographic details are credited, a hyperlink and/or URL is given for the original metadata page and the content is not changed in any way.

City Research Online:

<http://openaccess.city.ac.uk/>

publications@city.ac.uk

The effect of a forepole umbrella system on the stability of a tunnel face in clay

Effet d'une voûte parapluie sur la stabilité du front de taille en terrain argileux

*B.T. Le^{*1}, S. Divall¹ and R.N. Taylor¹*

¹ *City University London, London, United Kingdom*

^{*} *Corresponding Author*

ABSTRACT: A new series of three-dimensional centrifuge model tests using soft clay has been conducted using the geotechnical centrifuge facility at City University London. These tests aim to quantify the reinforcing proficiency of different arrangements of steel pipes in a Forepoling Umbrella System (FUS). The results highlight some interesting effects of the FUS on tunnel stability and the spread of ground movements in the vicinity of the tunnel heading.

RÉSUMÉ: Nous avons effectué une série d'essais tridimensionnels sur modèles réduits en centrifugeuse dans une argile tendre, à l'aide de la centrifugeuse géotechnique de City University London. Notre but était de quantifier les capacités de renforcement de la voûte parapluie (FUS: Forepoling Umbrella System) avec divers arrangements des tubes métalliques. Les résultats des essais mettent en évidence certains effets intéressants de la FUS sur la stabilité du tunnel et sur la propagation des mouvements de terrain dans la proximité du perçage.

1 INTRODUCTION

A Forepoling Umbrella System (FUS) consists of steel pipes installed from the tunnel face in an umbrella shape around the excavation area (Figure 1). This is usually undertaken to provide additional support and reduce ground movements. In some cases, grout is injected via pre-perforated steel pipes to form a closed umbrella canopy above the tunnel heading to prevent water and soil from ingress into the tunnel.

A schematic diagram of a FUS is presented in Figure 2, where D is the tunnel diameter, C is the cover above the tunnel crown, P is the protruded length of heading between the tunnel lining and tunnel face and S is the spacing between the steel pipes.

The FUS with the length, L , is installed from within the tunnel heading at an insertion angle, β . In order to remain a sufficient support to the tunnel head-

ing, a minimum embedded/overlap length, EL , of the FUS is required ahead of the tunnel face. After the excavation of a tunnel section of length $L - EL$, the next FUS is installed. This leaves an overlap of EL between the two FUS sections.

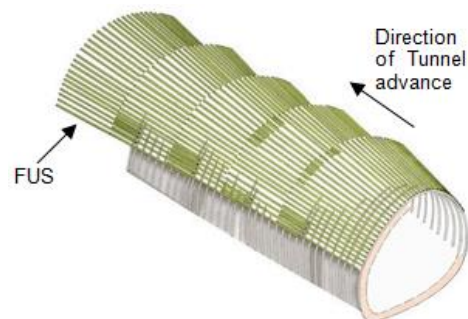

Figure 1. Forepoling Umbrella System (after Carrieri et al. 2002).

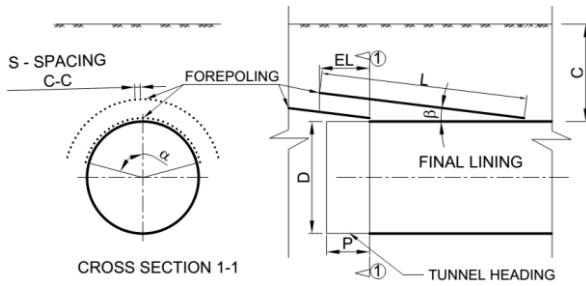

Figure 2. FUS schematic diagram.

Generally, the steel pipes used in a FUS are 70mm to 200mm diameter with a wall thickness of 4mm to 8mm. The lengths of steel pipes vary from 12m to 18m. The insertion (β) and filling angles (α) vary from 5° to 7° and 60° to 75° , respectively. The minimum EL is usually between 3m and 6m. The spacing (S) is from 300mm to 600mm (centre to centre).

Precise values for the above variables are selected as a function of tunnel geometry and ground conditions for maintaining sufficient support. Despite the increase in the use of FUS in urban tunnelling, guidance and information on the effects of the above variables are limited.

2 BACKGROUND

It is advantageous to understand the overall patterns of pre-collapse movements in order to appreciate how these variables may effect any tunnelling-induced ground movements. These pre-collapse movements have been shown to be reasonably consistent with overall failure mechanisms and therefore highly dependent on the tunnel face stability (Mair & Taylor 1997).

Broms & Bennermark (1967) investigated the stability of a tunnel face and defined the stability ratio, N , as the difference between overburden stress at the tunnel axis and the tunnel support pressure expressed as a ratio of the undrained shear strength S_u as:

$$N = [\gamma(C + D/2) - \sigma_T] / S_u \quad (1)$$

where: γ : unit weight of soil,
 σ_T : tunnel support pressure.

Soil movement prediction due to tunnelling is essential when designing a FUS distribution. For stability away from the tunnel face, Davis et al. (1980) proposed four upper bound collapse mechanisms for the transverse plane strain section of a circular tunnel. Mechanisms A and B are “roof” and “roof and sides”. Mechanism C is the mechanism which combined mechanisms A and B. Mechanism D is known as “roof, sides and bottom”. The latter two mechanisms are shown in Figure 3.

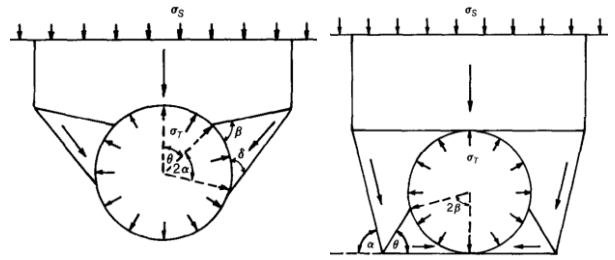

(a) Upper bound mechanism C (b) Upper bound mechanism D

Figure 3. Upper bound mechanisms (Davis et al. 1980).

Figure 4 presents the upper bound mechanism for a plane strain heading (also by Davis et al. 1980).

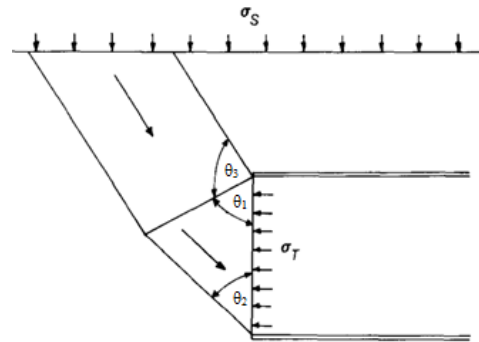

Figure 4. Upper bound mechanisms for a plane strain heading (after Davis et al. 1980).

Previous studies into the effects of soil reinforcement at a tunnel heading have been undertaken by Calvello & Taylor (1999), Juneja et al. (2010) and Yeo (2011) using centrifuge modelling techniques. Calvello & Taylor (1999) found that long spiles (beyond the zone of significant movement ahead of the tunnel face) concentrated near the tunnel periphery

delivered significant reduction in ground movement. Juneja et al. (2010) reported that the use of forepoles reduced the length of the settlement trough ahead of the tunnel face. Yeo (2011) observed a significant improvement to the tunnel heading stability made by very long forepoles.

3 CENTRIFUGE MODELLING TESTS

3.1 Methodology

In situ stresses within the soil mass are a key factor in determining ground deformation behaviour. Thus, physical modelling studies generally require the reproduction of a representative self-weight stress regime (Mair 1979).

Taylor (1995) states that centrifuge modelling techniques, by means of inertial radial acceleration, can create a proper self-weight effect in a small scale model identical to a full scale prototype. Hence, the soil behaviour at a prototype scale can be replicated in a model of 1/n scale. With careful selection of dimensions and materials the structural behaviour of steel pipes can also be modelled. Therefore, centrifuge model tests can deliver valuable insights into the effect of a FUS on tunnel face stability in clay.

3.2 Centrifuge model testing setup

A series of three-dimensional tunnel heading tests in kaolin clay were undertaken. The Speswhite kaolin slurry was one-dimensionally consolidated to a vertical effective stress, σ'_{v0} , of 175kPa. The water table was set 20mm below the ground surface and the tests were conducted at 125g. The key variables of the four tests are summarised in Table 1.

Only half of the prototype was modelled with a plane of symmetry through the tunnel centre-line (as shown in Figure 5). The total length of the tunnel is 190mm. The stiff tunnel lining was 165mm long and modelled by a 50mm diameter semi-circular brass tube. The 25mm long unlined portion of the tunnel, P, was supported by compressed air within a rubber bag. Fourteen 1mm diameter brass rods were inserted in to model via a guiding device (Figure 6). Brass was chosen since, according to scaling laws, the 1mm diameter rods in a 1:125 model have an equivalent bending stiffness to steel pipes of 114mm diame-

ter with 8mm wall thickness at prototype scale. The insertion angle was set to 5° .

Table 1. Tests variables

| Test ID | L (mm) | EL (mm) | S (mm) | α (o) |
|---------|--------|---------|-------------------------|--------------|
| 2BL | 100 | 25 | 1.7 – 3.4 (see text) | 75 |
| 3BL | 100 | 50 | 3 | 90 |
| 4BL | 100 | 25 | 3 | 90 |
| 5BL | 0 | 0 | 0 | 0 |

The tunnel support pressures when the models were accelerated to 125g were 381kPa in 2BL and 3BL and 368kPa for 4BL and 5BL. The reasons for this difference are discussed later.

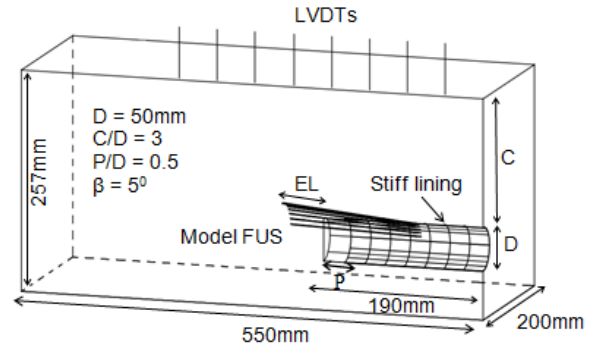

Figure 5. Diagram of model apparatus.



Figure 6. Guide produced by high-resolution 3D printer for precise installation of brass rods.

The quantity, length and diameter of brass rods used in tests 2BL, 3BL and 4BL were identical. In test 2BL the distribution of the brass rods were focused around the tunnel crown (i.e. the spacing between the eight upper rods was 1.7mm but the six lower rods had a spacing of 3.4mm). In tests 3BL and 4BL all the rods were evenly spaced at 3mm. In the reference test (5BL) there was no reinforcement. Schematics of the FUS arrangements are presented in Figure 7.

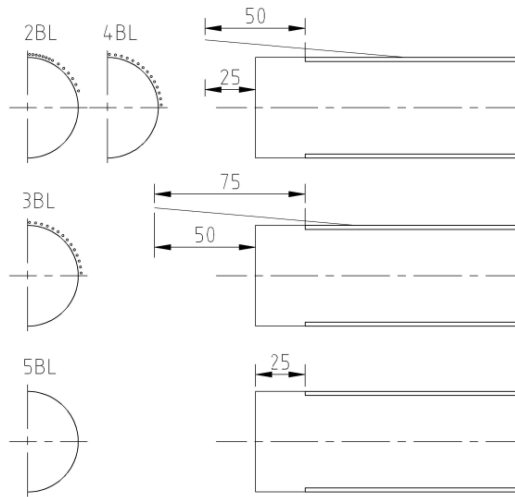

Figure 7. FUS arrangement in 4 tests (unit: mm).

3.3 Testing procedure

The models were accelerated to 125g and left running until pore pressures were hydrostatic relative to the base aquifer and the clay had reached effective stress equilibrium. During the spin-up phase the tunnel pressure was increased to balance the overburden pressure.

The test consisted of gradually reducing the tunnel support pressure to zero over a period of about 3 minutes. This technique has been shown to be successful in simulating tunnelling-induced ground movements (e.g. Mair 1979). Figure 8 shows an example of images captured during the testing phase.

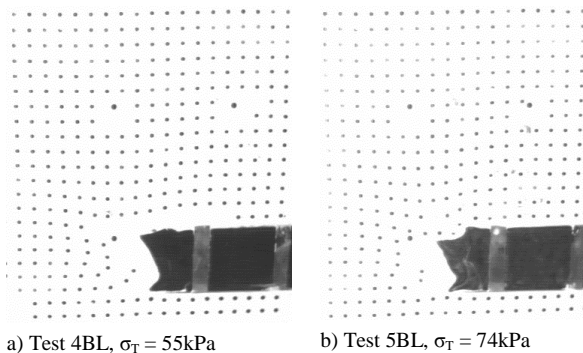

Figure 8. In-flight images of tests 4BL and 5BL

Data from the settlement transducers (Linear Variable Differential Transformers, LVDTs), Pore-

pressure Transducers and Tunnel Pressure Transducer during tests were recorded for later analysis.

4 RESULTS

The aim of the test series was to investigate the reinforcement efficiency of different forepole arrangements. The efficiency was quantified using the vertical surface settlement directly above the tunnel face and the tunnel stability (Calvello & Taylor 1999). Figure 9 shows the vertical surface settlement directly above the tunnel face in each of the 4 tests as the tunnel support pressure was reduced.

Mair (1979) defined the point of collapse by tunnel support pressure at which ground deformation started to increase rapidly. Using this definition, the tunnel support pressures at failure, σ_{TC} , in the 4 tests were found to be: 105kPa (2BL), 95kPa (3BL), 102kPa (4BL) and 119kPa (5BL).

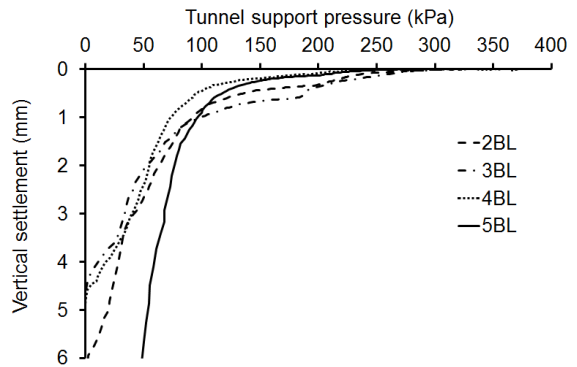

Figure 9. Vertical surface settlement above tunnel face in 4 tests.

Figure 10 shows the overall pattern of subsurface settlements in the vertical plane through the longitudinal axis of the tunnel. The crosses represent the initial positions of the targets and the vectors show targets' displacements.

4.1 Changes in testing apparatus and their effects

Figure 9 shows that the settlement developed as σ_T was reduced from the initial pressure to around 220kPa was generally small for all tests. However, an additional settlement developed in tests 2BL and 3BL as σ_T was reduced further from about 220kPa to 180kPa. This was attributed to a lack of hoop stiff-

ness of the model tunnel lining and was confirmed by the ground movements above the lining which can be seen in Figure 10. Stiffeners were added to the lining for subsequent tests and this reduced the settlement immediately above the lining as well as at the ground surface prior to tunnel collapse. In reevaluating the test procedures, it was decided to use 368kPa as the tunnel support pressure during the equilibrium phase for tests 4BL and 5BL.

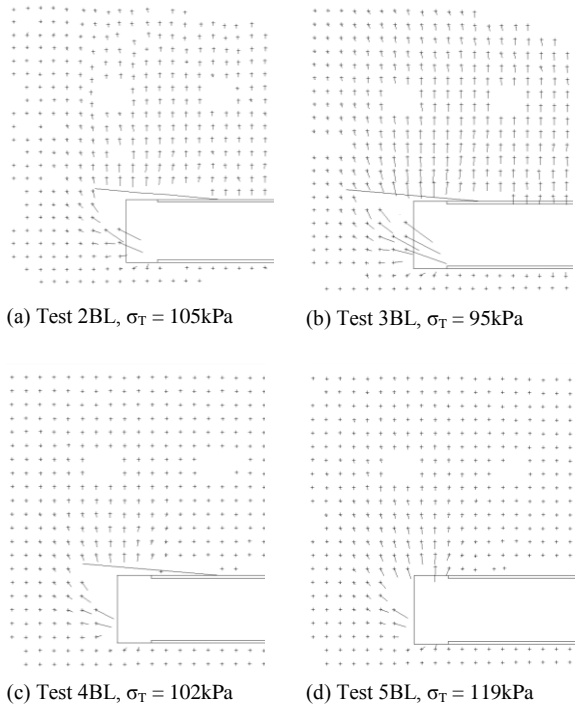

Figure 10. Ground displacement vectors, magnified by 4.

4.2 Tunnel stability ratios

For clay with over-consolidation ratio values of between 1 and 1.5, Mair (1979) used the following equation to estimate the undrained shear strength of the clay in tunnel stability ratio calculations:

$$S_u = 0.18\sigma'_{vo} \quad (2)$$

Table 2 presents the stability ratios at collapse, N_{TC} , calculated by using Equation 1 and S_u from the Equation 2.

Table 2. Stability ratio at collapse

| Test | S_u (kPa) | σ_{TC} (kPa) | N_{TC} |
|------|-------------|---------------------|----------|
| 2BL | 32 | 105 | 8.6 |
| 3BL | 32 | 95 | 8.9 |
| 4BL | 32 | 102 | 8.7 |
| 5BL | 32 | 119 | 8.2 |

4.3 Effect of FUS presence

Inflight images captured from the camera during the tunnel pressure reduction period (Figure 8) suggested that the tunnel heading in the unreinforced test (5BL) comprised crown and face collapse whereas in reinforced tests, face collapse was dominant. This difference denotes that the FUS above a tunnel heading reduced the soil mobilisation from tunnel crown.

From Figure 9 it is evident that the FUS presence reduced the magnitude of the tunnelling-induced surface settlements. Moreover, the stability increase is reflected in the lower tunnel support pressures and higher stability ratio at failure.

The development of surface settlement was also affected by the FUS. The increases of settlement with tunnel support pressure reduction for tests 2BL, 3BL and 4BL were less pronounced than that for the unreinforced test (5BL). The effect of the structural reinforcements is reflected in the different inflexion points between each test. This phenomenon was not present in the unreinforced test.

4.4 FUS working mechanism

Figure 11 shows the typical deformed shapes of the brass rods post-test for 2BL, 3BL and 4BL.

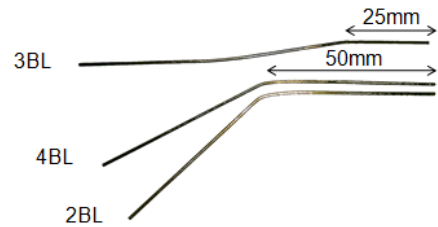

Figure 11. Brass rods post-test in reinforced tests.

The rods in tests 2BL and 4BL had one point of bending which coincided with the edge of the tunnel lining. However, the rods in test 3BL had two points of bending which may indicate the development of a different collapse mechanism in this test. For example, the longer EL may have provided greater re-

straint in the brass rods which resulted in smaller deformations and better reinforcing efficiency.

The brass rods inspected post-test from the tunnel crown and near the spring-line of the tunnel showed considerable deformations. The subsurface ground deformations (Figure 10) show movement from the tunnel invert into the tunnel heading. This indicates the tunnel mechanism involves soil movement from the “top”, “sides” and “bottom”.

4.5 Effect of FUS in different arrangements

In order to investigate the effect of the FUS in different arrangements independently from the changes made to the brass lining (see section 4.1), Figure 12 shows the change of vertical surface settlement for tests 2BL, 3BL and 4BL as the tunnel support pressure was reduced from 180kPa to 0kPa.

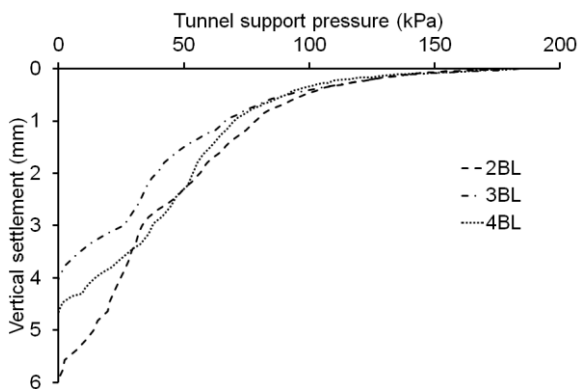

Figure 12. Vertical surface settlement above tunnel face in 3 reinforced tests

Test 3BL with the longer EL in front of tunnel face generated smaller final surface settlement and had a higher tunnel stability compared to 2BL and 4BL. The settlements in tests 2BL and 4BL were very similar until σ_T was reduced below 30kPa. This may have been a result of the greater concentration of brass rods near the tunnel spring line ($\alpha = 90^\circ$) used in Test 4BL which apparently delivered a better reinforcing effect.

5 SUMMARY

The results obtained from the centrifuge model tests have begun to show the beneficial effects of using

soil reinforcing (FUS) for reducing tunnelling-induced ground movements.

A series of four centrifuge tests using the same quantity of FUS but with varied geometric arrangements delivered interesting results. Essentially, the longer EL was shown to provide better reinforcing efficiency. Also, having sufficient forepoles to reduce lateral movements near the tunnel spring-line was seen to be important in increasing stability and reducing overall settlements.

Further tests are planned which will provide a more extensive comparison with existing upper bound collapse mechanisms such as those proposed by Davis et al. (1980). This will allow an optimal FUS arrangement to be determined.

ACKNOWLEDGEMENT

The authors are grateful to the colleagues in the Research Centre for Multi-scale Geotechnical Engineering at City University London for their support.

REFERENCES

- Broms, B.B. & Bennermark, H. 1967. Stability of clay in vertical openings. *J. Soil Mechanics and Foundation Division*. American Society of Civil Engineers **93**, SM1, 71-94.
- Carrieri, G., Fiorotto, R., Grasso, P. & Pelizza, S. 2002. Twenty years of experience in the use of the umbrella-arch method of support for tunnelling. *Proc. 4th Int. Workshop on Micropiles*, Venice.
- Calvello, M. & Taylor, R.N. 1999. Centrifuge modelling of a spile-reinforced tunnel heading. *Proc. 2nd Int. Symp. Geotechnical Aspects of Underground Construction in Soft Ground*. Tokyo.
- Davis, E.H., Gunn, M.J., Mair, R.J. & Seneviratne, H.N. 1980. The stability of shallow tunnels and underground openings in cohesive material. *Géotechnique* **30**, No. 4, 397-416.
- Juneja, A., Hedge, A., Lee, F.H. & Yeo, C.H. 2010. Centrifuge modelling of tunnel face reinforcement using forepoling. *Tunnelling and Underground Space Technology* **25**, 377-381.
- Mair, R.J. 1979. *Centrifugal modelling of tunnelling construction in soft clay*. PhD Thesis, University of Cambridge
- Mair, R.J. & Taylor, R.N. 1997. Theme lecture: Bored tunnelling in the urban environment. *Proc. 14th Int. Conf. Soil Mechanics and Foundation Engineering*, Hamburg. Balkema, Rotterdam.
- Taylor, R.N. 1995. *Geotechnical Centrifuge Technology*. Blackie Academic and Professional, Glasgow.
- Yeo, C.H. 2011. *Stability and collapse mechanisms of unreinforced and forepole-reinforced tunnel headings*. PhD Thesis, National University of Singapore.