



City Research Online

City, University of London Institutional Repository

Citation: Haidar, A., Fothergill, J., Dissado, L. A. & Hopewell, P. (2003). Anomalous dielectric response of very small quantities of virgin, aged and failed silicone oil. *IEEE Transactions on Dielectrics and Electrical Insulation*, 10(2), pp. 336-342. doi: 10.1109/tdei.2003.1194120

This is the unspecified version of the paper.

This version of the publication may differ from the final published version.

Permanent repository link: <https://openaccess.city.ac.uk/id/eprint/1374/>

Link to published version: <https://doi.org/10.1109/tdei.2003.1194120>

Copyright: City Research Online aims to make research outputs of City, University of London available to a wider audience. Copyright and Moral Rights remain with the author(s) and/or copyright holders. URLs from City Research Online may be freely distributed and linked to.

Reuse: Copies of full items can be used for personal research or study, educational, or not-for-profit purposes without prior permission or charge. Provided that the authors, title and full bibliographic details are credited, a hyperlink and/or URL is given for the original metadata page and the content is not changed in any way.

City Research Online:

<http://openaccess.city.ac.uk/>

publications@city.ac.uk

Anomalous dielectric response of very small quantities of virgin, aged and failed silicone oil

A. Haidar¹, J.C. Fothergill², L.A. Dissado², P. Hopewell³

1: Physics Department, Faculty of Sciences (I), The Lebanese University

2: Department of Engineering, University of Leicester, UK, (JCF@LE.AC.UK)

3: Power Technologies International Ltd, UK

Abstract

A technique is described for making dielectric spectroscopy measurements of very small quantities ($< 1 \mu\text{l}$) of oil. The technique utilises surface tension to hold the oil between the plates of a capacitor, the inter-electrode distance being controlled by a micrometer.

Breakdown strength can also be estimated using this technique. Three samples of silicone oil, used in cable sealing ends, were tested: virgin, used and failed. A major component in the frequency dependent impedance had the form $Z(\omega) = B(1 - b(i\omega)^{1-p})$. This component was interpreted in terms of a fractal percolation model, and the anomalous thickness dependence predicted by the model verified by varying the inter-electrode distance. The difference observed for the three different samples indicate that conducting contaminants are responsible for the percolation system.

Index terms: silicone oil, electrical breakdown, thickness dependence, dielectric spectroscopy, percolation, fractal circuit, cable sealing end, contaminant

Introduction

Silicone oil is typically used for controlling the electric field in high voltage insulating systems such as transformers and cable joints. Three samples of silicone oil were investigated. The samples were of the same silicone oil but differed in their histories:

Virgin oil: A new, unused sample of oil

Used oil: A sample of oil taken from one of three 132 kV XLPE cable sealing ends comprising part of a 3-phase system at the location where the power was transferred from XLPE cables to an overhead network. The sealing end had been in use for approximately 9 years and was working satisfactorily.

Failed oil: A sample from another of the three cable sealing ends, which had failed, following internal discharge activity, and exploded.

Amongst other tests, it was decided to measure the oil using dielectric spectroscopy (mainly to establish whether its dielectric loss had increased substantially during ageing at power frequencies) and to estimate its dielectric breakdown strength. It is known that the latter decreases rapidly in the presence of discharges [1] and that the oil may depolymerise and contain metallic impurities from the discharging electrodes [1, 2]. Dielectric spectroscopy, in which the complex impedance is measured over a wide range of frequencies, is known to be highly sensitive to small changes in electrical properties. It was thought that dielectric spectroscopy would provide a means of distinguishing the extent of these changes. Using

dielectric spectroscopy it would be possible to establish whether the oil had dissipated too much power, causing overheating and premature failing of the cable sealing end.

Experimental Technique

A particular problem that had to be overcome in characterising these oils was that only very small quantities were available. Less than 0.5 μl of the failed oil was available. A technique was therefore devised to make measurements with a “General Radio” type 1690 cell. The cell contains two metal disk electrodes of diameter 50.8 mm (2"). The gap between the electrodes could be adjusted using a micrometer calibrated in 0.5 mil graduations (1 mil = 1/1000th inch = 25.4 μm). It was found that, by repeatedly opening the gap and then re-closing it to the same graduation, the gap could be reproduced to within 2 μm as judged by the capacitance. A visual inspection indicated that the electrodes were optically flat and parallel to better than 1 μm . This was established by closing the electrodes to approximately 1 μm and checking that a clear gap could be seen between the electrodes at all points. A hypodermic syringe was used to place a small volume of oil on the fixed electrode. The micrometer was then adjusted to reduce the distance between the plates until the oil completely filled the gap. For the small gaps used in this work, the oil was held in place by surface tension. It was important to ensure that any surplus oil did not contaminate the quartz glass insulator supporting the fixed electrode. It is straightforward to check that the oil completely fills the inter-electrode spacing using the following technique.

The measured capacitance, C , is the total of the oil-filled cell capacitance and any stray capacitance, C_S :

$$C = C_S + \varepsilon_0 \varepsilon_r A \left(\frac{1}{L} \right)$$

Equation 1

where ε_0 is the permittivity of free space (8.854×10^{-12} F.m⁻¹),

ε_r is the relative permittivity of the oil,

A is the area of the electrodes and the oil sample (2.027×10^{-3} m²), and

L is the inter-electrode gap

Since we were in the fortunate position of being able to vary the thickness of the dielectric, the capacitance, C , could be measured as a function of thickness, L . By plotting C as a function of $(1/L)$, it was possible to find both C_S and ε_r , as shown schematically in Figure 1.

A straight line plot indicates that the oil completely fills the gap – i.e. that the area, A , that the dielectric occupied was invariant. It is straightforward to adjust the gap in unit of 0.5 mil from 3 mil upwards. Typically, gaps in the range 3 to 10 mil (76.2 to 254 μ m) were used; this gave sufficient points on a graph to check for a straight line. The volume of oil required for a 5 mil (127 μ m) gap is 0.26 μ l and the technique is therefore useful for small samples.

Accurate measurements of dielectric breakdown strength are not very practical with this cell since field enhancement occurs at the edges. To some extent, this is ameliorated since surface tension allows the oil to “bulge” out between the edges of the electrodes. However the cell itself is rated to >1 kV and it is therefore possible to apply a ramp voltage until oil breakdown occurs. This, at least, allows the samples to be placed in rank order of breakdown strength. Only one measurement per sample is possible since the discharge at breakdown is likely to

change the properties of the oil. In order to give an indication of breakdown strength, a DC power supply was connected across the electrodes and the voltage increased by hand at a ramp rate of approximately 10 V.s^{-1} .

Dielectric spectrometer measurements were made using a Solartron 1255 Frequency Response Analyser with CDI interface to measure real and complex capacitance. The cell was maintained at $20 \pm 0.1^\circ\text{C}$ during dielectric spectroscopy and the probe voltage was 1.00 V RMS. The variable dielectric thickness may provide an added dimension to the dielectric spectroscopy results. For example, it may be possible to separate bulk and interfacial effects.

Results

(a) Virgin Silicone Oil

Measurements were first made of real capacitance, C' , at 50 Hz at different (reducing) values of gap, L , ranging from 10 mil (254 μm) to 3 mil (76.2 μm). These are plotted in Figure 2. A good straight line is found ($r^2 = 0.998$), indicating that the oil completely filled the gap over the complete range of gaps. The slope of this line is $5.128 \times 10^{-14} \text{ F.m}$ corresponding to a relative permittivity of 2.86. The intercept is 2.77 pF corresponding to the stray capacitance. For the smallest gap of 76.2 μm , the measured capacitance was 676 pF; the stray capacitance corresponds to an error of 0.4% and was therefore insignificant.

A wide band dielectric spectrum (10^{-4} to 10^6 Hz) was therefore made at this nominal 3 mil gap; this is shown in Figure 3. The 50 Hz real capacitance of 749 pF suggests that the gap was

actually closer to 2.71 mil (68.7 μm), and so this value is used in the following calculations.

Small errors, possibly associated with parasitic shunt conductance on the cell walls, are noted at the very lowest frequencies where the capacitance appears to decrease with decreasing frequencies, a physically unrealistic effect. Noise is evident in the C'' results between 40 Hz and 100 kHz where the loss is less than the system resolution ($\tan\delta \ll 10^{-3}$). Below 1 Hz, the imaginary capacitance characteristic tends to a straight line on the $\log C'' - \log$ frequency plot with a slope of -0.84 . This straight line characteristic is maintained down to 1 mHz. Below 1 mHz the slope changes and is very close to -1 . (The 9 points from 10^{-3} Hz to 10^{-4} Hz form a straight line, $r^2 = 0.9995$, with a slope of -1.03 .) This suggests that at the lowest frequencies, a true DC conduction process is being probed. Using $G = \omega C''$, where G is the conductance, the conductivity can be estimated as $3.06 \times 10^{-13} \text{ S.m}^{-1}$ at 10^{-3} Hz.

A breakdown test was carried out whilst the oil was at this minimum thickness of 68.7 μm . During the test, no discharges were noted and the current remained at <0.2 mA until the oil suddenly broke down at a voltage >650 V. This indicated that the breakdown strength of the oil was at least $650 \text{ V}/68.7 \mu\text{m} = 9.5 \text{ kV/mm}$.

(b) Used Oil

Similar measurements were made on the oil that had been in service and had not failed. It was noted, by eye, that the oil was optically clear (it was indistinguishable from the failed oil in this respect). The viscosity appeared to be lower than the new oil.

Measurements were again made of real capacitance, C' , at 50 Hz at different (reducing) values of gap, d . These are plotted in Figure 4. A good straight line ($r^2 = 0.999$) again indicates that the oil completely filled the gap. The slope of this line is 5.00×10^{-14} F.m and is very similar to the new oil corresponding to a relative permittivity of 2.79. The intercept is 11.3 pF corresponding to the stray capacitance. This is likely to be, within experimental error, the same as the virgin oil. It would contribute less than 2% of the final gap capacitance.

The results of dielectric spectroscopy at this nominal 3 mil gap are shown in Figure 5. (The points labelled "QDC" are not data points; they are referred to in the discussion section.) The measured 50 Hz real capacitance of 767 pF suggests that the gap was actually closer to 2.61 mil (66.2 μm), and so this value is used in the following calculations. Again, noise is observed in the C'' characteristic between 10 Hz and 100 kHz, where the loss tangent is very low. Below 10 Hz the C'' characteristic follows a good straight line ($r^2 = 0.9996$) down to $f < 10^{-4}$ Hz with a slope of -0.96 , i.e. a slope very close to -1 . The effective conductivity at 10^{-3} Hz is 4.38×10^{-13} S.m $^{-1}$, which is 43% higher than that of the virgin oil.

A breakdown test was carried out whilst the oil was at this minimum thickness of 66.2 μm . Again, no discharges were noted and the current remained at < 0.2 mA until the oil suddenly broke down at a voltage $> 450 \pm 25$ V. This indicated that the breakdown strength of the oil was at least $450 \text{ V} / 66.2 \mu\text{m} = 6.8 \text{ kV/mm}$.

(c) Failed Oil

The oil that had failed was rather black – it appeared to contain a dense "mist" of very fine particles. The viscosity appeared to be the same as the used oil.

Measurements of real capacitance, C' , at 50 Hz at different (reducing) values of gap, L , are plotted in Figure 6. The measurements made at gaps greater than approximately 5 mil, i.e. $(1/L) < 8 \text{ mm}^{-1}$, did not fall on a good straight line. This indicated that the small sample of oil did not completely fill the electrode area. For smaller gaps, a reasonably good straight line ($r^2 = 0.994$) was obtained with a slope of $5.51 \times 10^{-14} \text{ F.m}$. This corresponds to a relative permittivity of 3.07 (a significant increase above the value of 2.8 found for the used and virgin oils). Stray capacitance has been ignored in this case, since it would be difficult to estimate and was found to be small in the previous cases.

The results of dielectric spectroscopy at a nominal 3 mil gap are shown in Figure 7. (Again, the points labelled "QDC" are not data points and are referred to in the discussion section.) The measured 50 Hz real capacitance of 773 pF suggests that the gap was actually closer to 2.81 mil (71.3 μm), and so this value is used in the following calculations. Below 10 Hz the C'' characteristic follows an excellent straight line ($r^2 = 0.9999$) down to $f < 10^{-4}$ Hz with a slope of -0.94 , (very close to -1). For the sake of comparison with the other oils, the effective conductivity at 10^{-3} Hz is $2.09 \times 10^{-12} \text{ S.m}^{-1}$, which is almost 5 times higher than that of the used oil and almost 7 times that of the virgin oil.

A breakdown test was carried out whilst the oil was at this minimum thickness of 71.3 μm . In this case, there was a considerable current (>1 mA) even when the voltage was as low as 80 V. As the voltage was increased, the current fluctuated considerably to >20 mA and the power supply cut out at approximately 300 V. The breakdown voltage was therefore between 80 V and 300 V corresponding to a breakdown field of 1.1 and 4.2 kV/mm.

Discussion

Dielectric Spectroscopy

The dielectric spectroscopy reported in the previous section shows some significant differences between virgin oil, used oil, and failed oil. To summarise: used oil exhibits an increase in the AC conductivity at 10^{-3} Hz but no change in relative permittivity, whereas oil that has failed showed a further increase in the AC conductivity at 10^{-3} Hz and an increase in the relative permittivity. The interpretation of these changes is not, however, straightforward as only in the case of the virgin oil can a DC conductivity be identified and, even there, only below 10^{-3} Hz. In all other cases $C'' = G/\omega$ showed anomalous frequency dependence, i.e.

$C'' \propto \omega^{-p}$ where $\omega = 2\pi f$. Such behaviour is often assigned to an electrode – sample interface effect. In this case, C'' would then be independent of the sample thickness. This is clearly not the case for the failed oil, Figure 8, in which C'' shows a thickness dependence of:

$$C'' \propto L^{-q}$$

Equation 2

with $q \cong 0.66$ and not equal to 1 as required for a bulk effect. The real capacitance C' has been shown in figures 3, 5 & 7 to be proportional to L^{-1} and hence is demonstrably a bulk effect. The dielectric response observed must therefore be taken to be the consequence of a bulk mechanism with a component, observed in C'' , that exhibits 'anomalous' behaviour.

Two types of 'anomalous' response have been identified in the literature (see for example [3,4] and references therein) that give a response of the form $C'' \propto \omega^{-p}$. These are, a constant phase angle response (CPA), with:

$$Z(\omega) = [\mathbf{i}\omega C(\omega)]^{-1} \propto (\mathbf{i}\omega)^{-p} \Big|_{\omega \rightarrow 0}$$

Equation 3

and a Fractional Power Law Response (FPR):

$$Z(\omega) = B \left[1 - b(\mathbf{i}\omega)^{1-p} \right] \Big|_{\omega \rightarrow 0}$$

Equation 4

with B and b as constants.

The CPA response implies that $C'(\omega) \propto C''(\omega) \propto \omega^{-p}$. The divergence in C' expected from the CPA behaviour is plotted and denoted as QDC (i.e. quasi-dc conductance [5]) in Figure 5 and Figure 7. The results show that a CPA response is not the likely explanation. Instead, the observed response looks like that resulting from the FPR behaviour with an additional parallel

capacitance. In [3] it was shown that the two classes of response were general forms of behaviour resulting from systems that could be described by a scaled hierarchy of R-C circuits. A specific circuit construction of this type representing a percolation system generalised from [6], was studied in [4], and this seems the most appropriate for the oil samples investigated here. FPR behaviour occurs when the system is above the percolation limit, i.e. a conducting path is established across the system. The circuit for the percolation system is constructed in the following way. A basic arrangement of impedances and capacitances is chosen that reflects the electrical form of the smallest element of the percolation system. This is called the “generator circuit”. In its most general form this circuit is composed of a row of hN impedances (Z_{n-1}) in parallel, all of which are in series with a row of $(f-h)N$ of the same impedances and $(1-f)N$ capacitances (C_0) themselves in parallel. The total number of components is N . This is shown schematically in the inset in Figure 9. In the smallest element of the percolation system, the impedances are local resistances (R_0). The $n=1$ circuit of Figure 9 shows an example of the circuit of the smallest percolation element for the case where $N=4$. The $n=2$ circuit shows a larger part of the percolation system. The basic arrangement is retained, but now the $n=1$ circuits replace the resistances of the $n=1$ circuit by a complex impedance. This procedure is repeated in the $n=3$ circuit, now using the $n=2$ circuits as generalised impedances. This methodology is called scaling and is repeated until a circuit is produced representing the whole percolation cluster. A visual inspection shows that this is composed of sub-circuits of the same basic arrangements embedded progressively within one another. This self-similarity expresses the fractal structure appropriate to percolation clusters.

The impedance derived for this circuit model of a percolation system has both anomalous frequency and sample size dependencies. Typical FPR behaviour is shown schematically in Figure 10 as a function of frequency. At very low frequencies, below $\omega = \omega_x$, a DC conductance is found with,

$$Z(\omega) = R_0 \left(\frac{L}{L_0} \right)^\delta \left| \left(\frac{\omega}{\omega_0} \right) \rightarrow 0 \right.$$

Equation 5

At these low frequencies, C' is independent of frequency and is effectively in parallel with a frequency-independent conductance. In an intermediate frequency range, above $\omega = \omega_x$ and below a fixed point frequency ω^* the FPR form is found:

$$Z(\omega) \approx \frac{1}{\mathbf{i}\omega C_0} \left[D + K \left(\frac{\mathbf{i}L^\delta \omega}{L_0^\delta \omega_0} \right)^{-\Delta} \right] \Bigg|_{\omega < \omega^*}$$

Equation 6

Here D and K are constants of the system; K is negative (see [4] for detailed expressions). L_0 is the size of the generator, and ω_0 is the generator frequency given by $\omega_0 = 1/R_0 C_0$. The exponents δ and Δ depend upon the geometry of the generator, i.e. on N, f , and h . Specifically:

$$\delta = \frac{\ln \mu}{\ln 2}$$

$$\Delta = \frac{\ln \left[\frac{2h^2N - h^3N^2 + f(1 - hN)^2}{h^2N} \right]}{\ln \mu}$$

Equation 7

with

$$\mu = \frac{f}{Nh(f - h)}$$

Equation 8

This model predicts that a DC conductance should be observed at very low frequencies while in the intermediate frequency region, $\omega_x < \omega < \omega^*$, C' and C'' can be approximated by:

$$C'' \approx (-K) \frac{C_0}{D^2} \left(\frac{L}{L_0} \right)^{-\delta\Delta} \sin \left(\frac{\Delta\pi}{2} \right) \left(\frac{\omega}{\omega_0} \right)^{-\Delta}$$

$$C' \approx C_{oil} + \frac{C_0}{D}$$

Equation 9

Here we have added a parallel capacitance C_{oil} for the oil that does not take part in the percolation system. Since this is expected to be dominant in C' we would expect C' to exhibit the normal bulk thickness dependence $C' \propto 1/L$ as observed. On the other hand, the loss component in the measuring frequency range will be governed by that contributed by the percolation system, and will exhibit an anomalous frequency and thickness dependence.

In the case of the virgin oil, the switch from the DC conductance behaviour expected for the low frequencies (Equation 5) to the anomalous behaviour described by Equation 6 is seen in Figure 3 to occur at $\omega_x/2\pi \approx 8 \times 10^{-4}$ Hz. At higher frequencies $C''(\omega) \propto \omega^{-p}$; $C' \approx \text{constant}$. For the used and aged oils, it is clear that ω_x is lower, and indeed below the lowest frequencies of observation. We can equate p with Δ , i.e. the value of (-slope) of $\log(C'')$ versus $\log(f)$ at low frequencies (Equation 9) and $\delta\Delta$ with q , the exponent of the dependence of C'' on thickness (Equation 2). It is therefore possible to establish δ for each case, Table 1.

<Please insert Table 1 about here>

Although there are several unknowns (L_0 and $\omega_0 = 1/R_0C_0$), we can nevertheless use Equation 5 and Equation 6 to determine which variable is changing.

- If L_0 were increasing and ω_0 were constant, then the DC impedance Z (Equation 5) would decrease and hence ω_x would increase; we know this is not the case.
- If both L_0 and ω_0 were constant and only δ decreased, then as before ω_x would increase; so this cannot be correct.
- Since all the frequencies are scaled by ω_0 , this must be decreasing; i.e. R_0 or/and C_0 must be increasing.

This latter scenario is quite reasonable. At the conclusion of the last section we noted that C'' for a given (low) frequency increased as the oil was used and then failed. From Equation 9 it

is clear than an increase in C_0 would cause this. Such an increase may not noticeably increase C' since this is in parallel with the oil capacitance. It is unclear exactly what the capacitors, C_0 , in the fractal circuit of Figure 9 correspond to physically. However the decrease in viscosity of the oil suggests that it is becoming depolymerised, i.e. the cyclic oligomers and longer chain molecules which form the silicone oil are smaller. If the fractal capacitor units are considered as dielectrics of a given area and thickness, the reduction in molecular size may correspond to an effective decrease in the dielectric thickness.

It is also noticeable that, for the failed oil, the real part of the capacitance increased at very low frequencies. It is possible that frequency dependent terms neglected in the approximation for C' in Equation 9, which are assumed insignificant in comparison with the capacitance of the oil at higher frequencies, may start to become significant as C_0 increases. However it is also possible that the black impurities in the failed oil may start to collect at the bottom electrode after the long times required for these measurements. In this case, if the impurities are reasonably conductive, they would effectively reduce the thickness of the sample and increase its capacitance.

Electrical Breakdown

The electrical breakdown tests also show some significant differences between virgin oil, used oil, and failed oil although it should be noted that these were not performed in an ideal way. For example, there would have been field enhancement at the electrode edges, which has not been taken into account. Furthermore, it was possible to make only one measurement under each condition; ideally, several measurements would have been made and the

distribution of results characterised. The voltage was increased by hand at a rate that would have been slightly different from one specimen to the next and the purity and dryness of the oils were unknown. In spite of this, there does appear to be a decreasing trend in breakdown strength as the oil was used: 9.5 kV/mm for the virgin oil, 6.8 kV/mm for the used oil, and, for the failed oil: 1.1 to 4.2 kV/mm. All these values are much less than would be typical for very pure oil under ideal conditions; a value closer to 100 kV/mm would be expected for highly-pure silicone oil. It is clear therefore that the measurement conditions were not ideal. The used oil has deteriorated slightly with respect to the virgin oil, possibly due to a low concentration of conducting contaminants or water ingress. It is also possible that the oil is slightly chemically degraded, for example through de-polymerisation. The failed oil clearly contained many impurities and these may well have caused partial discharging and premature breakdown [1,8]. Sporadic increasing in current was noted even at approximately 1 kV/mm, probably indicative of discharging which became so severe that the current trip level of the supply was exceeded at 4.2 kV/mm.

Conclusions

It is possible to measure the dielectric properties of very small quantities of oil, and other viscous liquids, by trapping it between the moveable, micrometer controlled, plates of an air capacitor. Quantities less than 1 μl were measured in this study without difficulty over the range 10^{-4} to 10^6 Hz, although noise prevented sensible measurement of imaginary capacitance above 10 Hz.

Fractional power law behaviour is observed in the silicone oils studied. This implies that charges percolate through the material, which can be represented as a fractal circuit containing resistive and capacitive elements. As the oil ages these characteristics change. It seems likely, although the data is not conclusive, that the size of the fractal circuit remains unchanged but the capacitive elements increase their capacitance. It is likely that, as the silicone oil ages, the oligomers breakdown into smaller molecular units and also that impurities may be present such as metal particles detached from electrodes. Smaller molecular units, if polarisable, would certainly lead to increased permittivity since they would be more mobile. Impurities may form fractal networks spanning regions of the oil; these would be short-lived as particles float through the oil.

The use of the extra dimension of varying thickness in dielectric measurements deserves further attention. Without this dimension, it is impossible to draw conclusions about percolating networks. Such networks are likely to be commonly found. They may be mistaken for DC conduction, since the fractional power laws found may be close to unity, or mistakenly attributed to electrode – interface effects if the data is not sufficiently fulsome. It is only by varying thickness and by making measurements over a wide range of frequencies that such theories can be tested conclusively.

Acknowledgements

The authors wish to thank Powergen, Power Technology Centre, Nottingham. UK, for permission to publish this paper.

References

1. G.P. McCormick and E. Howells, "Arcing resistance of High Fire Point dielectric liquids", *IEEE Trans Power Delivery*, 12(3), July 1997, 1184-1192
2. K. Abe, M. Hamaguchi, T. Umemura, "Thermal aging of silicone oil aromatic polyamide insulation systems", *IEEE Trans Dielectrics EI*, Vol. 5(4), pp. 578-582, August 1998
3. R.M.Hill, L.A.Dissado, R.R.Nigmatullin, "Invariant behaviour classes for the response of simple fractal circuits" *J.Phys.: Condens Matter*, Vol. 3, pp. 9773-9790, 1991
4. L.A.Dissado and R.M.Hill, "Constant-phase-angle and power-law regimes in the frequency response of a general determinate fractal circuit" *Phys.Rev B*, Vol. 37(7), pp. 3434-3439, 1 March 1988
5. L.A. Dissado and R.M. Hill, "Anomalous low frequency dispersion. A near DC conductivity in disordered low dimensional materials", *J. Chem. Soc. Faraday Trans. 2*, **80**, 291-319, 1984.
6. J P Clerc, G Giraud, J M Laugier and J M Luck, "Electrical properties of percolation clusters: exact results on a deterministic fractal", *J. Phys A: Math. Gen.*, Vol. 18, No. 13, 2565-2582, 11 September 1985

A. Haidar *et al*: Anomalous dielectric response ...

7. T. J. Lewis, "The electrical properties and strength of pure liquids", Chapter 6 of "High-Voltage Technology" (Editor: L.L. Alston), Oxford University Press, 1968
8. S. Birlasekaran and M. Darveniza, "Microdischarges from particles in transformer oil" IEEE Trans Electr Insul, v EI-11, n 4, (Dec 1976), p 162-163

Technical Biographies of Authors

Ali A Haidar



Dr Haidar was born in Al-waize, Lebanon in 1959. His first degree was in Physics from the Lebanese University. He then went to Chelsea College, working with Hill and Dissado, and gained a PhD in 1984 in Solid State Physics. Following this he became assistant professor and acting Head of Physics at the King Faisal University in Saudi Arabia where he set up a curriculum for the newly established Physics Department. During this time he also did postdoctoral and visiting researcher work with Hill and Dissado, now at Kings College, London. In 1991 he became Associate Professor in the Faculty of Science at the Lebanese University.

John C Fothergill (Senior Member since 1995)



Professor Fothergill was born in Malta in 1953. He graduated from the University of Wales, Bangor, in 1975 with a Bachelor's degree in Electronics. He continued at the same institution, working with Pethig and Lewis, gaining a Master's degree in Electrical Materials and Devices in 1976 and doctorate in the Electronic Properties of Biopolymers in 1979. Following this he worked as a senior research engineer leading research in electrical power cables at STL, Harlow, UK. In 1984 he moved to the University of Leicester as a lecturer. He now has a personal chair in Engineering and is currently Dean of Science.

Len A Dissado (Senior Member since 1996)



Len Dissado graduated from University College London with a 1st Class degree in Chemistry in 1963 and was awarded a PhD in Theoretical Chemistry in 1966 and DSc in 1990. After rotating between Australia and England twice he settled in at Chelsea College in 1977 to carry out research into dielectrics. His interest in breakdown and associated topics began with a consultancy with STL began in 1981. Since then he has published many papers and one book, together with John Fothergill, in this area. In 1995 he moved to The University of Leicester, and was promoted to Professor in 1998. He has been a visiting Professor at The University Pierre and Marie Curie in Paris, Paul Sabatier University in Toulouse, and Nagoya University, and has given numerous invited lectures, the most recent of which was the E.O.Forster Memorial lecture at ICSD'7 in Eindhoven. Currently he is an Associate Editor of IEEE Transactions DEI, and co-chair of the Multifactor Aging Committee.

Paul Hopewell (Member since 2001)



Dr Hopewell was born in Staffordshire, England in 1970 and received his B.Eng(Hons) in Electrical Engineering from Staffordshire University, UK in 1992. In 1995 he was awarded a PhD from UMIST, UK for his work on the integration of small scale generation with the distribution system. His career since then has included additional research into power system performance, provision of asset management services to distribution companies, power system analysis as well as generator excitation systems and transformer condition monitoring. In 2001 he joined Power Technologies as a Consultant. He is a UK Chartered Engineer and an active Member of the IEEE, a member of the Climate Change Working Group. Additionally, he is Deputy Chair for the Executive Committee of the Professional Network, Engineering for a Sustainable Future of the UK's IEE.

Table

Table 1: The constants Δ and δ for the three types of oil

	Δ (from slope)	$\Delta.\delta$ (from thickness dependence)	δ
Virgin oil	0.84	≈ 1	1.2
Used oil	0.96	≈ 1	1.04
Failed oil	0.94	0.66	0.7

Figures

Figure 1: Schematic graph showing theoretical relation between measured capacitance and reciprocal inter-electrode gap with sufficient oil filling

Figure 2: Real capacitance versus reciprocal inter-electrode gap for virgin silicone oil

Figure 3: Wide band dielectric spectroscopy measurements on virgin oil at nominal 3 mil gap

Figure 4: Real capacitance versus reciprocal inter-electrode gap for used silicone oil

Figure 5: Wide band dielectric spectroscopy measurements on used oil at nominal 3 mil gap

Figure 6: Real capacitance versus reciprocal inter-electrode gap for failed silicone

Figure 7: Wide band dielectric spectroscopy measurements on failed oil at nominal 3 mil gap

Figure 8: Imaginary capacitance (0.1 Hz) versus inter-electrode gap on bi-logarithmic axes for the failed oil. There are limited data points in which the oil completely filled the gap.

Figure 9: The construction of a self-similar fractal circuit for a percolation system. The inset shows the general circuit arrangement composed of generalised impedances Z_{n-1} and capacitance C_θ . The main diagram is a schematic of the scaling for a circuit arrangement composed of $N=4$ components at the smallest size $n=1$ level. Successive embeddings, $n=2$, $n=3$ etc. construct the circuit for the percolation system. After [4]

Figure 10: Schematic diagram showing typical FPR behaviour (after [4] in which various computed AC responses are given)

Figure 1: Schematic graph showing theoretical relation between measured capacitance and reciprocal inter-electrode gap with sufficient oil filling.

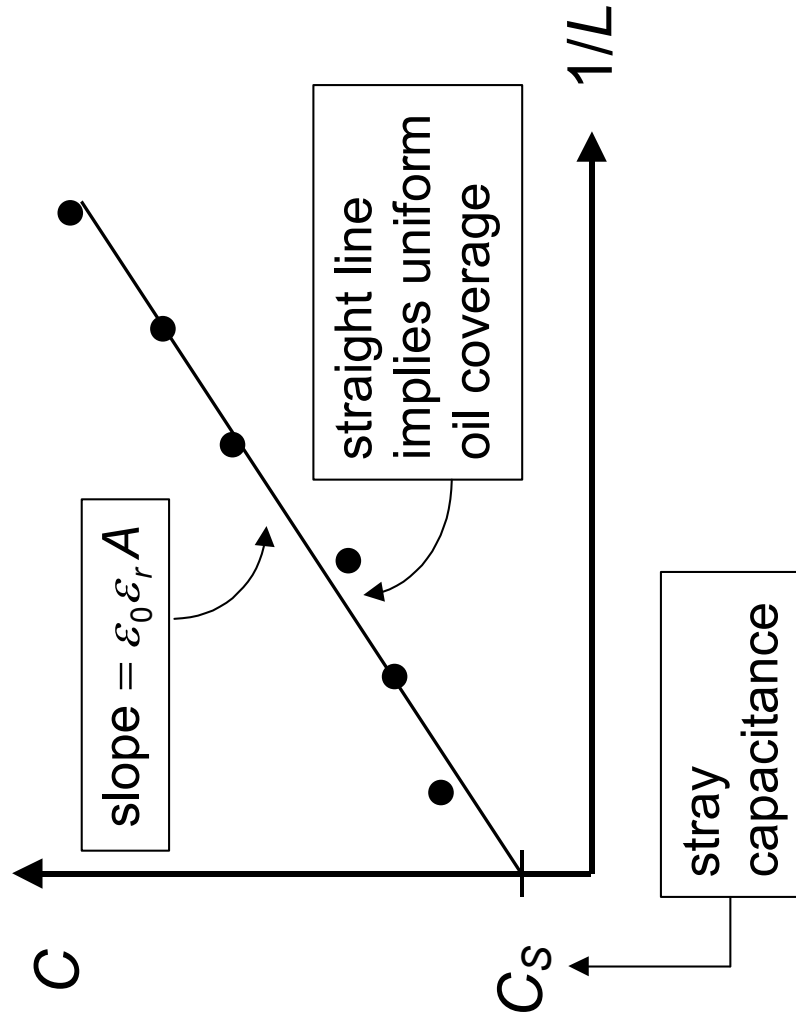

Figure 2: Real capacitance versus reciprocal inter-electrode gap for virgin silicone oil

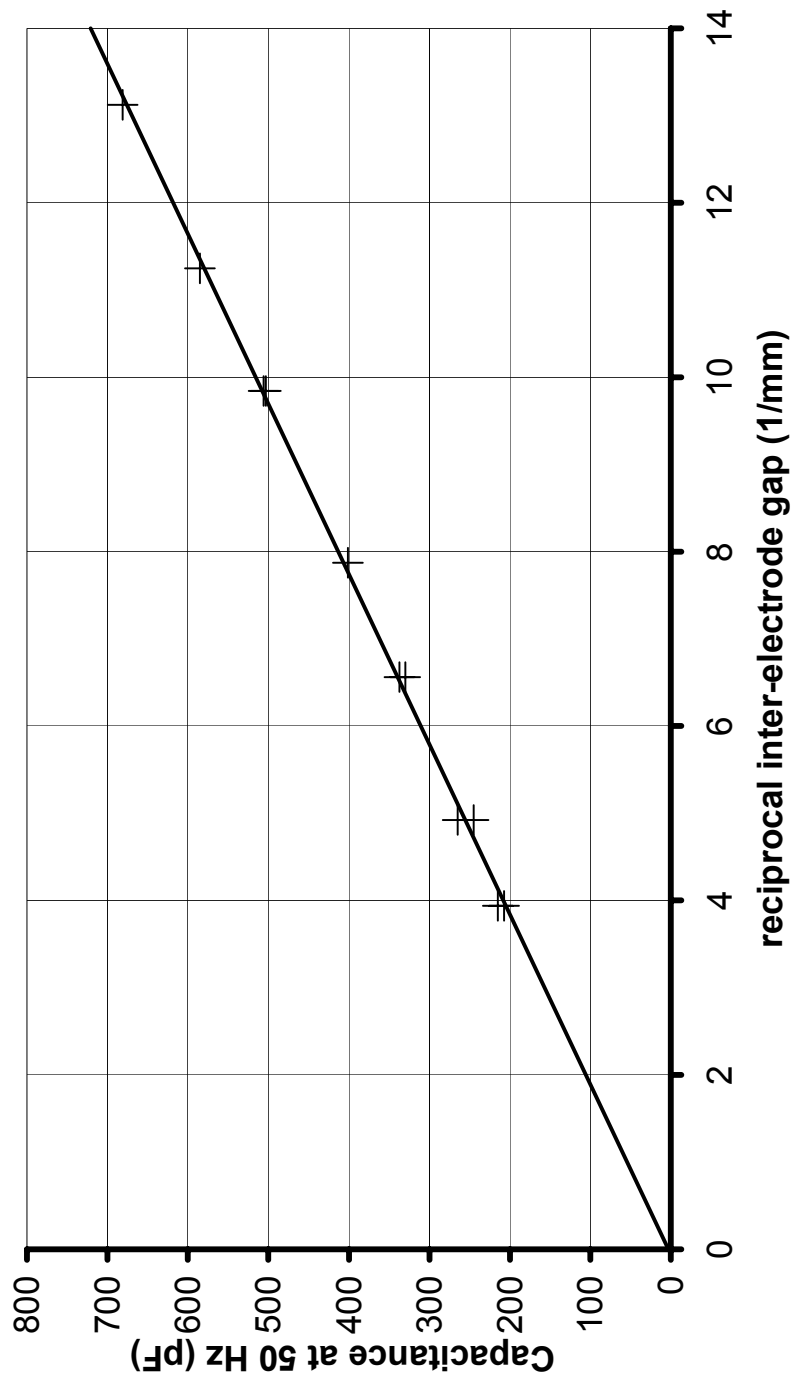

Figure 3: Wide band dielectric spectroscopy measurements on virgin oil at nominal 3 mil gap

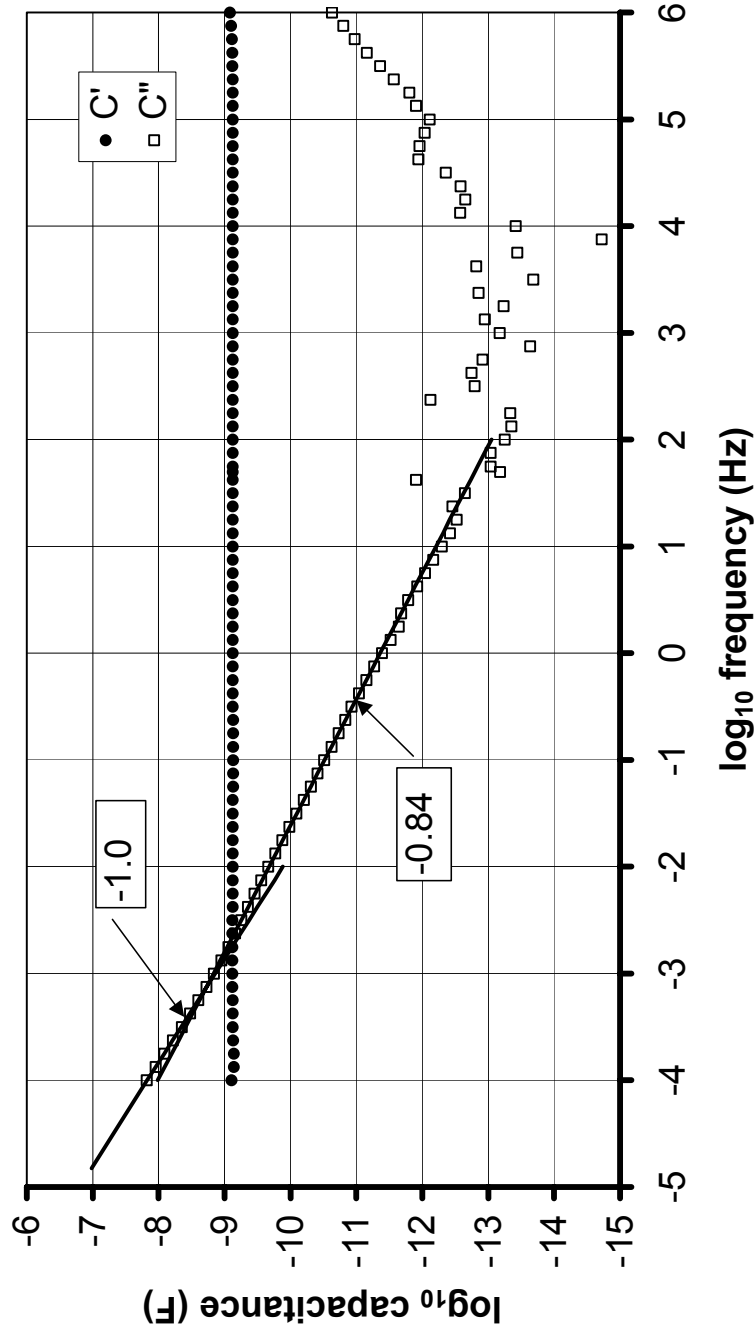

Figure 4: Real capacitance versus reciprocal inter-electrode gap for used silicone oil

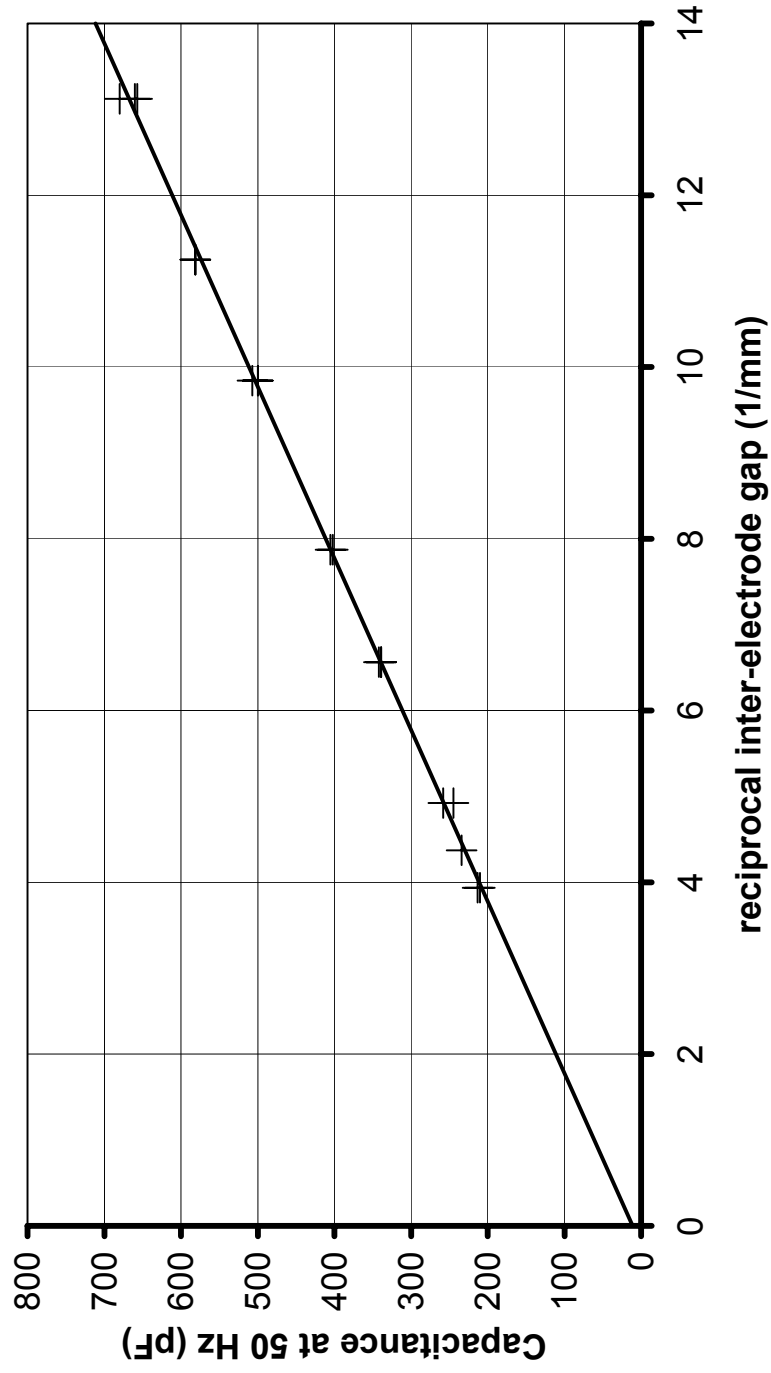

Figure 5: Wide band dielectric spectroscopy measurements on used oil at nominal 3 mil gap

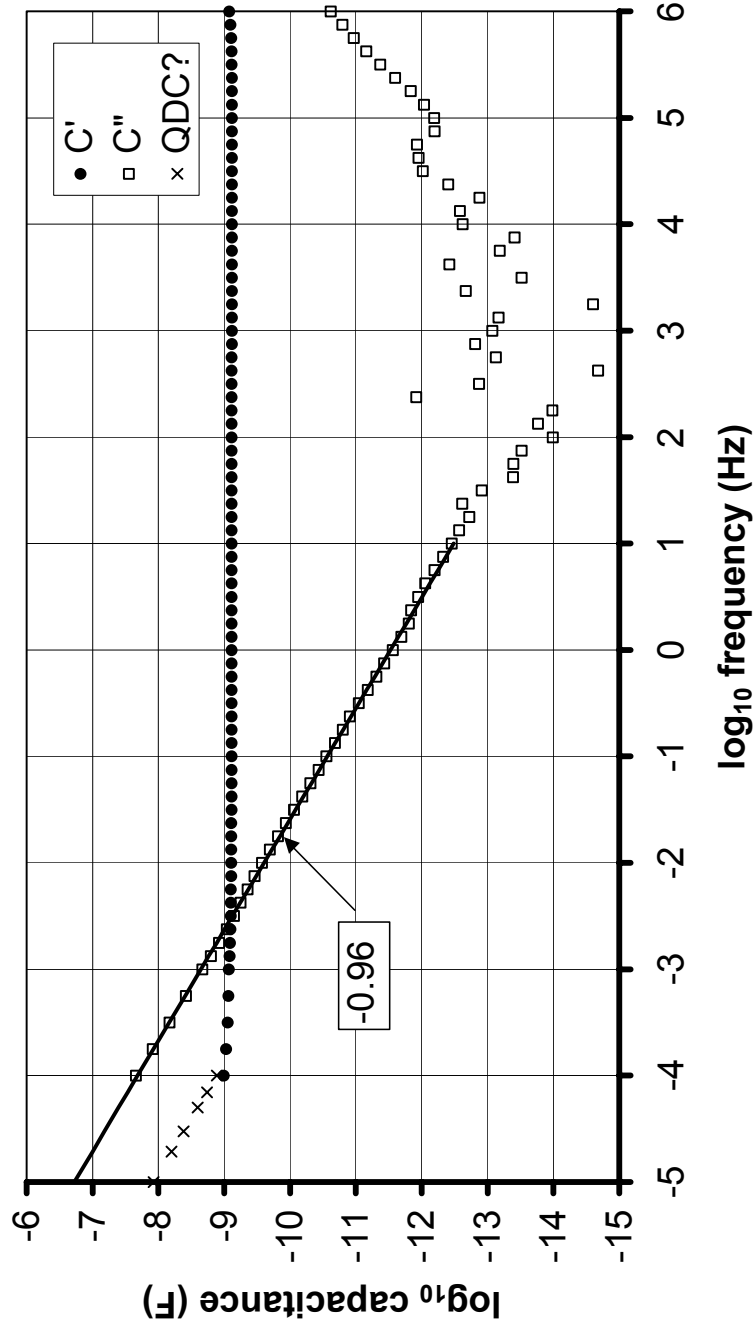

Figure 6: Real capacitance versus reciprocal inter-electrode gap for failed silicone

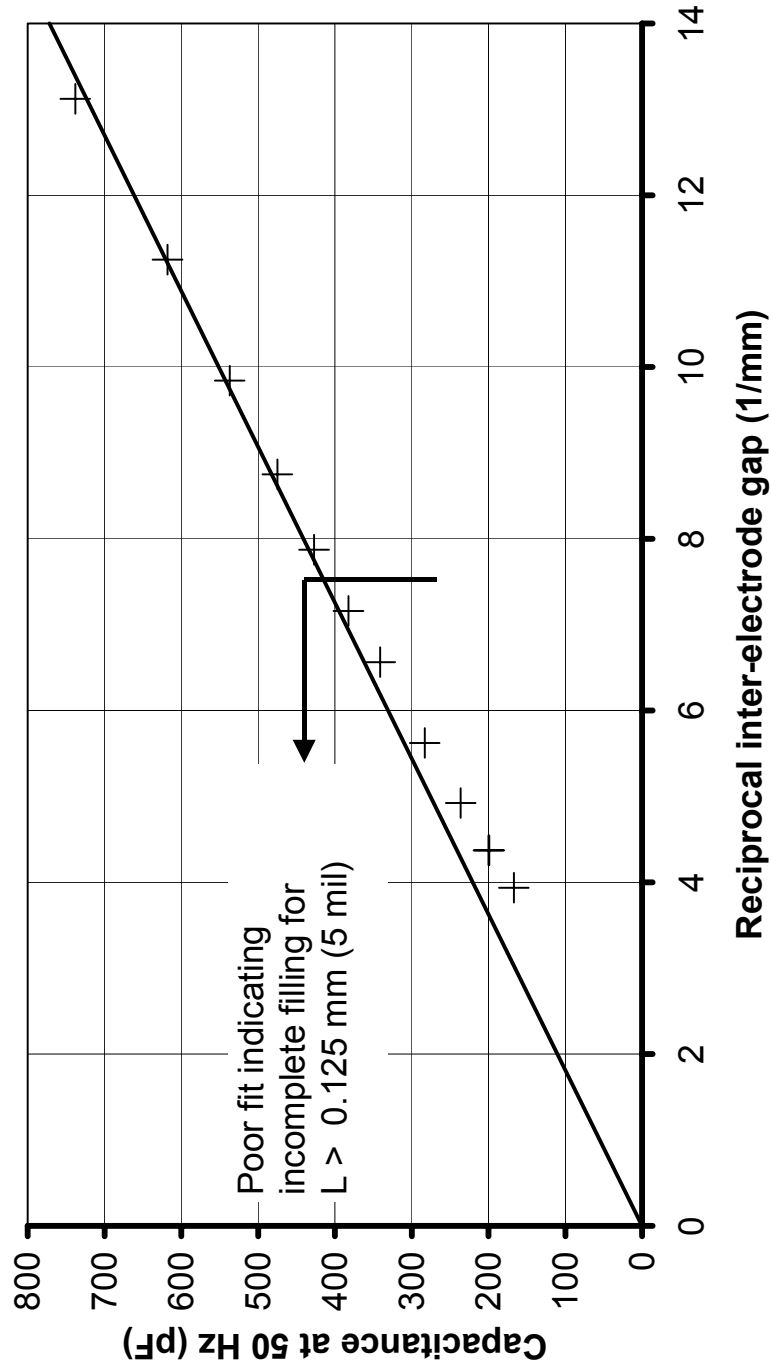

Figure 7: Wide band dielectric spectroscopy measurements on failed oil at nominal 3 mil gap

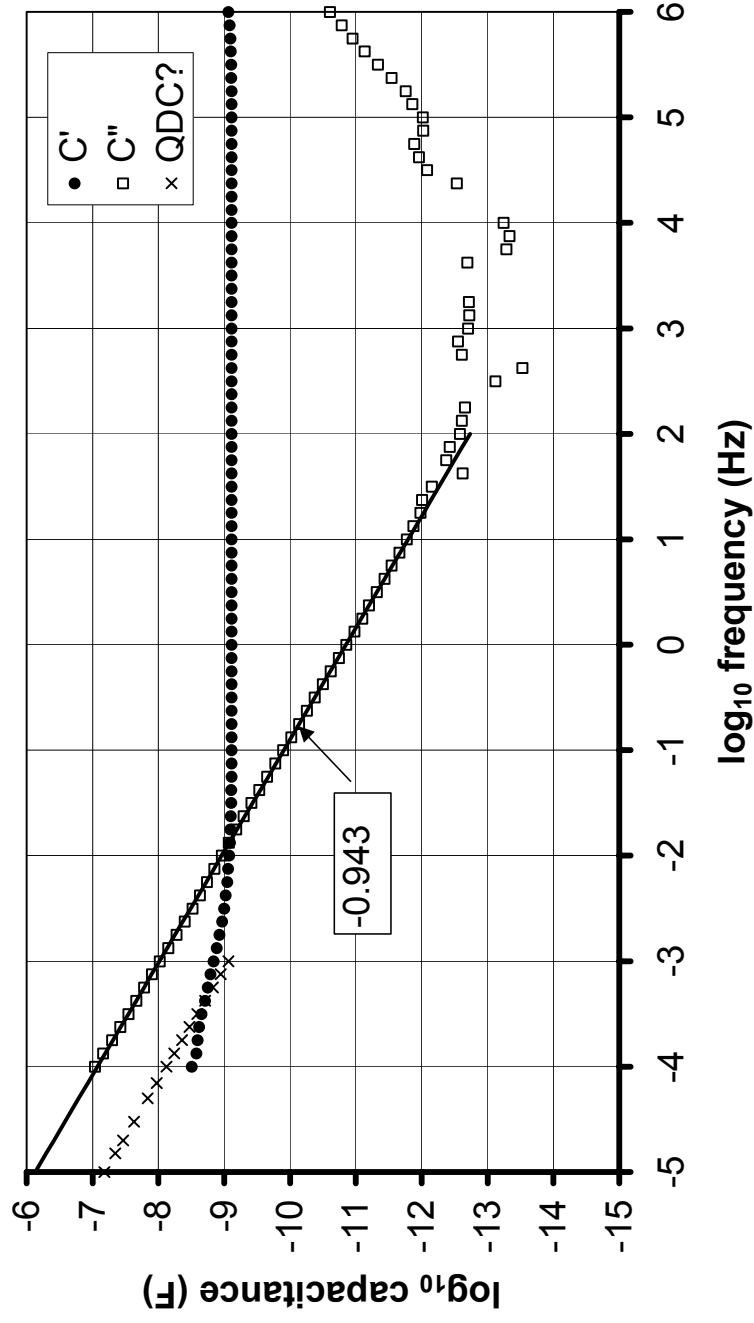

Figure 8: Imaginary capacitance (0.1 Hz) versus inter-electrode gap on bi-logarithmic axes for the failed oil. There are limited data points in which the oil completely filled the gap.

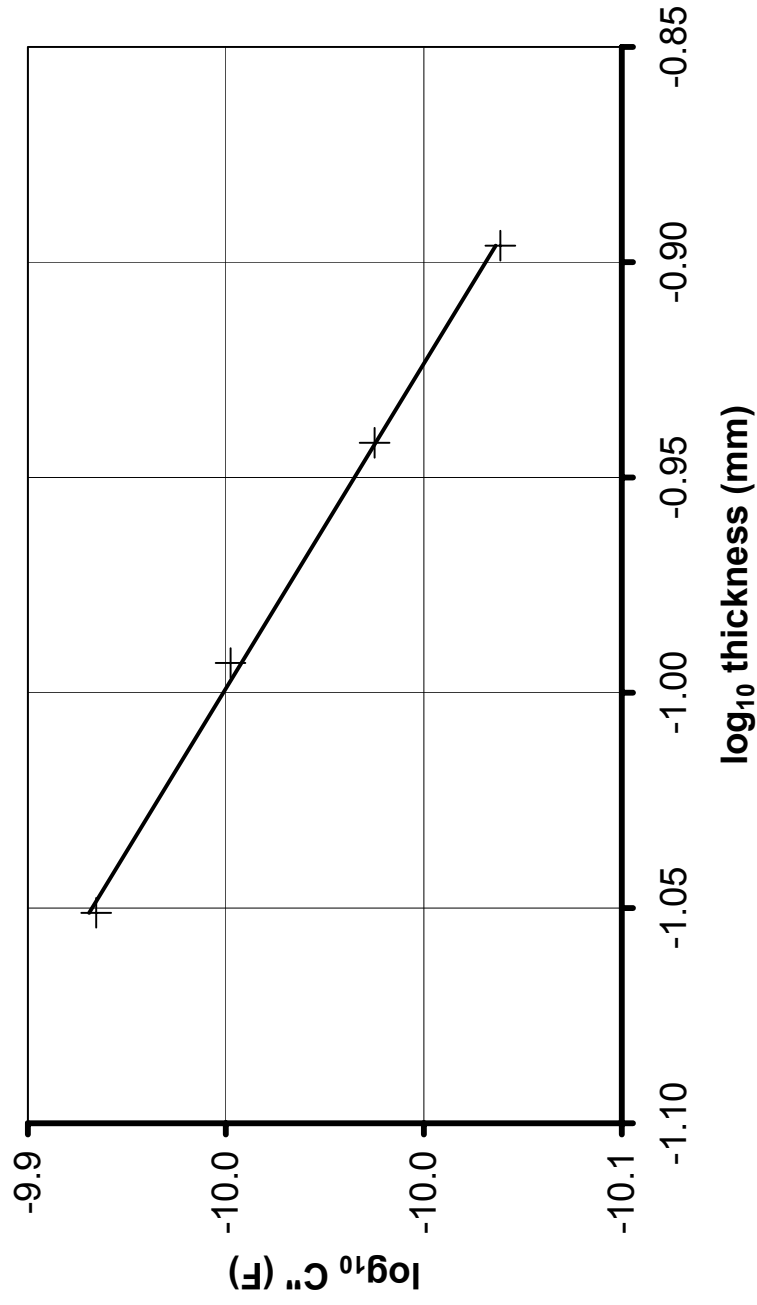

Figure 9

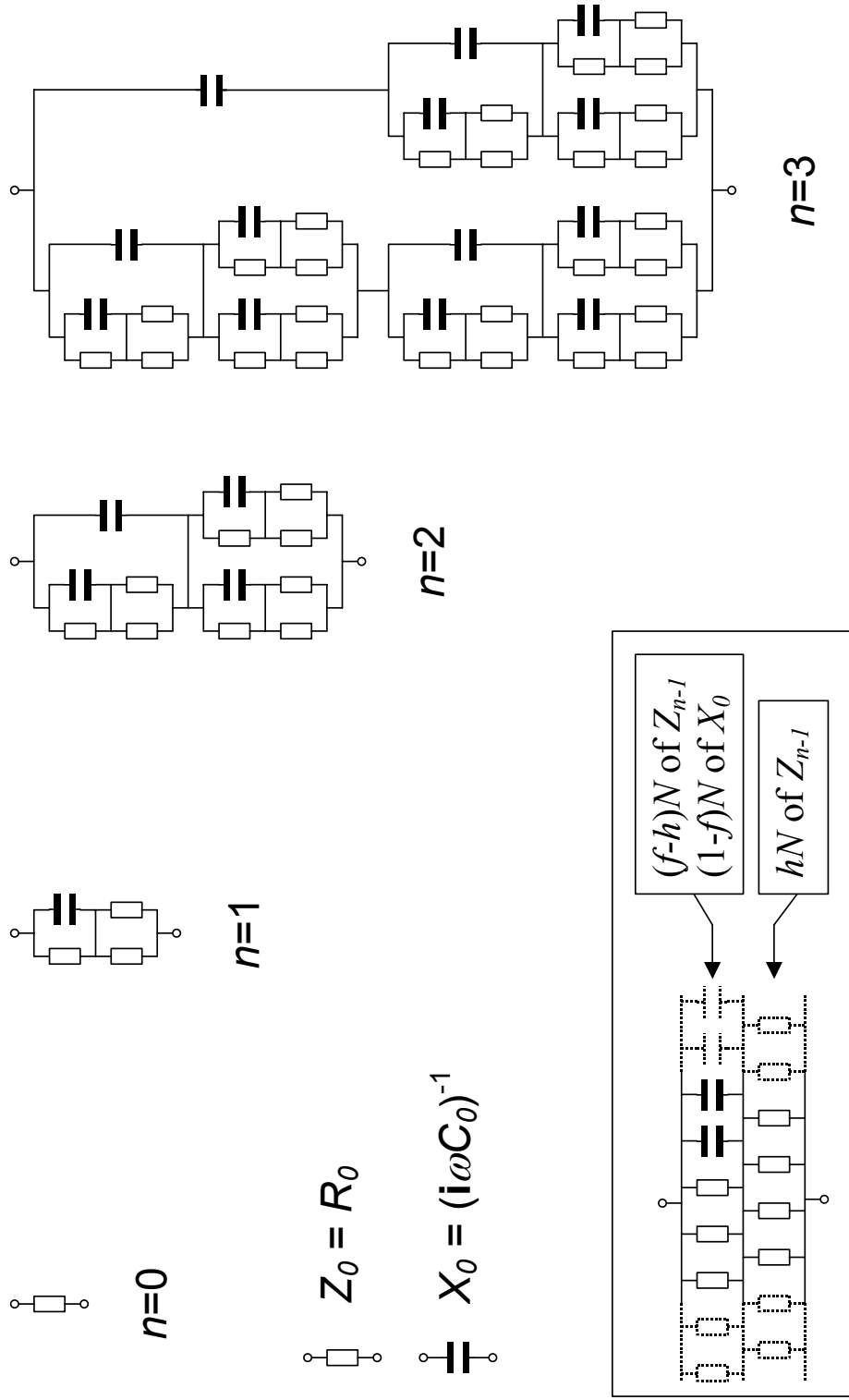

Figure 10: Schematic diagram showing typical FPR behaviour (after [4] in which various computed AC responses are given)

