



# The Behaviour of Steel Fibre Reinforced Concrete Material and its Effect on Impact Resistance of Slabs

Ahmad Bazgir

Submitted for the Degree of Master of Philosophy in Structural Engineering

City University London

School of Mathematics, Computer Science & Engineering

May 2016



CITY UNIVERSITY  
LONDON

**CityLibrary**  
Your space  
Your resources  
Your library

**THE FOLLOWING PARTS OF THIS THESIS HAVE BEEN  
REDACTED FOR COPYRIGHT REASONS:**

- p. 13:** Image from Bekaert Dramix.
- p. 17:** Image from Bekaert Dramix.
- p. 18:** Image of effect of aggregate size on fibre distribution.
- p. 25:** Image of stress lines in concrete under tension.
- p. 30:** Graph of air blast pressure response over time.
- p. 34:** Image of experimental results.
- p. 39:** Image of test set up for impact testing machine.

Ahmad Bazgir

MPhil in Structural Engineering

City University London

School of Mathematics, Computer Science &  
Engineering

Department of Civil Engineering

---

Supervisor:

Dr Feng Fu

---

## Table of Contents

ABSTRACT .....	10
CHAPTER ONE .....	11
Introduction .....	11
1.1. Aim .....	14
CHAPTER TWO .....	16
Literature Review .....	16
2.1. Steel fibre reinforced concrete and effect of fibre reinforcement .....	16
2.2. Mechanical properties of SFRC .....	20
2.2.1. Compressive strength .....	20
2.2.2. Flexural strength .....	20
2.2.3. Ductility .....	21
2.2.4. Fracture toughness .....	22
2.3. Advantages and Disadvantages of Steel Fibres in Concrete .....	23
2.4. Crack control .....	24
2.5. Load deflection behaviour of SFRC ground slabs .....	26
2.6. Failure of SFRC ground slabs .....	28
2.7. Behaviour of materials under blast load .....	29
2.8. Blast loading .....	31
2.9. Steel fibre reinforced concrete slab under impact loading .....	33
2.10. Numerical literature .....	43
2.10.1. Cracking models for concrete .....	47
2.11. Conclusion .....	47
CHAPTER THREE .....	49
Methodology .....	49
CHAPTER FOUR .....	50
Experimental Work .....	50

4.1.	Material and mix design .....	50
4.2.	Concrete mix design .....	50
4.3.	Mixing procedure .....	52
4.4.	Test set up.....	57
4.4.1.	Cube Compression Test.....	57
4.4.2.	Cylinder Compression Test .....	65
4.4.3.	Cube VS cylinder Compressive Strength .....	71
4.4.4.	Split Tensile Test.....	71
4.4.5.	Flexural Beam Test .....	78
4.4.6.	Relation between split tensile strength and flexural strength.....	88
CHAPTER FIVE.....		90
Conclusion and Recommendation.....		90
REFERENCES.....		92

## Table of Figures

Figure 1. Shapes of steel fibres (Bekaert Dramix).....	13
Figure 2. Crack controlling mechanism provided by steel fibres (Bekaert Company) .....	17
Figure 3. Effect of the aggregate size on the fibre distribution (Johnston, 1996).....	18
Figure 4. The three important parameters of a steel fibre .....	19
Figure 5. Stress lines in concrete under tension (Tatnall and kuitenbrauer).....	25
Figure 6. Comparison between SFRC and plain concrete ground slabs .....	26
Figure 7. Typical load displacement response of SFRC ground slab (Falkner and Teutsch, 1993).....	29
Figure 8. Air-blast pressure response over time (Hinman, 2003).....	30
Figure 9. Free field blast pressure probe set up arrangement and field blast test set up .....	32
Figure 10. Experimental results (Mahalingam et al. 2010).....	34
Figure 11. Experimental set-up for impact test (Madheswaran et al. 2014).....	35
Figure 12. Experimental set-up for impact test (Hrynyk et al. 2014) .....	36
Figure 13. Test set up for one-way slab specimens (Doo Yeol Yoo, 2009) .....	38
Figure 14. Test set-up for impact testing machine (Elavenil et al. 2003) .....	39
Figure 15. Cracking Pattern of Plates (Elavenil and Knight, 2012).....	40
Figure 16. FE Results: (a) Damage fringe for bottom of slab (b) deformed shape (Mokhatar and Abdullah, 2012).....	45
Figure 17. Concrete Constituents.....	51
Figure 18. (a) Addition of coarse aggregate (b) Addition of sand, (c) Dry constituents mixed uniformly, (d) Water added to the mixture .....	52
Figure 19. Adding steel fiber to the mix .....	52
Figure 20. Forms of slump .....	53
Figure 21. Measuring slump .....	53
Figure 22. Slump measurement after mixing.....	54
Figure 23. Covering inside the moulds with specific oil .....	55
Figure 24. (a) sample moulds on shaking table, (b) Concrete moulds.....	56
Figure 25. Covering of the specimen after casting with wet cloth.....	56
Figure 26. Concrete specimens cured in water tank .....	57
Figure 27. Cube compression test set up.....	58

Figure 28. Cube Compression Test Results – 21 Day .....	59
Figure 29. Cube Compression Specimen Results (21 Day).....	60
Figure 30. Cube Compression Specimen Results (21 Day)-continued.....	61
Figure 31. Cube Compression Test Results – 21 Day .....	63
Figure 32. Cube Compression Specimen Results (28 Day).....	63
Figure 33. Cube Compression Specimen Results (28 Day)-continued.....	64
Figure 34. Cylindrical Compression Test Set up. ....	65
Figure 35. Cylinder Compression Results .....	67
Figure 36. Plain concrete sample after the test .....	68
Figure 37. SFRC0.5 sample after the test .....	68
Figure 38. SFRC1.0% samples after the cylinder compression test .....	69
Figure 39. SFRC1.0% samples after the cylinder compression test .....	70
Figure 40. SFRC1.0% samples after the cylinder compression test .....	70
Figure 41. Split tensile test set-up .....	73
Figure 42. Split Tensile Strength Comparison.....	73
Figure 43. PC Samples after Split Tensile Test .....	75
Figure 44. SFRC0.5 Samples after Split Tensile Test .....	76
Figure 45. SFRC1.0% samples after split tensile test .....	76
Figure 46. SFRC1.5% samples after split tensile test .....	77
Figure 47. SFRC2.0% Samples after split tensile test .....	77
Figure 48. Arrangement of loading of test specimen (BS EN 12390-5:2000).....	78
Figure 49. Flexural Beam Test Set Up.....	78
Figure 50. Flexural Beam Test Results .....	80
Figure 51. Flexural Beam Test Results (Early stages).....	82
Figure 52. PC beam test results.....	83
Figure 53. SFRC1.0 Beam Test Results.....	84
Figure 54. SFRC1.0 Beam Test Results.....	85
Figure 55. SFRC1.5 Beam Test Results.....	86
Figure 56. SFRC2.0 Beam Test Results.....	87
Figure 57. Steel fibers bridging the concrete beam crack under flexure .....	88

## List of Tables

Table 1. Properties of fibres used in (Ong et al. 1999) .....	41
Table 2. Steel fiber properties .....	50
Table 3. Mix proportions of the concrete mixtures for 1m <sup>3</sup> .....	51
Table 4. Cube Test Results .....	59
Table 5. Cube Compression Test Results for 28 Days .....	62
Table 6. Cylinder Compression Test Results .....	66
Table 7. Cube vs cylinder compressive strength.....	71
Table 8. Cylinder Split Tensile Test Results.....	74
Table 9. Flexural Test Results.....	79
Table 10. Relation between split tensile strength and flexural strength .....	88



## **ACKNOWLEDGMENT**

I would like to acknowledge the instructions and support from my research supervisor Dr Feng Fu from School of Mathematics, Computer Science & Engineering, Department of Civil Engineering , City University London, during my M-Phil study. This study has made me to the person I am at present, not only in relation to my professional career but also with respect to my individual development.

Last, but not least, I would like to thank my family especially my parents and friends for the encouragements and general understanding of my absence, physically as well as mentally, every now and then during my studies. Without your continuous support it would have been impossible for me to finish my studies.

I certify that this project is wholly my own work and that all material extracted from other sources is clearly referenced.

I grant powers of discretion to the City University Librarian to allow this thesis to be copied in whole or in part without further reference to me. This permission covers only single copies made for study purposes, subject to normal conditions of acknowledgement.

## **ABSTRACT**

Concrete structures are usually subjected to both static as a long term and dynamic as a short term loads. The impact resistance of plain concrete is low and that's mainly due to a fairly low energy dissipating features and inadequate tensile strength. To compensate for the weak tensile properties of the concrete the reinforced concrete is used and it has a better potential as a practicable structural material for such application under extreme loads such as impact. However, concrete is a developing material and the relevant studies towards the change and development of concrete which researchers have carried out to date reveals that the developed concrete improves the behaviour of structural member more when compared to conventional concrete. Fibre Reinforced Concrete (FRC) material is a developed concrete that has been proposed to improve the tensile behaviour of the concrete using fibres in the concrete mix. Steel Fibre Reinforced Concrete (SFRC) is popular FRC material that is being studied to improve the structural behaviour of members under different load conditions.

This study aims to investigate and examine the structural behaviour of steel fibre reinforced concrete material at different volume fraction of the fibers. Experimental work is conducted for this research to obtain results on the behaviour of SFRC. The experimental work consists of testing concrete under tension, compression and flexure.

## CHAPTER ONE

### Introduction

Plain concrete slabs are known to have low strength and low strain capacity, however these structural properties could be improved by addition of fibres, allowing the thickness of the layer to be reduced. There are different fibres that are used in the concrete namely glass fibre, steel fibre, synthetic fibres and natural fibres. The improvement in the material behaviour of the fibre reinforced concrete depends on dosage and characteristics of the used fibres.

The main important effect of fibres as reinforcement is to influence and control the tensile cracking of concrete. Yet, the fibre reinforced concrete is known to have considerable impact on the slab cost owing to reduced thickness needs, prolonged useful life and reduction in maintenance costs.

Amongst the fibres mentioned, steel fibres are the most researched and more practical. Steel fibre reinforced concrete is a type of concrete that contains randomly oriented discrete steel fibres. The main aim of addition of steel fibres to concrete is to control crack widening and crack propagation after the concrete matrix has cracked. By control of the cracking the mechanical properties of the composite material as a result will be improved significantly.

Addition of randomly distributed steel fibres improves concrete properties, such as static flexural strength, ductility and flexural toughness. SFRC has been largely used in airport pavements due to the extreme and damaging loads acting on the pavement. (Johnston, 1982) Some other examples of the structural and non-structural applications of SFRC are hydraulic structures, airport and highway paving and overlays, industrial floors, refractory concrete, bridge decks, concrete linings and coverings, and thin-shell structures. The elasticity modulus of steel fibres is as high as 210 MPa providing very high tensile strength with minimal deformation. The large number of fibres used for concrete members enables a uniform distribution of fibres through the compound, thereby creating a composite material possessing homogeneous mechanical behaviour. They provide a cohesive mix, creating a three-dimensional reinforced net system (Tokgoz, 2012). The important characteristic in FRC material is the bond between the fibers and the matrix. Fibres are designed in

different geometries to increase the bond and interfacial friction between aggregates and cement paste. Fibre texture such as the end-hooked fibres improve the bond between the fibres within the matrix, thus increasing the necessary force required to pull out the fibre from the concrete. The forces induced in a SFRC when subjected to load are redistributed within the concrete, which restrains the formation and extension of cracks. The result is a more ductile reinforced concrete which is able to maintain a residual capacity in the post-cracking phase (Tokgoz, 2012). Thus resulting in an increased load-carrying capacity, improved shear and bending strength of concrete, superior flexural ductility, toughness, and fatigue endurance. In addition, SFRC has higher life cycle and the maintenance requirements are reduced resulting in lower costs. (Elsaigh, 2001) Another advantage of the SFRC is that at an adequate volume fraction they can replace conventional steel reinforcement when designed properly and it reduces the construction time since the steel fibres are added directly as one of the concrete mix constituents, hence no steel fixing or adjustment is required. (Association of Concrete Industrial Flooring Contractors, 1999)

The research on the SFRC members and slabs under static loads showed that they can provide equivalent performance compared to conventionally reinforced concrete slabs when equivalent amounts of reinforcement is used. (Bischoff et al., 2003)

Researchers during recent years have stated that steel fibres significantly improve the impact resistance of concrete material (Nataraja, 2005) making it a suitable material for structures subjected to impact loads. Overall, the above factors suggest that SFRC is potentially the most beneficial type of material from engineering and economical prospective to be considered for structural slabs subjected to high loads. The aim of this study is explained below.

Steel fibre reinforced concrete (SFRC) is a composite material similar to normal concrete but with fibres as part of mixture constituent. It is made of cement, fine aggregate, coarse aggregate and other components or admixtures that can commonly be used in concrete with dispersion of discrete small steel fibres. It has been used in concrete since the early seventies and for different applications like slab on ground, pavements, and bridge decks. Fibres have different geometries also they vary in

dimensions. The length of fibres could vary from 25mm to 75mm and the diameter from 0.5mm to 1.3mm. Different fibre shapes are illustrated in Figure 1.

The addition of fibres to concrete has shown improvement in concrete flexural strength, toughness, ductility, impact resistance, fatigue strength and resistance to cracking. In addition the deformation at peak stress is much greater than plain mortar. Fibres help to alter the behaviour of concrete after the initiation of cracking. The crack bridging behaviour of fibres is what improves the ductility of matrix.

The main advantageous property of SFRC is its superior resistance to cracking and crack propagation. The fibres are able to hold the matrix together even after extensive cracking due to its bridging effect. SFRC has the ability to arrest cracks; therefore fibre composites retain increased extensibility and tensile strength, both at first crack and at ultimate stress. The net result this is the fibre composite will have a marked post-cracking behaviour and ductility which is unremarked in ordinary concrete in which the tension post crack is negligible. The material is therefore transformed from a brittle to a ductile type of material which would increase substantially the energy absorption characteristics of the fibre composite and its ability to withstand repeating applied load such as shock or impact loads.

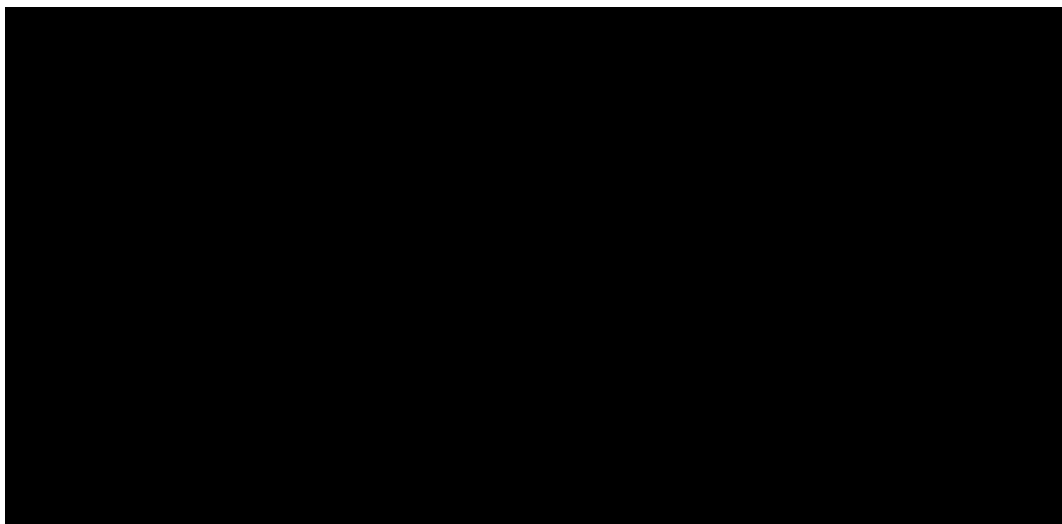

Figure 1. Shapes of steel fibres (Bekaert Dramix)

Steel fibres are generally made of carbon steel or stainless steel, where the latter is used for structures that require corrosion-resistant fibres. Tensile strengths may be in the range 200- 2600 MPa and ultimate elongations between 0.5% and 5%. Although a tensile strength is significantly higher than that of the matrix is needed, very strong fibres may have an adverse effect on the reinforcing efficiency; pull-out experiments have shown that in low-strength matrices high tensile strength steel fibres cause more severe matrix spalling around the fibre exit point.

### **1.1. Aim**

Additional strengthening method is required to improve the resistance of concrete structures under the extreme loads. The aim of this study is to expand upon the findings of the previous researchers and investigate the strengthening effect of fibers on concrete and find out the mechanical behaviour of steel fibre reinforced concrete as a material with specific end hooked steel fiber.

The main objectives of this study are:

- Review previous research on FRC material and structural behaviour of structural members.
- Review previous experimental research on the impact behaviour of slabs and use of fibers.
- Review the numerical studies conducted by previous researchers to analyse the impact behaviour of slabs.
- To evaluate the effect of end hooked steel fibers on concrete mechanical behaviour consisting compressive strength, split tensile strength, flexural strength, and ductility.
- To examine the effect of fiber volume fraction on SFRC material performance.
- To make a comparison for the performance of concrete with and without steel fibre reinforcement on the material levels both graphically and qualitatively.

Overall, this thesis aims to firstly outline the previous research that has been conducted on steel fiber reinforced concrete material and impact behaviour of structural slabs and plates that have been studied so far. In Chapter three the methodology used for conducting this research is explained. Then the experimental

work on materials consisting of plain concrete and SFRC is thoroughly explained and results are presented in Chapter four. At the end of this thesis a conclusion based on the experimental results has been drawn and further work for future projects has been recommended.



## CHAPTER TWO

### Literature Review

This Chapter summarises the work that has been conducted to date by other researchers on the steel fiber reinforced concrete and its structural performance focusing on the impact load.

#### **2.1. Steel fibre reinforced concrete and effect of fibre reinforcement**

There are several types of steel fibres that have been used in the past. Apart from other mix constituents, there are four important features of steel fibre that are found to have an effect on the properties of the composite, namely: type (i.e. shape), volume fraction, aspect ratio (the ratio of length to the diameter of the steel fibre) and orientation of fibres in the matrix. Recently, optimisation of these parameters have been studied to improve the fibre matrix bond characteristics and to enhance fibre dispensability (Soroushian and Bayasi, 1991). It was found that SFRC containing hooked end stainless steel wires has superior physical properties compared to straight fibres. This was attributed to the improved anchorage provided and higher effective aspect ratio than that of the equivalent length of the straight fibre (Ramakrishnan, 1985)

Laboratory scale tests conducted by many agencies and researchers indicate that the addition of steel fibres to concrete significantly increase the total energy absorbed prior to complete separation of the specimen (Johnston, 1985). The presence of steel fibres was also found to improve fatigue properties, flexural strength, shear strength and impact strength (Johnston and Zemp, 1991, Morgan and Mowat, 1984). The improvement of mechanical properties of SFRC is attributed to the crack controlling mechanism. Bekaert Company suggested that there are two mechanisms that play a role in reducing the intensity of stress in the vicinity of crack. These mechanisms are:

1. The higher load resistance of steel fibres near the crack tip due to their higher young's modulus compare to the surrounding concrete. (Figure 2.a)
2. Steel fibres bridge the crack and transmit some of the load across the crack. (Figure 2.b)

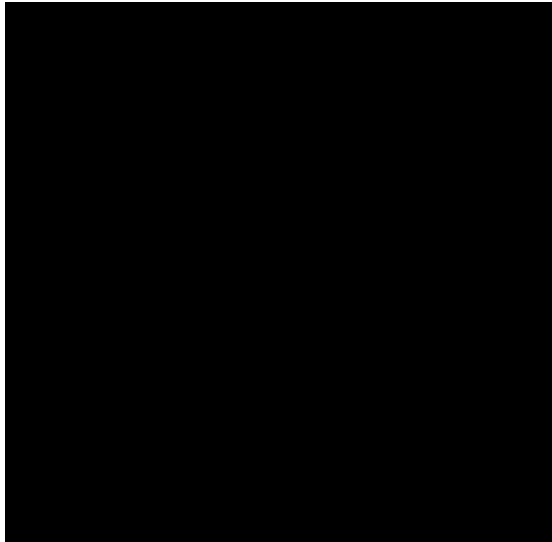

(a) Steel fibres at the tip of crack resist the crack

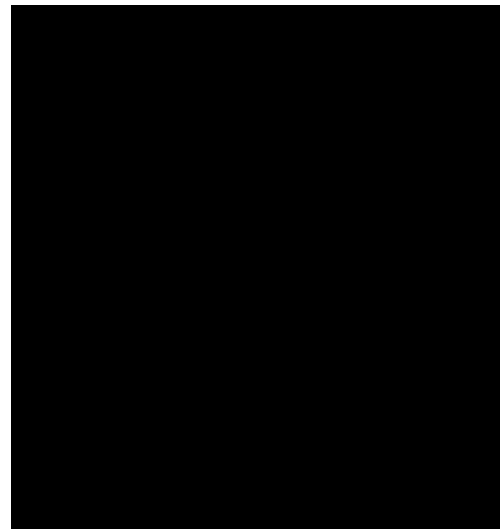

(b) Steel fibres across the crack transmit some tension

Figure 2. Crack controlling mechanism provided by steel fibres (Bekaert Company)

The ability of steel fibres to resist crack propagation is primarily dependant on the bond between the concrete and fibres as well as fibre distribution (i.e. spacing and orientation). The bond between the concrete and fibres is the mechanism whereby the stress is transferred from the concrete matrix to the steel fibres.

Steel fibre reinforced concrete (SFRC) appears stiffer (lower slump) compared with conventional concrete without fibres even when the workability (judged by any test using vibration) is the same (Johnston, 2001). Steel fibers tend to interlock together. Vibration is encouraged to increase the density, to decrease the air void content and to improve the bond with reinforcement bars. In spite of a stiff appearance, a well-adjusted fibre mixture can be pumped (ACI 544, 1993). “The size of the fibres relative to that of the aggregates determines their distribution (Figure 3). It is recommended to choose fibres not shorter than the maximum aggregate size to be effective in the hardened state. Usually, the fibre length is 2-4 times that of the maximum aggregate size.” (Johnston, 1996 and Coetze, 1990) It is recommended to reduce the volume of coarse aggregates by 10% compared with plain concrete to facilitate pumping. The initial slump of plain concrete should be 50-75 mm more

than the desired final slump; to obtain the desirable workability, super plasticiser should be added to the mixture rather than excess water (Johnston, 2001).

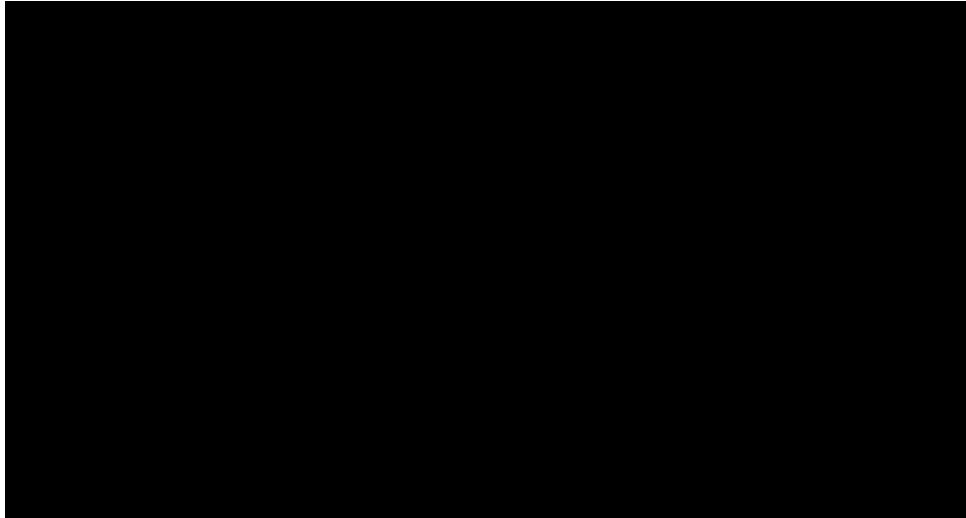

Figure 3. Effect of the aggregate size on the fibre distribution (Johnston, 1996)

The size, the shape and the content of the coarse aggregates as well as the geometry and the volume fraction of steel fibres affect the workability of concrete. At a given fibre diameter and volume fraction, compact ability is linearly related with the aspect ratio ( $l_f/d_f$ ) of the fibres. The relative fibre to coarse aggregate volume and the ‘balling up’ phenomenon govern the maximum possible content of steel fibres.

The performance of different types of steel fibres can be characterised by the following three parameters (Figure 4):

- The aspect ratio ( $L/D$ )
- The tensile strength
- The bond between fibres and the matrix (dependant on fibre type)

Steel fibres, compared to traditional fabric reinforcement, have a tensile strength typically 2-3 times greater and a significant greater surface area to develop bond with the concrete matrix (ACIFC, 1999). These parameters will affect the performance of steel fibre in concrete as well as the interaction between fibres and concrete matrix. For example, a steel fibre with high tensile strength which has bad bond in concrete most likely will not perform as the steel tensile strength could permit. The combination of these three parameters will give a toughness value at a certain dosage. However, for different dosages (volume fraction of fibres in concrete), the toughness value for a specific steel fibre will vary. (See section 2.2.4)

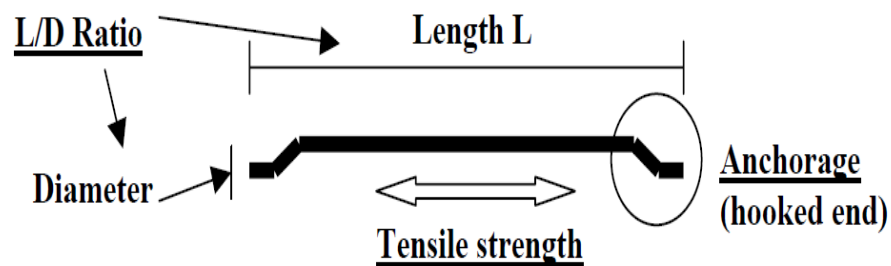

Figure 4. The three important parameters of a steel fibre

Steel fibre concrete is mainly used for industrial floors and pavements applications. “In the United Kingdom, more than 2 million m<sup>3</sup> of steel fibre reinforced slabs have been installed over the past ten years” (ACIFC, 1999). The stresses induced on a concrete slab are complex depending on the load that is applied to the member. In addition, there are number of stresses which are difficult to measure, arising from a number of causes such as shrinkage and thermal effects, sharp turns from fork lift trucks, and impact loads (Knapton, 2003).

Regarding the economical aspect, the main energy component of concrete slabs is the energy used for manufacturing cement and steel reinforcement. Although current material and energy prices already indicate that concrete slabs can be more cost-effective but the energy efficiency and further reduction in the total structural element dimensions could be obtained in the production of concrete slabs.

## **2.2. Mechanical properties of SFRC**

Fibres are known to enhance the mechanical performance of concrete with regard to its tensile and shear strength, toughness, ductility, durability, fatigue and shrinkage resistance (Gopalaratnam, 1991). Following are an overview of these characteristics.

### **2.2.1. Compressive strength**

The effect of steel fibres on the concrete compressive strength is much debated in literature. It has been found by many researchers (e.g. Winterberg, 1998) that the inclusion of steel fibre in concrete increases its compressive strength value. This increase ranges between marginal and significant increases in compressive strength. The effect of fibres on the compressive strength is attributed to two stabilising actions according to Gröbl et al. (2001). First, a larger amount of pores in the concrete admixture, which decreases the compressive strength and second factor, would be the fibre bridging effect across the micro cracks, which results in an increased compressive strength. The concrete compressive strength of the material depends on the magnitude of these effects and it may change. The effect of steel fibres on the compressive strength therefore depends on the concrete mixture, the kind and amount of steel fibres and the manufacturing process. Despite the increase in the compressive strength of the concrete, it is unclear whether the addition of steel fibres influences the rotation capacity of plastic hinges. It is generally agreed that steel fibres enhance the ductility of concrete in compression (Gröbl et al., 2001). Steel fibres as well as stirrup reinforcement increase the confining capacity of concrete. This is reflected in the stress-strain relationship of concrete with a more ductile post-peak behaviour. For steel fibres, the orientation of the fibres needs to be perpendicular to the compressive loading in order to be effective. It is therefore expected that the addition of steel fibres increases the rotation capacity of plastic hinges in case of concrete failure as a result of the increase of concrete ductility in compression.

### **2.2.2. Flexural strength**

The low flexural strength of plain concrete could be overcome and improved by the addition of steel fibres. A review of the literature on SFRC indicates that in general the addition of short, randomly-oriented steel fibres increase the flexural strength of plain concrete by about 1.5 to 3.0 times, taking into account the type and content of

the steel fibres. Roesler (2003) used different type of fibres and analysed the flexural resistance of beams and large scale slabs on ground and concluded that discrete fibres contribute to the flexural strength of concrete slabs beyond what is predicted by beam tests. The slabs flexural strength was 1.8 to 2.2 times greater than the beam flexural strength for the fibre reinforced concrete and 1.4 times greater for the plain concrete. The flexural cracking load of fibre reinforced concrete slab was 25 to 55 percent higher than the plain concrete slab. The addition of synthetic fibres increased the “flexural cracking load relative to plain concrete slabs by 30 percent. The crimped steel fibres at  $39 \text{ kg/m}^3$  showed the greatest increase to the flexural strength (55 %) which was attributed to its higher concrete flexural strength” with the inclusion of steel fibres.

### **2.2.3. Ductility**

FRC is known to provide higher ductility than ordinary concrete. Ductility is the ability of concrete to undergo maximum plastic deformation before collapse. It is considered a good warning indicator before failure. Mahalingam et al. (2013) studies the ductility behaviour of steel fibre on concrete beams. They used steel fibre content of 0.5, 1 and 1.5 % by volume. They concluded that the ultimate load carrying capacity of concrete beams were improved by 14, 20 and 32%, respectively, compared to conventional reinforced concrete beam. Ductility could also be increased using synthetic fibres (Roesler, et al., 2006, Sounthararajan and Sivakumar, 2013).

However, ductility in concrete beams could only be achieved with higher dosage of fibre added at approximately 5% but the effect of fibres on early-age shrinkage is not well established at this amount. Considering that only low-dosage amount of fibre are needed, ductility would have very little effect on early-age shrinkage.

The Modulus of Rupture (MOR) beam tests conducted by Tadepalli et al. (2010) revealed that “the non-fibrous beams had no ductility. In these beams, once the maximum tensile stress was reached, the beams failed suddenly without any warning.” However for the SFRC, “after the onset of initial crack at the beam bottom, the specimen did not fail suddenly, but it demonstrated considerable residual strength.”

#### **2.2.4. Fracture toughness**

Fracture toughness measures the energy absorption capacity of material under static or dynamic load. Fracture toughness is used to evaluate the post-cracking behaviour for concrete at the deflection at mid span. Specimen toughness is a measure of the energy absorption capacity of the test specimen and it is related to ductility. In SFRC the amount and type of fibres in the concrete influence this property of the material in different ways.

By adding steel fibre in concrete its post-crack behaviour or toughness of SFRC is improved, which is considered as one of the main effect of fibres in concrete matrix. This effect is useful regarding design of hyper static construction such as slab on ground. When the first crack appears, the fibres in concrete start to act and have the ability to absorb and redistribute the loads, hence redistribute the energy, so that the SFRC will still be able to bear loads even after the formation of cracks. In fact, SFRC has a ductile behaviour or toughness and therefore, that excess of flexural capacity from the plastic phase (i.e. post-crack behaviour) can be used for design of structure when deformation is essential and must be controlled such as in the design of slabs or for structures where deformations is important in the design such as underground linings. The higher fracture toughness is the reason for higher load capacity of SFRC slab on ground when compared to a conventional concrete slab with the same thickness.

Balaguru et al. (1992) studied the effect of fibre length and stated that the length of the fibre did not have significant effect on the toughness for steel fibres with hooked ends.

Tadepalli et al. (2010) studied the effect of different steel fibres at two 0.5% and 1.5% volume fraction of steel fibre and it was concluded that plain concrete did not demonstrate any toughness since it didn't have any residual strength. The mix with short fibres at the dosage of 1.5% had the greatest toughness value.

Overall, both steel and synthetic fibres improve the concrete fracture toughness. The improvement depends on the dosage amount but in most cases the fracture toughness increases with increasing dosage rate.

Many literature reports on how toughness is affected by the fibre type, dosage, fibre material properties, and bonding conditions are available in more details in ACI 544 report and elsewhere. (Roesler et al., 2006, Sravana et al., 2010 and Richardson et al., 2010)

Yazici et al. (2013) studied the mechanical properties of steel fibre reinforced concrete with 0.5%, 1.0% and 1.5% volume fraction of fibres. The aim of the research was to identify the mechanical losses in terms of the SFRC's compressive strengths and splitting tensile strengths following the effect of the impact. 50 kg mass was freely dropped onto the specimens in order to produce a certain amount of energy. The impact tests were repeated up to the failure and crushing of the specimen. The best performance under compressive strength was obtained for SFRC with  $l/d=65$ , while SFRC with  $l/d=80$  showed the best performance under splitting tensile strength. Long fibres had more positive effect on the compressive strength of the material. The volume fraction of 1.5% showed the best performance under impact load compared to other SFRCs. Overall, it was concluded that the steel fibres increased the impact fracture energy of the steel fibre concrete (SFRCs) by 3–23 times compared to plain concrete.

### **2.3. Advantages and Disadvantages of Steel Fibres in Concrete**

The advantage of using steel fibre can be summarized as follow:

- Produce more ductile concrete with a smaller number of cracking
- Reduction of the influence of shrinkage cracking
- High tensile strength
- High compressive strength
- Higher economically efficient compared to conventional steel solutions and enhance costs with lesser fibre amount
- Reducing schedule time due to fast installation
- Reduce the permeability in concrete, which ensures protection of concrete due to the negative effects of moisture
- Easy material handling
- High durability
- Can replace wire mesh in most elevated slabs.



Disadvantage:

- There are problems involved in attaining uniform distribution of fibres and dependable concrete properties
- At aggressive exposure condition the corrosion of the surface could take place, influencing the look of the surface
- The use of SFRC requires more accurate configuration as opposed to normal concrete
- Reduced workability

Though, as the amount of fibres is increased, the workability of the concrete is influenced. Therefore, special techniques and concrete mixtures are used for steel fibres such as addition of super plasticizer. Finishing problem may arise if proper techniques and proportions are not used, with the fibres coming out of the concrete.

#### **2.4. Crack control**

Steel fibres effectively limit the extension of micro-cracks which are always present in concrete (see Figure 5). In concrete without fibres, tension cannot be transmitted across the crack, that is, once the tensile capacity of the plain concrete is exceeded, the micro-crack will extend rapidly resulting in brittle failure. The action of the steel fibres in a concrete slab is to reduce the concentration of stresses near the micro-cracks by:

- Fibres bridging the crack and therefore transmitting some of the load across the crack
- Fibres near the crack tip resisting more loads owing to their higher modulus of elasticity compared to that of the surrounding concrete.

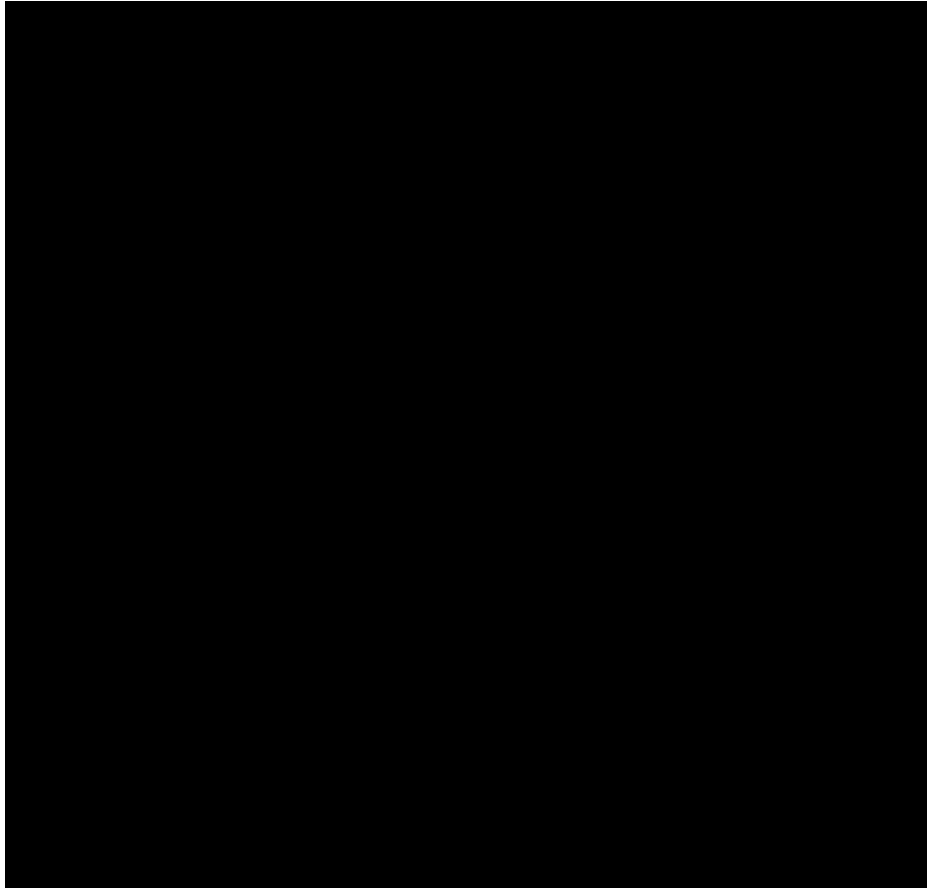

Figure 5. Stress lines in concrete under tension (Tatnall and kuitenbrauer)

The fibre anchorage will effect on the ductile behaviour. If the anchor is too uneven then the fibre will fail in a brittle manor. The anchorage must have the following concepts:

- Allow the fibre to progress to its full potential i.e. reach maximum stress
- start to slip earlier than the fibre breakage to avoid brittle failure
- Absorb energy as the fibre is being pulled out

In the case of floor slabs, a crack is formed where the ultimate stress in the floor is exceeded locally. Steel fibres cause the crack to behave as a hinge, resulting in a redistribution of stresses. Unlike a broken zone in a brittle material, this hinge can still resist stresses depending on the type and dosage used and thus increases the load bearing capacity of the member.

## 2.5. Load deflection behaviour of SFRC ground slabs

Extensive research has been carried out to investigate the effect of the steel fibres on the load capacity of ground slabs (Kaushik et al. 1989, Beckett, 1990, Falkner and Teutsch, 1993, Elsaigh, 2001, Bischoff et al. 2003, Chen, 2004). In these studies, full scale slab tests were conducted to compare the behaviour of centrally loaded SFRC slabs to plain concrete or welded wire fabric reinforced concrete slabs. It was shown that by adding steel fibres to the concrete mix the load carrying capacity of the ground slabs will increase significantly. Figure 6.a and Figure 6.b show the load displacement ( $P-\Delta$ ) responses from two investigations conducted by Chen (2004) and Falkner and Tuetch (1993) respectively. It is prominent that SFRC containing hooked-end steel fibres yields greater load carrying capacity compared to both plain concrete and SFRC containing mill-cut fibres (straight fibres having a relatively low tensile strength). Figure 6 shows that the addition of  $30 \text{ kg/m}^3$  of hooked-end steel fibres resulted in greater load carrying capacity for the SFRC ground slab compared to addition of  $20 \text{ kg/m}^3$  of similar steel fibres type.

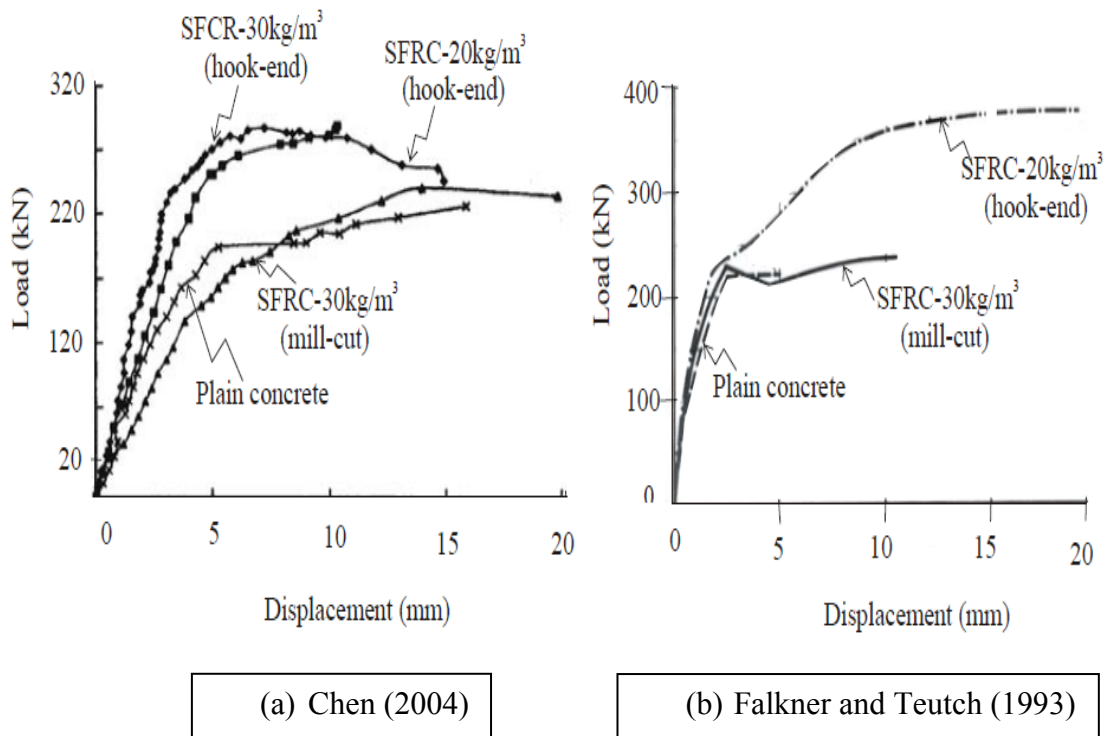

Figure 6. Comparison between SFRC and plain concrete ground slabs

Several explanations for the increased carrying capacity of SFRC ground slab have been suggested. As well as the structural ductility of the statically indeterminate slab, it has been recognised that the post cracking strength of steel fibre reinforced concrete is the reason behind the increased load carrying capacity of SFRC ground slabs ( Kearsley and Elsaigh, 2003).

The result from the static tests on the full-scale ground slabs indicated that an appreciable thickness reduction, depending on steel content, is possible for SFRC ground slabs when compared to counterpart plain concrete slabs. Indeed it was found that about 16% thickness reduction is possible when  $15\text{kg}/\text{m}^3$  of hooked-end steel fibres were used (Elsaigh, 2001).

Bischoff et al. (2003) stated that the thickness reduction is justified by the following arguments:

1. The post cracking strength of the SFRC allows for redistribution of stresses leading to an increased load carrying capacity and therefore the slab thickness can be reduced.
2. Steel fibres significantly increase the flexural capacity and therefore the slab thickness can be reduced.
3. Steel fibres will improve the fatigue resistance of the concrete and can lead to thinner slabs as the allowable stress is increased.

SFRC is deemed to be a superior material for concrete roads due to its improved mechanical properties compared to plain concrete. Although support provided by the subgrade means that bending stress in slabs is generally low, the flexural capacity of the slab remains an important aspect to be considered. This is especially crucial when bending stresses increase significantly due to unnoticed subgrade erosion, as is common in the case when the subgrade subside at the pavement corner or edge. In conventional reinforced concrete slabs, the steel reinforcement is placed between the mid to two third depth of the slab to mainly resist stresses induced by changes in the environmental conditions (Paramasivam et al. 1994). The load carrying capacity of concrete slab can be enhanced by placing the reinforcement in the bottom of the slab. Thus, allowing the concrete in the bottom surface to crack and the reinforcement there to withstand the positive moment. Top reinforcement can also be provided especially at corners and edges to resist negative moment.

Fibre reinforced concrete has many applications due to its increased strength and ductility. However, this type of concrete is not widely used due to ongoing research on its long term properties. FRC can be used in beams to take advantage of the higher ductility and tensile strength of this material for better crack control and material cost saving. Structural elements can be produced with fibres completely replacing conventional reinforcement. Generally, the Main use of fibre reinforcement has been in applications such as highways, pavements, runways, tunnels, deck slabs and wall panels in buildings.

## **2.6. Failure of SFRC ground slabs**

Fibre reinforced concrete can be used to make slabs for nearly any applications including precast slabs, parking garages, slabs surface repairs and industrial floor slabs. Significant advantage is realised when conventional reinforcement is completely replaced by the fibres as a result reducing cost, time and other logistical problems. Slab thickness can be reduced, which saves material while still retaining or even increasing flexural strength.

The behaviour of a centrally loaded SFRC slab is relatively linear up to initial cracking at the bottom face of the slab where they have higher tensile stresses. After cracking the response then differs slightly from linearity and the slab remains to carry load till the cracks have extended to the edges and form a failure mechanism. Substantial indentation occurs in the load introduction zone, while the corners of the slab are lifted up. The entire loss of load carrying capacity occurs by punching shear (Bischoff, 2003). Based on the cracking progress, Falkner and Teutsch (1993) introduced three different behavioural regions. Referring to Figure 7, these three regions are:

- (a) Region I: represents the initial un-cracked behaviour of the slab.
- (b) Region II: is governed by the formation of small radial cracks in the central area where the load is applied.

(c) Region III: represents the behaviour when the crack spread in the slab until collapse.

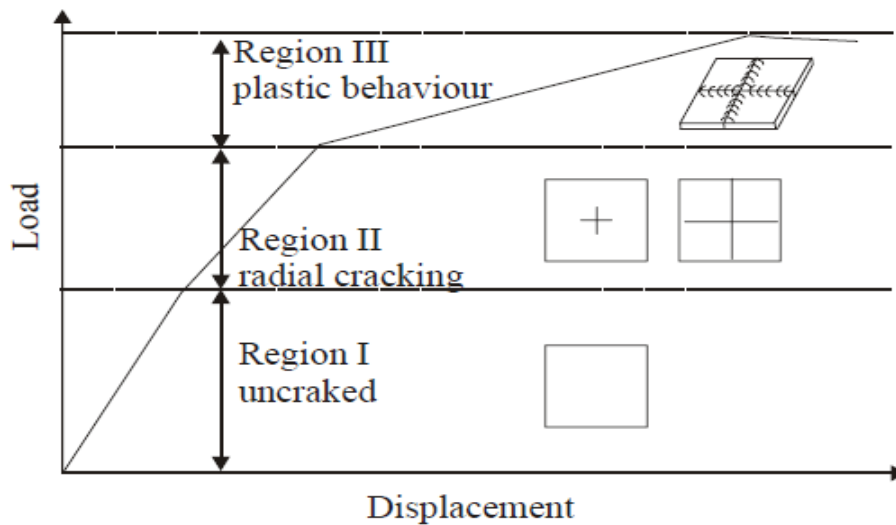

Figure 7. Typical load displacement response of SFRC ground slab (Falkner and Teutsch, 1993)

Considerable energy is required for the crack to propagate to the surface and extend to the edges. It is therefore necessary to consider the post-cracking behaviour when designing SFRC ground slabs. Failure of ground slabs is normally based on serviceability issues, which will affect the slab behaviour before cracking occurs and the slab does not meet the serviceability conditions when it cracks, though in service ground slabs normally crack without total disruption of service. Coetze and Van der walt (1990) stated that structural failure occurs when a slab is cracked and the crack has developed through the full depth along the sides of the slab.

## 2.7. Behaviour of materials under blast load

Over the past decade, the private sector has been developing standards for blast resistance design, using the military's parameters for guidance. Through testing done by the U.S. Army Corps of Engineers and private associations, engineers and researchers have studied the behaviour of blasts so that structural members can be adequately designed for blast events. Since blast loading is an extreme loading event, reasonable assumptions (such as large deformations and strategic failures) are required to maintain an economical design (Agnew, et al, 2007). Reinforced concrete is a kind of material that can meet the demands of blast resistant design because of its large mass and flexibility in detailing (Galinat, 2007).

Blast is a rapid release of energy taking the form of sound, shock-wave, heat and light. “The shock wave contains of extremely compressed air that wave reproduces off the ground surface to produce a hemispherical propagation of the wave that travels outward from the source at supersonic velocities” (Hinman, 2003). The shockwave of a blast can reflect off a surface with an amplification factor up to 13, compared to an acoustical wave, which able to reflect with an amplification factor up to 2. The amplification factor is influenced by the distance the shockwave travels before reflection and by the angle of incidence.

Another consideration in designing structural members for blast resistant design is load reversals. Late into the shockwave’s phase, the pressure becomes negative, creating a suction force. A graph of this response is shown below in Figure 8, where the blue dotted line indicates initial wave pressures and the red solid line indicates reflected wave pressures. Clearly, the reflected pressures are stronger than the initial pressures, as mentioned previously. Immediately following the suction force, surfaces experience a drag pressure as air rushes in bringing flying debris. “In an exterior explosion, a small part of the energy is also informed to the ground, making a crater and generating a ground shock wave parallel to a high-intensity, short-duration earthquake.” (Hinman, 2003) The extent of damage caused by a blast is determined by two factors: (1) explosive size measured in pounds of TNT and (2) distance between explosive and affected structural member.

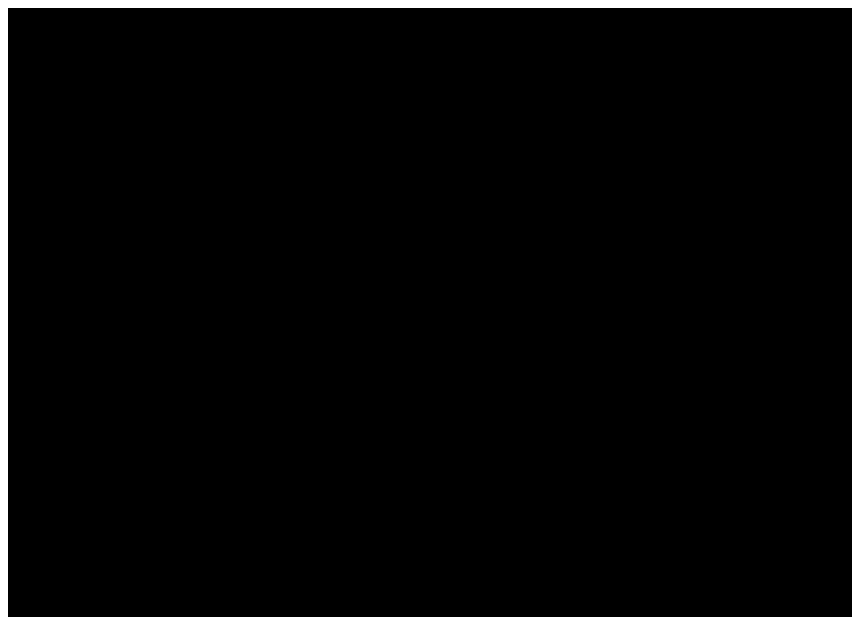

Figure 8. Air-blast pressure response over time (Hinman, 2003)

Reinforced concrete is the most mutual material for blast resistant design, due to its availability, relatively low cost, mass, and flexibility of detailing. (Laneet al. 2002) However, to understand the advantages of adding fibre to reinforced concrete, structural engineers first need to understand the advantages of using conventional reinforced concrete without fibres.

## **2.8. Blast loading**

Yusof et al. (2010) conducted a research about normal strength steel fibre reinforced concrete subjected to explosive loading. They have compared the behaviour of normal strength steel fibre reinforced concrete panels (SFRC) and plain reinforced concrete subjected to explosive loading.

The experiments were performed by the Blast Research Unit Faculty of Engineering of the Universiti Pertahanan Nasional Malaysia. They have used 8 reinforced concrete panels which has the size of 600mm×600mm×100mm. They have used hooked end steel fibre in this study and the steel fibre reinforced concrete panels combined three different volume fractions of 0.5%, 1.0%, and 1.5%. The panels were subjected to explosive loading produced by the explosion of 1kg of explosive charge situated at a 0.6m standoff distance. The research outcomes showed that by increasing the amount of steel fibres will affect the blast resistance of a concrete structure. The best experimental result in this search was achieved by using the volume of 1.5 % of steel fibre under explosive loading followed by concrete using 1.0% fibres. However the result showed that normal reinforced concrete and concrete containing fibre volume of 0.5% in the explosive loading are not as effective in resistance.

Yusof et al. (2010) studied the measurement of filed blast testing data using high speed data acquisition system for steel fibre reinforced concrete. In this research a field blast test was showed by the Blast Research Unit of Universiti Pertahanan Nasional Malaysia to examine the behaviour of steel fibre reinforced concrete panel subjected to air blast loading. The steel fibre reinforced concrete panels were subjected to air blast loading using plastic explosive (PE4) weighing 1kg at standoff distance of 0.3 meter. By using the high speed data acquisition system the factors



measured were free field blast pressure, air blast pressure and also acceleration of the slab.

The concrete test panels used for this study were Steel Fibre Reinforced Concrete Panel (SFRC) and Normal Reinforced Concrete (NRC) and panels were reinforced on both compression and tension. The bottom face of the slab was reinforced with 10 mm diameter steel at 200 mm centre to centre distance in both ways. The panels had a thickness of 150 mm and the dimension was 600× 600 mm. The SFRC mix combined 1.5 % of hooked-end steel fibres which used mild carbon steel.

They have used high speed data acquisition system which include, blast pressure probes, pressure sensor, software, cables and software accelerometer which are attached to the test specimen to measure the parameters. In this investigation high speed data acquisition system with sampling rate up to 2MHz and eight hardware-timed digital I/O lines were used to measure the structural reaction towards blast loading. Furthermore, the sensors are also selected specifically to make sure that they are capable of responding and delivering signals in the range of microseconds. The instrumentation and data acquisition system were situated inside a protected concrete building 40m far from the blast testing place (Figure 9).

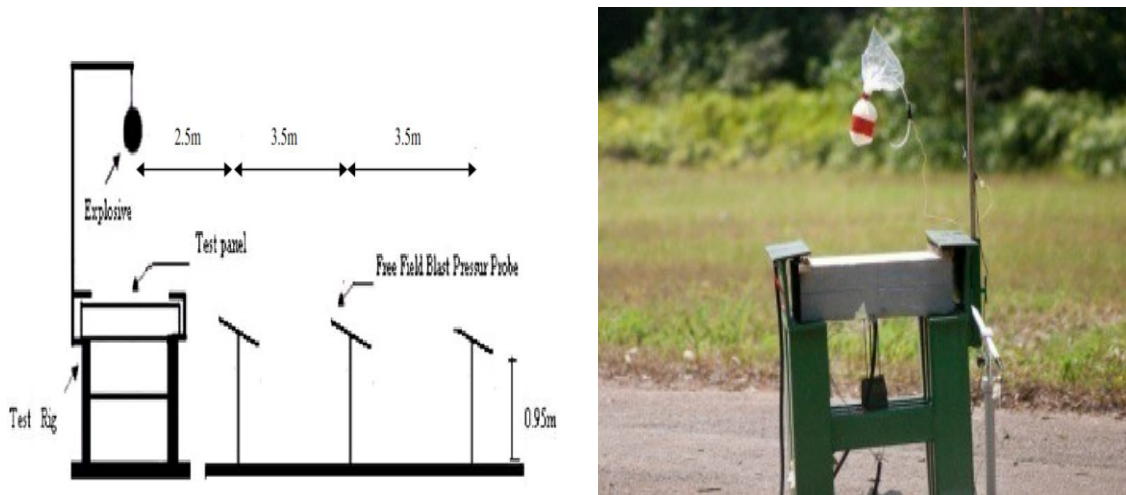

Figure 9. Free field blast pressure probe set up arrangement and field blast test set up

The outcome of this study presented the acceleration of the NRC is  $7600\text{m/s}^2$  while SFRC recorded  $5100\text{m/s}^2$ . The acceleration rate obtained has a connection with the failure pattern of the specimen. Acceleration rate signifies the ductility of the test

structure. Higher vibration methods can be related with larger shear force and lower ductility. Hence the acceleration test outcome indication of the low resistance of the NRC to blast loading.

### **2.9. Steel fibre reinforced concrete slab under impact loading**

The use of FRC in the marine community is based on the properties of impact resistance and crack control. Impact resistance is needed in jetties, piers and any place subjected to wear and tear from waves and water borne objects. The main need for FRC in marine structures is for its ability to control cracks and thereby reducing the possibility of corrosion in the main steel reinforcement.

Mahalingam et al. (2010) studied SIFCON slab panels under impact loading. RCC, PCC and FRC slab specimens further more comparison purposes for this study tested and cast under impact loading. An in-house manufactured impact testing machine was used in this research to carry out the impact test. The impact test machine has been fabricated and planned in accordance with the drop weight test, conducted by dropping an iron ball of diameter 100 mm and weight of 50N from a height of 450 mm.

This study showed fibre acts as an energy-absorption mechanism and by using more fibre volume in the concrete mix the ultimate impact strength in concrete will increase. The incidence of the first crack followed by few different cracks and the fibre bridging across these cracks performed not only as energy absorbing mechanism, but also as a load transfer mechanism

The maximum energy was absorbed by the SR slabs. At first crack stage, conventionally reinforced SIFCON slabs with 8%, 10% and 12% fibres had the energy-absorption capacity 4125%, 8350% and 28066% higher, respectively, when compared to SIFCON slabs with no conventional reinforcement. The least damage was attributed to the SR slab with 12% fibre volume in comparison to slabs with fibre volume of 8% and 10%. In contrast, the PCC slabs were broken into pieces under impact. (See Figure 10)

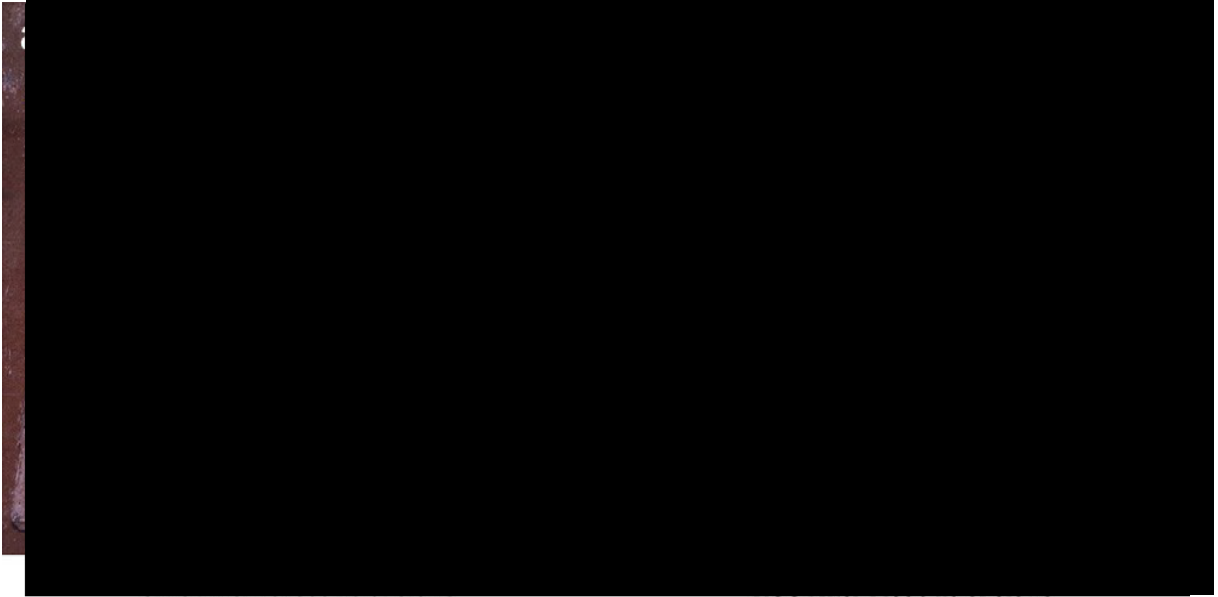

Figure 10. Experimental results (Mahalingam et al. 2010)

Knight et al. (2012) studied the response of plates under drop weight impact loading, their results from their investigation on the plates showed that plates that showed relatively low impact resistance at first cracking, are weak in impact resistance at failure. The random distribution of steel fibres in concrete resulted in resistance to expansion and propagation of cracks in the post cracking stage of concrete.

Madheswaran et al. (2014) studied the behaviour of reinforced geopolymer concrete slab under frequent low velocity impact loading. They have illuminated the experimental and numerical studies on the performance of reinforced GPC slabs under repeated impact loading concrete made out of this binder system have a number of advantages related to conventional Ordinary Portland Cement Concretes (OPCCs). Significant studies have been done on the impact behaviour of reinforced concrete structural elements though alike studies have not been stated on GPCs. The objective of this research was to gain the impact behaviour of reinforced GPC slabs with or without steel fibres and compare with that of OPCC slabs. The general sizes of the GPC slab were  $1 \times 1$  m, through 60 mm thickness and the test set up prepared for this experiment is shown in Figure 11. Furthermore Finite element modelling of slab was carried out by using ANSYS software. The measured impact load time history is used to excite the structure. The Solid 65 element and link 8 elements were used to model the concrete slab and Reinforcement correspondingly.

Displacement boundary conditions are applied at the supports. Transient dynamic analysis was used to get the terms of deflection time histories. The peak acceleration of analytical presented a pattern alike to that found from experimental outcomes. The failure crack pattern of steel fibre reinforced slabs predicted and plain concrete by finite element analyses are compared with experimental outcomes.



Figure 11. Test set up (Madheswaran et al., 2014)

The highest acceleration and at a specified number of drops, for a given height of drop was experienced by the OPCC slabs. While GPC slabs had relatively less acceleration for both panels of plain and fibre reinforced. The acceleration for fibre reinforced slabs was lower in comparison to the unreinforced panels, which could be accredited Figure 11. Experimental set-up for impact test (Madheswaran et al. 2014) the low elastic modulus which was reflected by reduced peak of the load pulse. In this research it was found that the measured peak acceleration and peak impact load increases as the height of drop is increased, while the contact duration of pulse decreases and it depends on the material properties and the stiffness of the slab. The pattern of the load time variation under repeated impact loading can be represented in a triangular pattern. Observing the slabs at both the cracking and failure stages revealed that for GPC panel relatively higher energy was absorbed compared to OPCC. The failure mode of the plain OPCC and GPC panels was in a perforation manner. However, scabbing failure was observed for fibre reinforced panels. When the impact loading is being repeated with low energy a progressive degradation of stiffness occurs. The FE analysis results on the peak deflection profiles showed a comparable pattern in agreement with experimental results. It is stated that since the fibre mixes have less mass participating in vibration, therefore the peak accelerations

are less. The deflection at mid-span increases as the number of drops increases. Their research highlighted that by appropriate design, GPC can be used for structural components subjected to low velocity under repeating impact loading. The incorporation of steel fibres, improved characteristics such as ductility, toughness, energy absorption characteristics, bond characteristics and impact resistance.

Hrynyk et al. (2014) studied the behaviour of steel fibre reinforced concrete slabs under impact load. (Figure 12) In this study seven intermediate-scale slabs were constructed and tested to failure under sequential drop-weight impacts. The slabs contained longitudinal reinforcing bars and were constructed with steel fibre contents ranging from zero (that is, conventional reinforced concrete) to 1.5% by volume of concrete. The data from the testing program were used to further assess the performance of steel fibre reinforced concretes in impact-resistant applications and to provide a well-documented data set pertaining to a research area which is currently limited within the literature.



Figure 12. Experimental set-up for impact test (Hrynyk et al. 2014)

The slabs used were 1800 mm square and 130 mm thick, and were doubly reinforced with equal amounts of steel in the top and bottom mats of reinforcement. Steel fibres with end-hooked were used in this study. The FRC slabs exhibited superior performances under impact loading conditions when compared with no fibrous RC slabs. The addition of end-hooked steel fibres led to reduce crack spacing's and widths; mitigation of local damage mechanisms, such as mass penetration and concrete scabbing; also increased slab stiffness and capacity. The increased impact resistances, stiffness's, and displacement capacities of the R/FRC slabs tended to correlate with the steel fibre volume fractions provided. The slabs forming the experimental program were designed such that they would be governed by flexural failure modes under conventional static loading conditions; however, all but one of the slabs were controlled by punching shear failures under impact. Inertial force development, which was shown to result in dynamic loading conditions that differ from those encountered under static testing, is suggested to be the main contributor to the punching shear failure modes observed. Under high-mass, low-velocity impact loading conditions, the behaviours of the slabs were not exclusively governed by local failure mechanisms. Global deformations contributed to the impact responses of all slabs, and the influence of local damage development was found to be of less significance in the R/FRC slabs. As the slabs in this study were ultimately controlled by punching shear failures under impact, limited benefits were attained as a result of increasing the longitudinal reinforcement ratios of the RC slabs.

Doo Yeol Yoo (2009) investigated the effect of FRPS strengthening and steel fibres on the enhancement of impact resistance of concrete slabs. This research investigated the compressive and flexural behaviours under static loading conditions for normal strength concrete as well as steel fibre reinforced concrete (SFRC), including 30mm long end-hooked steel fibres in different volume fractions varying from 0.5-1.5%. The flexural strengthening effect of externally bonded FRP (Fibre Reinforced Polymer) sheets and steel fibres on one-way slabs was investigated in a high strain rate range conditions (i.e. impact tests) using a drop-weight impact testing machine. For this test prismatic specimens with dimension of 50mm×100mm×350mm were used. Two different unidirectional FRPs (AFRP and CFRP) were used to strengthen the longitudinal direction of the specimens. The maximum capacity of 800 Joules was used for the impact test. Load cell and speedometer were used and attached to

the top of the drop weight to measure the impact load and velocity respectively. A drop weight of 12.965 kg was dropped freely from the height of 1045 mm applying single impact load to the mid-span of the specimens. The average impact velocity of 4.5 m/s and 133(J) potential energy respectively were used. Figure 13 below shows the test set up.

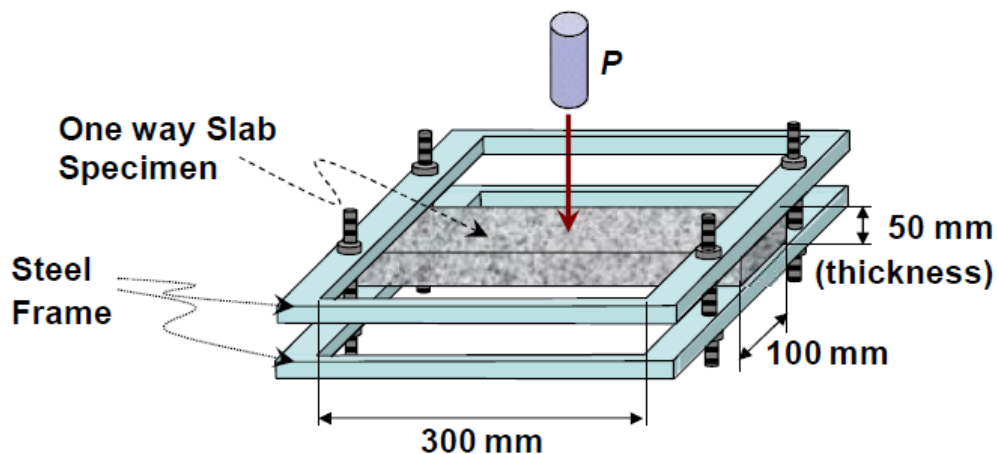

Figure 13. Test set up for one-way slab specimens (Doo Yeol Yoo, 2009)

The result of this study showed the compressive strength of concrete was reduced by the addition of steel fibres; also the flexural resistance of concrete is significantly improved by using FRP sheets and steel fibres for strengthening. In the case of the AS and CS specimens, the peak impact loads were about 19% higher than that of the NS specimen and the maximum deflections of the top of the specimen were decreased by about 34% due to the strengthening effect of AFRP and CFRP sheets. About 2.3~2.7 times higher impact energy was dissipated by strengthening with AFRP and CFRP sheets compared to the NS specimen. The maximum mid-span deflection and residual deflection of the CS specimen were about 1.3 times higher than those of the AS specimen. This indicates that AFRP sheet gives improved impact resistance performance with SFRC than CFRP sheet.

Elavenil et al. (2003) conducted a research study at Anna University Chennai of India about steel fibre reinforced concrete slabs to pendulum impact test. The plate

element is cast in 3 various moulds in which each one having fixed size of 600 mm × 600 mm but thickness variable from 20-30 mm. The diameter of the fibre is used for investigation on dynamic response of FRC plates for 0.7 mm and various type of aspect ratio (50, 75, and 100). A special arrangement was fabricated for applying impact loading on the slab through a pendulum weight of 18 kN. A vertical frame consisting of built up channels was welded on the toe making them a box section. The plate was mounted vertically inside the vertical frame which will enable applying the impact load through a pendulum which can be hug from three different inclination of 11°22°33° to the vertical. The edges of the slabs were fixed by means of Clamps. The plates were weighed before testing. A small iron chip was placed through casting the plate in order to pick up the impact effect. The pick-up leads were connected to an oscilloscope, amplifier and then finally to the industrial computer. The instrument set up is shown in Figure 14.



Figure 14. Test set-up for impact testing machine (Elavenil et al. 2003)

The result showed that the increase with the magnitude of 30% in the capacity of the slabs for steel fibre reinforced concrete plates fixed on two sides as compared to plates fixed on all four sides. The increase in aspect ratio of steel fibres shows a 30% higher frequency. The drop in the peak amplitude is gradual for steel fibre reinforced plate fixed on four sides. Smaller the thickness of plate, higher is the frequency. The variation in aspect ratio of steel fibre does not significantly change the behaviour.



In 2012, Elavenil and Knight also tested plates under drop weight impact. Dynamic behaviour of eighteen plates with varying thicknesses of 20, 25 and 30mm with three different steel fibre contents of 0.5, 0.75 and 1% were studied. The drop weight steel ball of 0.5 kg is used with a cylindrical drop weight of 4.5 kg connected to a tensile wire. As shown in Fig below. The support considered in this work for the plates are fixed and simply supported. The energy absorption and number of blows were increased drastically when the fibre content increased from 0.5% to 1%, also the higher aspect ratio (i.e. l/d) of fibres resulted in higher energy absorption, while this factor didn't affect the number of blows. Regarding the crack pattern, slabs with support for edges shows radiating cracks while plates with two sides fixed showed cracks parallel to the supports. (Figure 15)

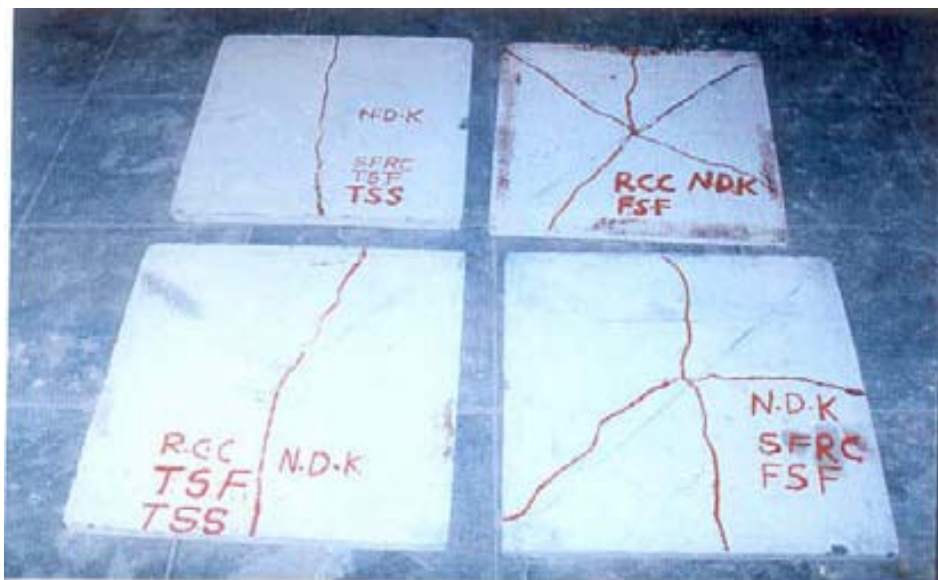

Figure 15. Cracking Pattern of Plates (Elavenil and Knight, 2012)

It was concluded that the effect of fibres were more pronounced for plates with thickness of 25 and 30 and randomly distributed steel fibres in concrete stopped the propagation of cracks in the post cracking stage of concrete hence less crack width were apparent.

Ong et al. (1999) focused on assessing the impact resistance of FRC slabs without conventional reinforcement, constructed using different types of fibres. The slabs were 1,000 mm square, 50 mm thick, and were subjected to repeated drop weight impacts using a hemispherical impactor with a mass of 43 kg, dropped from a height of 4 m. Line supports were provided along the four sides, and the slabs were

restrained vertically to prevent specimen uplift. Three fibre types were considered in the testing program: i) straight polyolefin fibres, ii) kuralon-cut polyvinyl alcohol (PVA) fibres, and iii) end-hooked steel fibres. The FRC slabs were constructed with fibre volume fractions,  $V_f$ , ranging from 0.5 % to 2.0 %. The properties of the fibres are summarized in Table (1).

*Table 1. Properties of fibres used in (Ong et al. 1999)*

Fibre Type	Shape	$l_f$ (mm)	$d_f$ (mm)	$f_{u,f}$ (MPa)	$E_f$ (MPa)
polyolefin	straight	50	0.63	275	2,650
polyvinyl alcohol	straight	12	0.20	900	29,000
Steel	end-hooked	30	0.50	1,275	200,000

The authors found that the steel fibre reinforced concrete slabs exhibited superior performance in terms of slab cracking characteristics, energy absorption, and resistance to shear plug formation when compared to the slabs reinforced with polyolefin and PVA fibres. The polyolefin fibres were reported to fail by a combination of fibre rupture and fibre pull-out, whereas the PVA and steel fibres were reported to fail by fibre pull-out only. The same testing frame and specimen geometry was used in this study; however, only end-hooked steel fibres were considered. The slabs were orthogonally reinforced in the plane of the specimens with conventional 6.5 mm diameter reinforcing bars, and the FRC was constructed using the same end-hooked steel fibres reported in the previously discussed program. Two drop-weight conditions were considered: i) a 20kg drop-weight with a hemispherical striking surface, dropped from a height of 1.5 m, and ii) a 20kg drop-weight with a flat striking surface, dropped from a height of 4.5m. One impact condition was used per slab, and impacts were repeated until failure occurred. From the experimental results, the authors found that the addition of steel fibres up to a volume fraction of 2.0% increased the number of impacts to failure by at least seven times. The slab midpoint deflection was found to decrease with increasing fibre volume, and additional conventional in-plane steel placed as compression reinforcement was also found to increase the impact resistance, particularly in the case of the lower-velocity hemispherical impactor. Overall, it was reported that the addition of the steel fibres greatly reduced local damage attributed to penetration and

concrete scabbing, reduced slab deflections, and increased the energy absorption, all of which resulted in significant increases in the impact capacities of the slabs.

Gopinath et al. (2014) investigated the impact behaviour of ultra-high strength concrete panels with 2% steel fibres, under low velocity impact. The panels had the size of 350 × 350 mm and thickness of 15 mm. the drop weight of 20 kg with 20 mm diameter was used at heights ranging from 100 mm to 300 mm. “the specimen was hinged over the supporting frame by means of fastening C-clamps over the corners which was followed by the ASTM D7136/D7136M – 07.” The results showed no patterns even when the drop weight ball was dropped for the second and the third time.

They also conducted an numerical analysis using ABAQUS using 8-node solid element (C3D8R), with three degrees of freedom for each node, to model both the steel impactor and ultra-high strength concrete (UHSC). The drop weight hammer made of steel was modelled as a rigid material as the deformation in the impactor is not expected solid elements. “Brittle cracking model is defined by giving the elasto–plastic behaviour of the material and the direct cracking failure strain is given as input under brittle failure option.” It was stated that this “model is most accurate in applications where the brittle behaviour dominates such that the assumption of the material is always linear elastic in compression is adequate.”

Farnam et al. (2008) studied the cylindrical fibre lightweight aggregate concrete samples with 150 mm diameter and 60 mm thickness under low velocity impact load. The fibres that were studied were Polypropylene (PP) fibre (at 0% and 0.4%) which was expected to enhance the lightweight aggregate concrete impact resistance. “4.54 kg compaction hammer with a 457 mm drop, 63.5 mm diameter hardened steel ball and a flat base plate” was used. From the results it is shown that the tensile failure was dominate in both plain concrete and 0.4% fibre reinforced specimens. And adding PP fibre to the plain concrete increases the impact strength approximately three times compared to the ordinary concrete specimens.

Also a finite element analysis of the specimens was conducted by LS-DYNA, and the contact between the projectile and the target and also between the target and the constraint is defined by contact-automatic-surface-to-surface option. The Von Misses stress contours and its distribution around the crack are analysed from the numerical

results. The results obtained from the finite element analysis also showed tensile failure was a dominant failure and they were fairly in good agreement with the experimental results, also it was stated that the soil-concrete material model was capable of simulating both plain concrete and fibre reinforced concretes.

## **2.10. Numerical literature**

Although the modelling technique requires wide exploration and discussion in order to simulate the impact mechanism on RC structures, recent studies have been focusing on this matter.

Mokhatar and Abdullah (2012) studied the ability of the general purpose finite element analysis to simulate and predict the impact behaviour of structural systems. ABAQUS was used and an experimental specimen was chosen to be simulated and analysed. For the 3D model, three dimensional continuum solid elements containing 8 nodes were used for the slab, while reinforcement bars were modelled using 2-node beam elements. In order to create a proper bond action between the rebars and the concrete the embedded technique was employed. Three different constitutive models for concrete were studied containing:

1. Drucker-Prager (DP) model,
2. Cap-Plasticity (CP) model, and meanwhile,
3. Concrete Damage Plasticity (CDP) model.

The first two models are regarded as ductile model while the CPD model is represented for brittle cracking model. The ductile behaviour (CP) could simulate the behaviour of dynamic loading in reinforced concrete structures close to the experiment. It was concluded that models that used ductile model showed more realistic results than the Brittle-Cracking model (i.e. CDP). The crack pattern at the bottom face of the slab was obtained by Brittle-Cracking model simulation and it corresponded well to the experimental one. Ranjan, et al. (2014) studied the local missile impact effects on reinforced concrete target and compared using available empirical formulations with those obtained using LS-DYNA numerical simulation. In this model the continuous surface cap model has been used for modelling concrete behaviour. A comparison between the numerical simulation results, and available

experimental results of slab impact tests showed that the numerical simulation is capable of capturing the experimental results.

Development of crack in concrete and the post failure behaviour is a major source of material non-linearity in reinforced concrete. The target was a square reinforced concrete slab with sides 1.2 m in length and 0.12 m thick. Eight node hexahedron solid elements were used for the concrete slab, with constant stress formulation using Gaussian quadrature using one-point volume integration. The continuous surface cap model (CSCM) was used to represent the concrete material. This model represents a recent development trend in continuum damage models for concrete. “The model considers effects of damage, strain rate and triaxial stress on the concrete strength. The CSCM strength model uses an ultimate failure surface which combines both shear failure and cap hardening. The strength model includes an ability to describe the pre-peak nonlinearity in concrete stress–strain curves involving low confinement levels.” The reinforcements were modelled using truss elements sharing the common nodes of the solid element with an assumption of full bond between truss element and concrete. To consider the strain rate effect in the analysis, Cowper–Symonds strain rate model (Jones, 1989) was adopted. “All the four bottom corners of the slab are restrained in the z vertical translational degree of freedom by applying constraints for four nodes at each corner.”

The result shows that the missile velocity is, probably, the main factor in defining the target damage. “The local and global behaviour of the concrete slab subjected to missile impact for all the three experimental tests could be predicted closely by the FE analyses using LS-DYNA.” Figure 16 shows the results of the analysis.

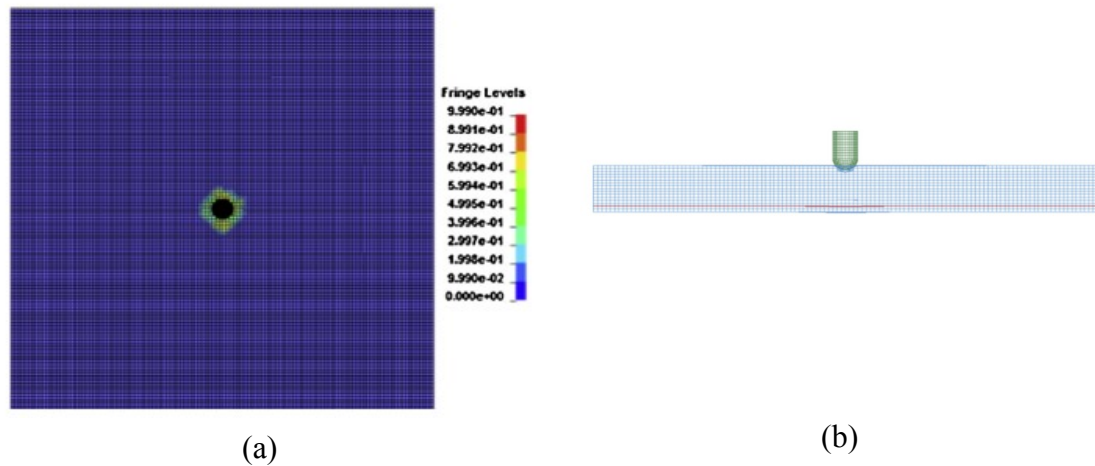

Figure 16. FE Results: (a) Damage fringe for bottom of slab, (b) deformed shape (Mokhatar and Abdullah, 2012)

Martin, O. (2010) in a EUR report, presented a numerical research on applying different constitutive models for concrete in ABAQUS/Explicit for missile impact. Two different constitutive models available in ABAQUS/Explicit, namely the Brittle Cracking Model and the Concrete Damaged Plasticity Model, were used to explore their suitability and restrictions for missile impact analyses. “Standard linear solid elements (HEX8, ABAQUS elements C3D8/C3D8R, Lagrangian formulation) are used. The reinforcement of the concrete slab is modelled with truss elements.” The truss elements are coupled with the HEX elements of the concrete slab with the \*EMBEDDED ELEMENTS function of ABAQUS. According to this report for the cases that the overall material behaviour is dominated by tensile cracking the Brittle Cracking Model is used based on the assumption that the compressive behaviour of concrete is always linear elastic. Different low and high initial velocity values ranging from 75 m/s to 500 m/s were used.

In conclusion it was found that the Concrete Cracking Model cannot be a suitable constitutive model for modelling missile impacts on reinforced concrete slabs when solid 3D meshes were used.

Due to the absence of the failure criterion in the Concrete Damaged Plasticity Model large amounts of artificial energies can be built-up “during the analyses as a result of adding artificial stiffness’s to finite elements by the FE solver in order to avoid excessive compression and distortion of elements to zero volume.” It was stated that this is an obstacle for the hard missile with high initial velocities.

The Concrete Damaged Plasticity Model leads to reasonable and sound results in terms of strains/stresses of the reinforced concrete slab for the case that deep penetration of the missile into the reinforced concrete slab is unlikely (soft missile). (Martin, 2010)

Sangai and May (2009) used LS-DYNA to analyse the ability of numerical methods and material models to predict the behaviour of RC slabs under low velocity drop weight impact load which is more relevant in civil engineering structures. A drop weight of 380kg with velocity up to 8.7 m/s was used. Square slabs of 760mm x 76mm and 2320mm x 150mm were modelled. Eight node hexahedron elements were used to discretise the slab and drop weight and to model the reinforcement bars beam elements were used. One-point gauss integration and viscous hourglass control were used. Supports were not modelled explicitly while the vertical and horizontal movement of the slab edges were restrained. Beam elements and solid elements share a common node.

Concrete Damage Rel.3 was used for the concrete. The impactor was modelled as rigid and a surface to surface contact was used between impactor and the slab. With 98.7 kg of drop weight the slab had no perforation and only local damage at the top and bottom and this was modelled satisfactorily with similar damage diameter. The damage concrete damage model also modelled the damage of the slab with a very good agreement with experimental results. Overall, it was concluded that finite element and the both material models are capable of simulating the impact behaviour of the reinforced concrete slab.

Yu (2012) analysed the impact behaviour of Ultra-High Performance Fibre Reinforced Concrete (UHPFRC) plates (300 x 300 x 50 mm), which has steel fibres to compensate for the brittle behaviour of the UHPC, under high velocity impact of deformable projectile using LS-DYNA. The elements used for both plate and projectile were the 8-node hexahedron solid element. The kinetic energy of the projectile decreased while the impact was happening which was thought to be attributed to the energy absorption capacity of the UHPFRC plate. It was concluded that the numerical model was capable of predicting the behaviour of the material. Moreover, UHPFRC can effectively reduce the scabbing proportions on the concrete plate and enhance the behaviour of the plate under impact.

### **2.10.1. Cracking models for concrete**

The classical assumption about crack growth is that it is an essentially brittle process in which strength perpendicular to crack drops to zero as soon as the crack has formed (Chen, 1982). For some materials this assumption is not fully correct as the tensile stress perpendicular to the crack does not drop to zero right away but gradually (softens) as the crack opens. A major consequence of softening is that the material can neither be assumed to behave elastic perfectly plastic nor elastic perfectly brittle. Instead the behaviour can be dealt with using the concept of elastic softening formulation. Under the framework of finite element analysis of concrete structures, the cracking is primarily categorised into discrete and smeared approaches.

In the discrete crack approach, introduced by Ngo and Scordelis (1967), a crack is modelled as a geometrical discontinuity. The material behaves elastically until crack initiation, i.e. when maximum principle stress exceeds the limiting tension stress of the material. At a particular load beyond the cracking point the inter-element boundary nodes, where the limiting stress is exceeded, are realised. Hence, the particular element is subject to the assumed tension softening stress- displacement relation. This procedure is repeated with every load increment until the energy is exhausted in a process zone and eventually failure occurs. The fracture process zone is assumed to have a negligible thickness. Fractured nodes affect the neighbouring elements, thus required modification of the element topology in the vicinity of the particular node. Several developments of the discrete crack models exist. In general simple discrete crack models use special interface elements. Which must either be placed initially in predefined planes in the model in anticipating of crack, or a re-meshing strategy is required for the elements in the vicinity of the crack.

### **2.11. Conclusion**

According to previous researches the mechanical properties of the concrete with steel fiber have been improved namely the flexural strength of the beam from 1.5 to 3 times. Previous research mainly considered different volume fractions ranging between 0.5% -1.5%. While 2.0% steel fiber is found to become common in the industry recently. The main research was conducted on straight fiber, twisted fibers, also some research on crimped and end hooked fibers. But no comprehensive and



complete test was done on the end hooked fiber to test all mechanical properties for the end hooked steel fiber. Therefore this study focused on end-hooked fiber which seemed to perform better and also considered the 2% steel fiber as well as the 0.5%-1.5% to be able to compare all contents of the fibers and make a good comparison.

Use of FRP sheets under plates improved the flexural strength and the peak impact load and using steel fiber in plates showed higher energy absorption of the plates under impact load. SFRC has been of interest to be used in the infrastructures in previous researches due to its bridging effect hence considered for extreme loads such as impact. The research in this area has mainly focused on plates and slab behaviour is fairly new. Especially the research is mainly considering the plain concrete for the impact analysis of the slabs. Also, the FE analyses of such problems are being developed to better simulate the behaviour of FRC material under such special loads. Therefore there is a need for further investigation on impact resistance of SFRC slab using FEM.

## **CHAPTER THREE**

### **Methodology**

The experimental study aims to understand the material behaviour of SFRC. To predict the effect of impact load on concrete slab different approaches such as experimental and numerical methods could be used. Experimental research gives a realistic insight to the problem and results, while numerical model is another direction of the research activities to study the behaviour of structural members in which with the aid of simulation tools the real behaviour can be represented under ideal condition. Experimental work could be impractical or expensive; however the significant development in the computer technology development in the recent years makes the numerical techniques more popular for obtaining detailed results. This provides researchers with the opportunity to extend the application of the numerical models to perform parametric studies by virtual experiments. On the other hand, it is important to validate the numerical results with an experiment.

It is worth mentioning that a numerical modelling of RC slabs that are loaded under impact loads is a concept that has not yet been accurately established. Furthermore, current codes are unable to suggest a clear and realistic approach for the design of slabs under impact load. However, a verified method for studying and predicting possible failure mode is a crucial requirement. For better numerical modelling extensive experimental results on material behaviour is required to be able to model the material as accurate as possible in the finite element software.

The material experiment will be conducted to give a sight into the real material behaviour of the SFRC and study its mechanical behaviour using the end-hooked SFRC and also make the results available to other researchers for future research works.

# CHAPTER FOUR

## Experimental Work

### 4.1. Material and mix design

Concrete is a composite material that its constituents contains cement, fine aggregate, coarse aggregate and water. The concrete mixture was prepared of the concrete includes mixing of fine aggregate, coarse aggregate and cement and then water is added to the mix. For each batch cylindrical specimens, cubes and beams were casted and tested to determine the compressive strength, split tensile strength and flexural strength of the concrete.

The end-hooked steel fibres are chosen for this research which are more common in the industry and perform better rather than other types (such as straight steel fibres) due to better anchorage with concrete. According to previous studies and recommendation of industrial companies such as Maccaferri Limited and Bekaert (Dramix), the volume fraction of these fibres will vary from 0.5 % to 2.0%. Table 4 below summarizes the properties of steel fibres to be used in this study.

Table 2. Steel fiber properties

Type of Fibre	Length (mm)	Diameter (mm)	Aspect ratio (L/D)	Tensile Strength (MPa)
Hooked end	33	0.55	60	1200

### 4.2. Concrete mix design

The plain concrete is designed for a target compressive strength of 35 MPa. For the SFRC the same proportions are used with different dosage of steel fibers. Table 5 below shows different concrete types casted for this study as well as the concrete mix design proportions for this experimental work. Portland cement type 42.5, sharp sand for fine aggregate, and shingle gravel aggregate with a maximum size of 10 mm were used. Figure 18 shows all materials used for the mix.

Table 3. Mix proportions of the concrete mixtures for 1m<sup>3</sup>

Mixture name	Cement (kg)	Water (L)	Aggregate		w/c	% Fiber*	Fiber (kg)
			Fine Aggregate (kg)	Coarse Aggregate (kg)			
				10 mm			
PC	375.0	167	696.0	1044.1	0.44	0	0
SFRC0.5	375.0	167	696.0	1044.1	0.44	0.5%	11.9
SFRC1.0	375.0	167	696.0	1044.1	0.44	1.0%	23.74
SFRC1.5	375.0	167	696.0	1044.1	0.44	1.5%	35.6
SFRC2.0	375.0	167	696.0	1044.1	0.44	2.0%	47.5

\* By wt. of concrete



Figure 17. Concrete Constituents

### 4.3. Mixing procedure

Coarse aggregates are first added to a concrete mixer (Figure 19.a). And then sand is added (Figure 19.b). When mixed uniformly the cement is added and let to be mixed with the rest of the constituents for about 3 minutes. When evenly mixed and consistent mixture of dry constituents is achieved (Figure 19.c), water is added gradually to the appropriate amount based on the designed w/c ratio to obtain a good workability. (Figure 19.d) In the case of steel fibre reinforced concrete the steel fibres are added (% by weight of concrete) before the addition of water into the mix (Figure 20) to allow for proper distribution of the fibres in the matrix.

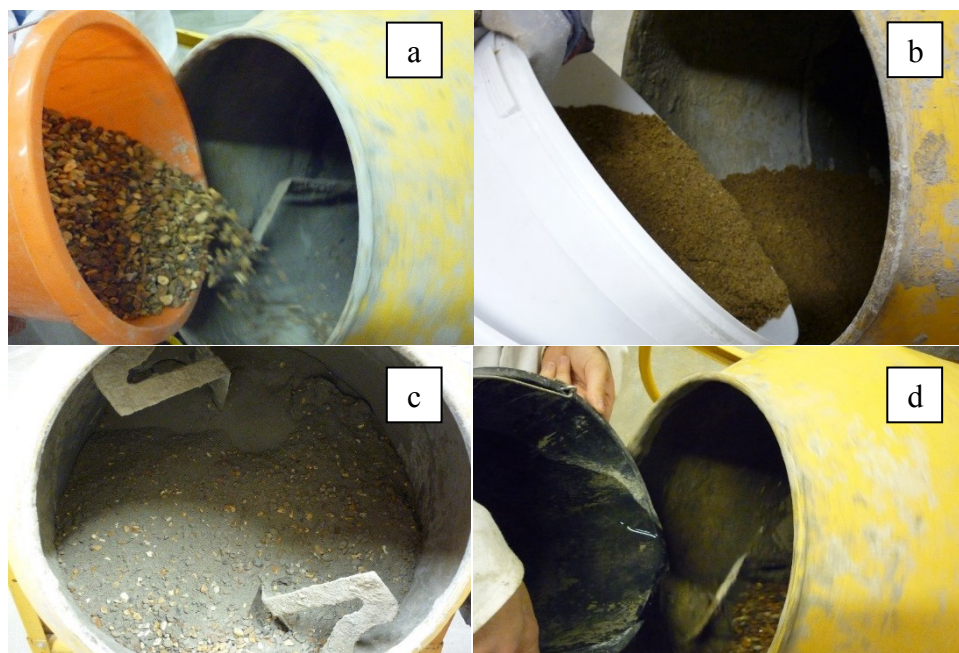

Figure 18. (a) Addition of coarse aggregate, (b) Addition of sand, (c) Dry constituents mixed uniformly, (d) Water added to the mixture



Figure 19. Adding steel fiber to the mix

After the mixing it was essential to measure the slump value. Slump value demonstrates the workability of the concrete. There are different types of slumps as shown below in Figure 20.

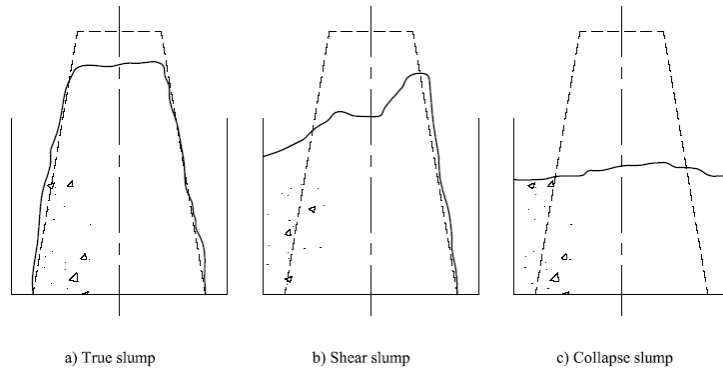

Figure 20. Forms of slump

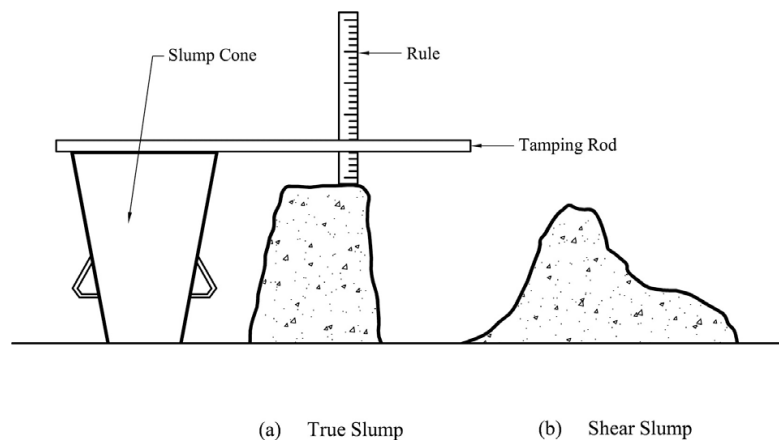

Figure 21. Measuring slump

To measure the slump, a slump cone is used on a plate and concrete is poured inside the cone. When  $\frac{1}{3}$  of the cone is filled the concrete is tamped with tamping rod 24 times. This is repeated when  $\frac{2}{3}$  of the cone is filled. When the cone is filled with concrete the top surface is made to be smooth. Then the cone was lifted within 5 seconds and the distance from the top of the concrete to the top of the cone is the slump value. Figure 21 shows the method of measuring the slump and Figure 22 shows the measurement after the mixing.



Figure 22. Slump measurement after mixing



Figure 23. Covering inside the moulds with specific oil

Figure 22 shows that with the same water to cement ratio for all mixes the slump value is changing. With the addition of fibers the consistency of the mix is influenced hence the slump value decreases. The surface area of the fiber is a factor to consider. In addition to the coarse aggregate the sand and cement must also coat around the fibers. If the fraction of sand and cement is insufficient, then the effect on the slump and workability will be more, meaning that with the same amount of sand and cement ratio, increasing the fiber volume will require more sand and cement to coat the fibers and the consistency of the mix is less as well as higher air content in the mix. Overall, the workability of SFRC was less than plain concrete due to these reasons. This effect was more visible with the addition of higher percentage of fibers. After the preparation of the concrete, the moulds were covered with specific oil as shown in Figure 24 and concrete was poured in the moulds and vibrated on a shaking table for about 2 minutes (Figure 24. (a)) until the excessive air is removed from the concrete. Figure 25.b shows moulds with concrete after vibration.





Figure 24. (a) sample moulds on shaking table, (b) Concrete moulds

The moulds were then covered by a wet cloth as shown in Figure 25. After 24 hours the concrete specimen was de-moulded and the specimens were labelled with the type of concrete and put in water tank in the curing room with room temperature to be cured until the test date. (Figure 26)



Figure 25. Covering of the specimen after casting with wet cloth



Figure 26. Concrete specimens cured in water tank

#### 4.4. Test set up

The tests for monitoring the performance of steel fiber reinforced concrete were conducted using ADVANTEST 9 laboratory system, with Servo-hydraulic control console at City University London. The tests are categorised as below:

- Cube Compression Test:
  - 21 Day
  - 28 Day
- Cylinder Compression Test
- Split Tensile Test
- Flexural Test

##### 4.4.1. Cube Compression Test

For each batch of concrete, numbers of cubes were casted and tested under uniaxial compression load. (Figure 27) This test was carried out at two different ages of the concrete; 21 days and 28 days. As recommended in BS EN 12390-3:2002 for conducting cube compression tests a constant rate of loading within the range of 0.2 MPa/s (N/mm<sup>2</sup> s) to 1.0 MPa/s (N/mm<sup>2</sup> s) is recommended. Therefore for this test a load rate of 4000 N/s (i.e. 0.4 MPa/s) is used for all specimens at constant rate throughout the test until the specimen fails.



Figure 27. Cube compression test set up

- **21 Day Test Results**

The results of the cube compression tests are presented in Table 4 showing the results after 21 days of casting for all concrete types. Figure 28 also compares the results showing the progress trend of the results.

Table 4. Cube Test Results

Specimen	Sample No.	Specimen	Max Load (kN)	Stress (MPa)	Average Stress
PC	1	Cube 100×100×100 mm	375.1	37.5	35.4
	2		364.2	36.4	
	3		323.1	32.3	
SFRC 0.5%	1		407.4	40.7	37.8
	2		366.4	36.6	
	3		369.1	36.9	
	4		371.0	37.1	
SFRC 1.0%	1		439	43.9	43.6
	2		276	27.6*	
	3		432.9	43.3	
	4		436.5	43.6	
SFRC 1.5%	1		451.8	45.2	43.2
	2		421.9	42.2	
	3		420.5	42.05	
SFRC 2.0%	1		469.9	47.0	47.5
	2		465.6	46.6	
	3	405.9	40.6*		
	4	474.8	47.5		

\* This result is disregarded

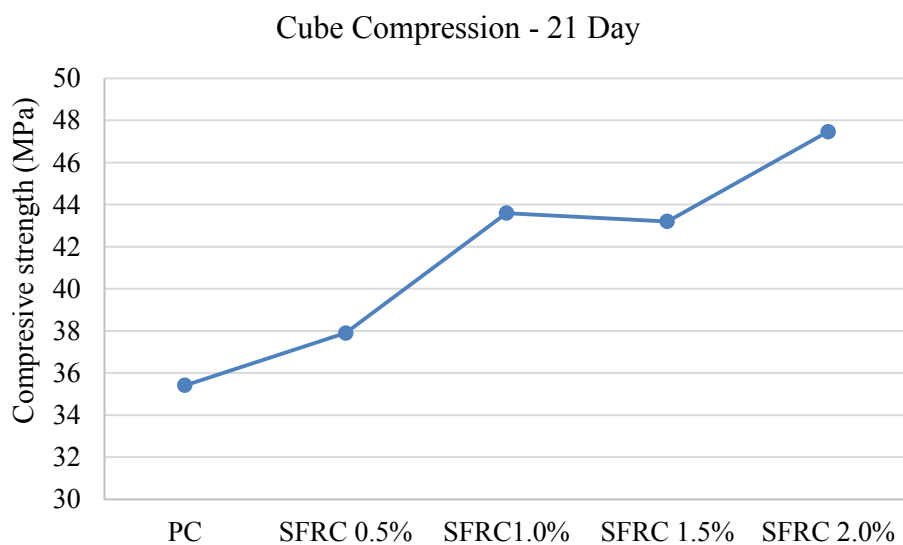

Figure 28. Cube Compression Test Results – 21 Day

It can be seen that the strength has an increasing trend with the increase of volume fraction of fibers and the increase in strength from SFRC0.5% to SFRC1.0% is noticeable while increasing 0.5% volume of fibers from 1.0% to 1.5% doesn't have significant effect on the compression strength. This could be attributed to the air content of the concrete, which previous researchers believe that the air content increases with the increase of steel fiber volume fraction, hence decreasing the compressive strength. However the addition of 2% of steel fibers in the plain concrete increased the compressive strength of cubes at 21 day age by 25.5% meaning that the air content of the concrete in this mixture is not affected by the fibers and it performs better than other mixes. However, the effect of more fibers is more pronounced in the damage that is visible on the cubes as shown in pictures below.

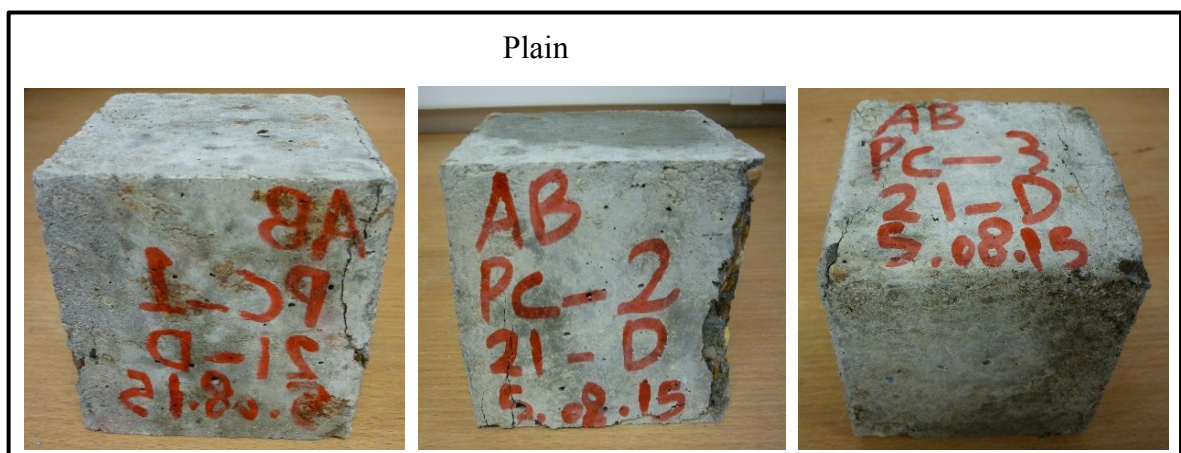
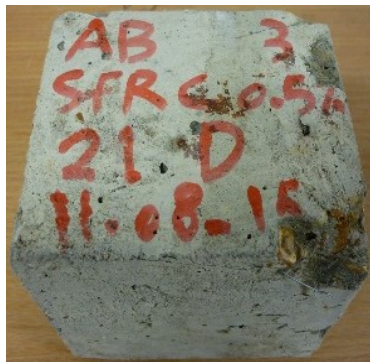
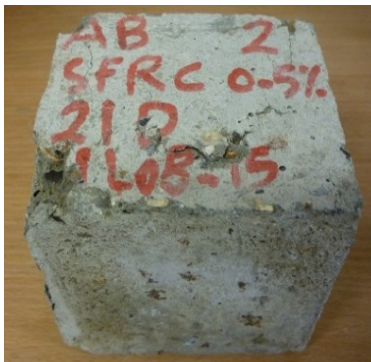
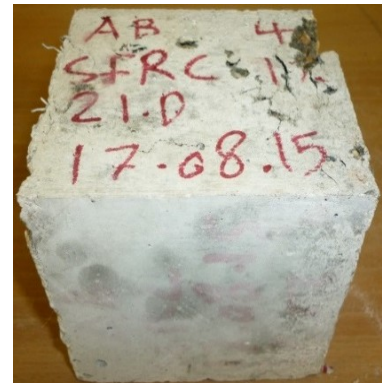
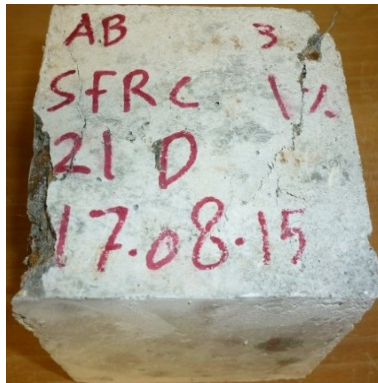
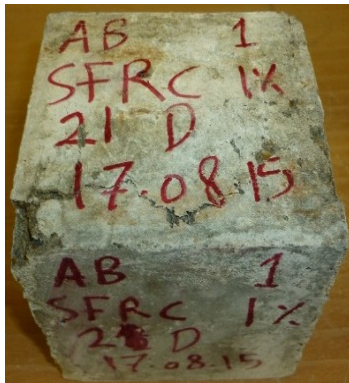

Figure 29. Cube Compression Specimen Results (21 Day)

SFRC 0.5%



SFRC 1.0%



SFRC 1.5%

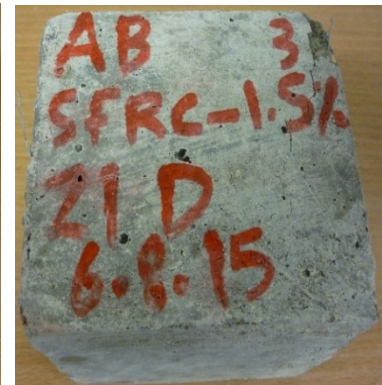
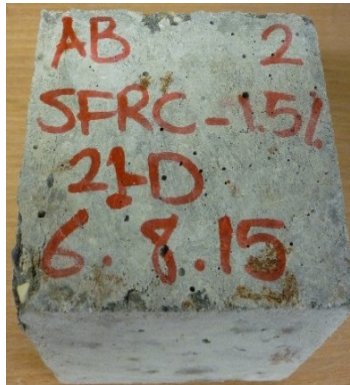

SFRC 2.0%



Figure 30. Cube Compression Specimen Results (21 Day)-continued

- **28 Day Test Results**

The increasing path for the strength is also visible for concrete at 28 days (Figure 31). Compared to the strength of concrete at 21 days the concrete at its full strength has higher strength by an average of 1.8%.

*Table 5. Cube Compression Test Results for 28 Days*

Specimen	Sample No.	Specimen	Max Load (kN)	Stress (MPa)	Average Stress
PC	1	Cube 100×100× 100 mm	377.3	37.73	37.3
	2		373.5	37.35	
	3		366.9	36.69	
SFRC0.5 %	1		373.4	37.3	39.8
	2		452.3	45.2	
	3		413.5	41.3	
	4		354.1	35.4	
SFRC1.0 %	1		441.2	44.12	44.4
	2		459.7	45.97	
	3		430.1	43.01	
	4		445.7	44.57	
SFRC1.5 %	1		374.2	46.1	45.1
	2		383.9	45.2	
	3		395.9	44.1	
SFRC2.0 %	1		496.4	49.6	49.2
	2		487.2	48.7	
	3	494.5	49.4		
	4	489.9	49.0		

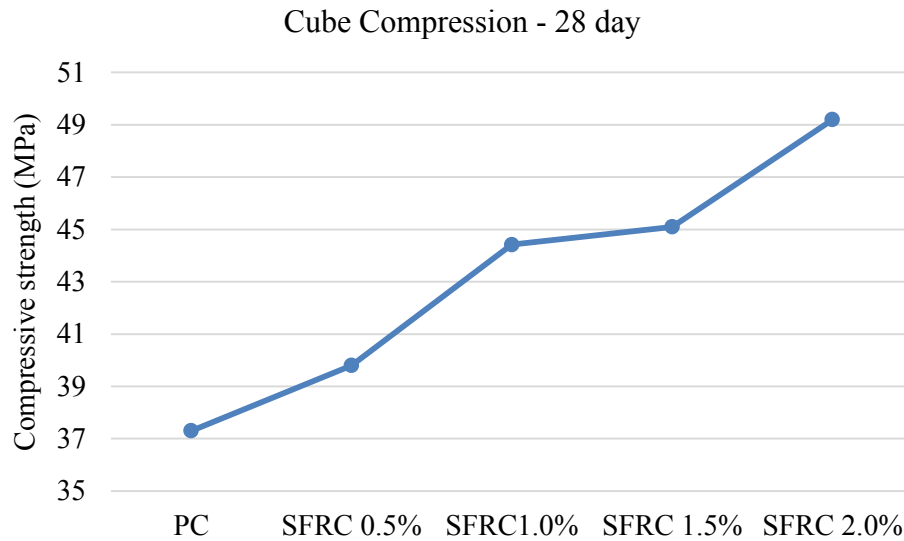

Figure 31. Cube Compression Test Results – 21 Day

Figure 32 reveals how the concrete damage is less severe and the presence of the fibers in more amounts has been more effective. The performance of samples with 1%, 1.5% and 2% are all as equally as good and have been effective although 2% fiber showed the least damage.

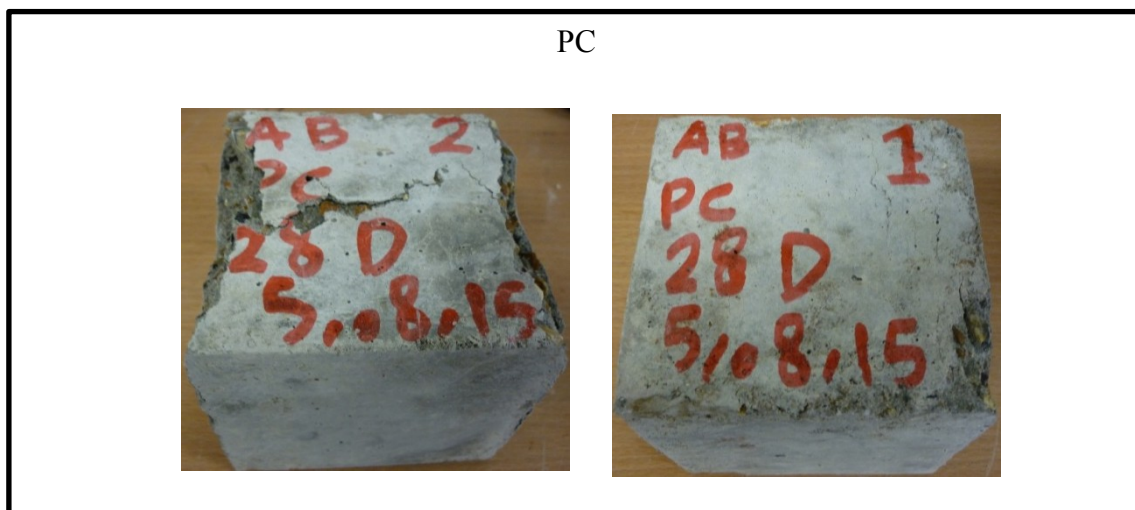
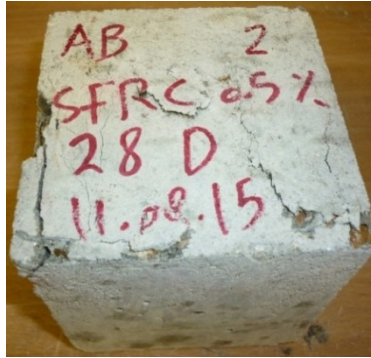
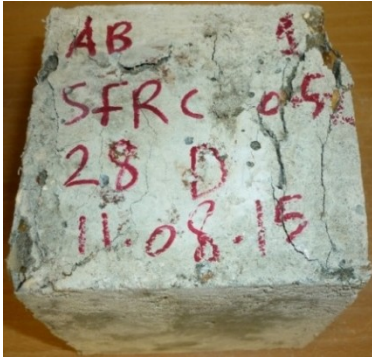

Figure 32. Cube Compression Specimen Results (28 Day)



SFRC 0.5%



SFRC 1.0%

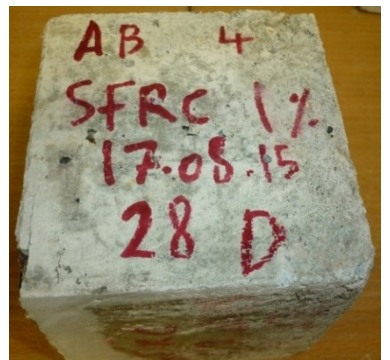
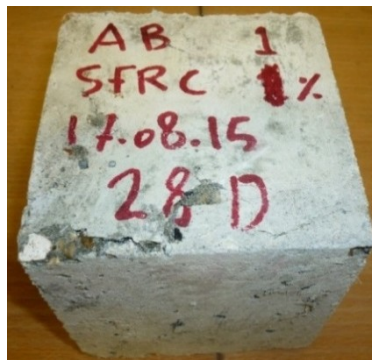

SFRC 1.5%

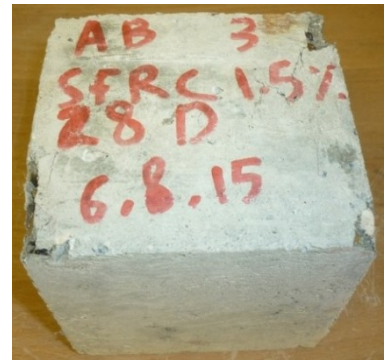
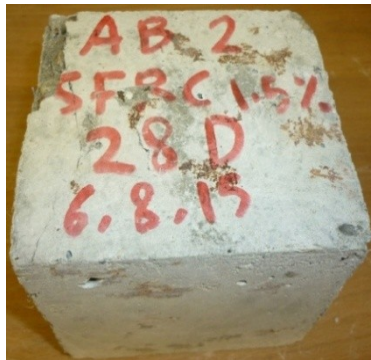
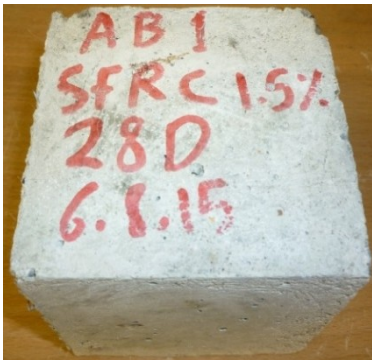

SFRC 2.0%

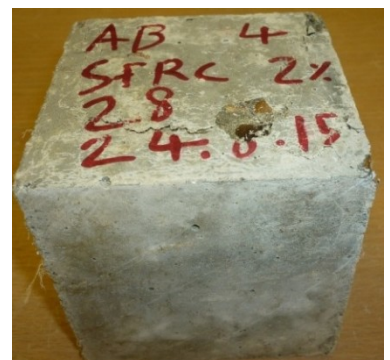
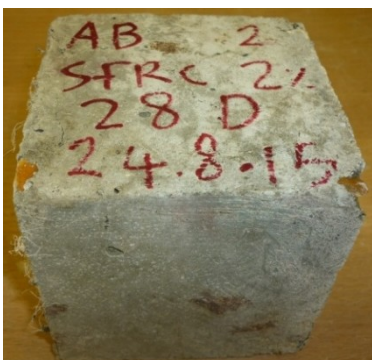

Figure 33. Cube Compression Specimen Results (28 Day)-continued

#### 4.4.2. Cylinder Compression Test

Cylindrical Compression tests are conducted in accordance with BS EN 12390-3:2002. The load was applied in displacement control manner to be able to monitor the strain in the concrete as well as the post peak behaviour. Although this was the aim but some samples after having failure cracks the test was terminated by the machine and the full behaviour could not be captured. The displacement was controlled through displacement transducers (as shown in Figure 33). Three displacement transducers were attached to each cylinder in equal angular distances of 120°. The transducer was hammered into concrete and tightened with an elastic band around all three transducers. The displacement control rate that was used was 1µm/s. Figure 33 shows the set up for this test.

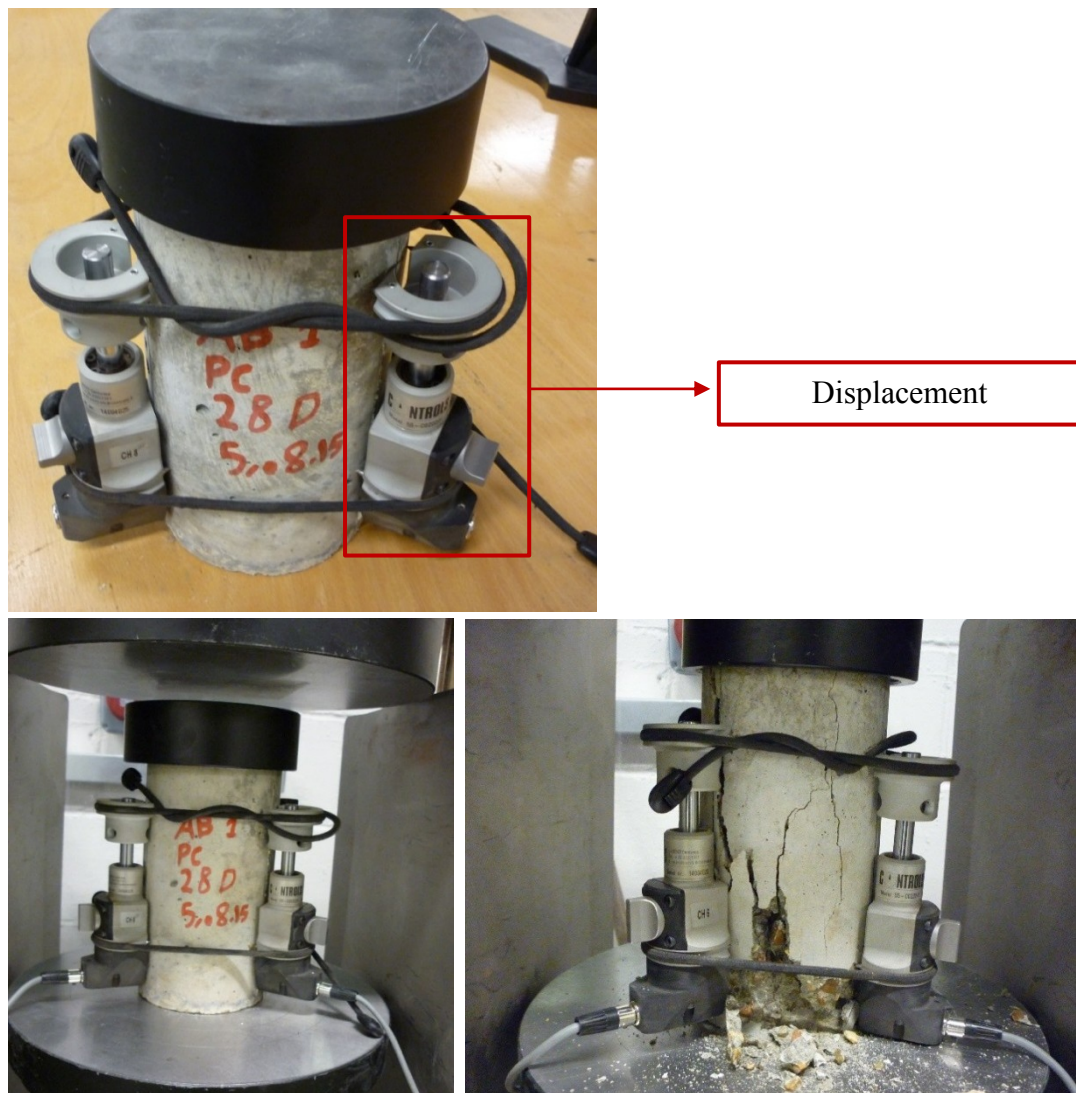

Figure 34. Cylindrical Compression Test Set up.

The results of this compression test for all concrete types is summarised in Table 6.

Table 6. Cylinder Compression Test Results

Specimen	Sample No.	Specimen	Max Load (kN)	Stress (MPa)	Average Stress
PC	1	Cylinder H200×Ø100 mm	269.9	34.37	35.23
	2		264	33.61	
	3		292.9	37.29	
	4		280.0	35.66	
SFRC 0.5%	1		282.1	35.92	36.34
	2		286.68	36.50	
	3		284.85	36.27	
	4		287.93	36.66	
SFRC 1.0%	1		262.9	33.47	37.39
	2		317.3	40.4	
	3		273.9	34.87	
	4		320.4	40.8	
SFRC 1.5%	1		298.4	37.99	37.64
	2		293.9	37.42	
	3		299.3	38.11	
	4		296.6	37.76	
	5	289.9	36.91		
SFRC 2.0%	1	301.96	38.45	38.10	
	2	298.24	37.97		
	3	296.79	37.79		
	4	299.97	38.19		

\* This result is disregarded

The compressive strength of the fibers is increased by 8% when 2% of fibers is used (i.e. 10 kg/m<sup>3</sup>) while in the results of Sukumar and John (2014) the compressive strength increased by 3.5 % with the addition of 20 kg/m<sup>3</sup> of end hooked steel fiber with aspect ratio of 80. Also Kothadia and Mishra (2015) observed that compressive strength increases from 8% to 26% with addition of hooked end steel fibres by 2.0%, 2.5% and 3.0% by cement weight. The results of the 2.0% fiber addition is identical to that of this studies experiment with 2.0% of steel fibers. However, the studies of Wafa back in 1990 showed that the end hooked fiber addition had no effect on the

compressive strength values. But, the brittle mode of failure associated with plain concrete was transformed into a more ductile one with the increased addition of fibers similar to the result of this research where the specimens showed crack control and better post peak behaviour with the addition of 2.0% fibers.

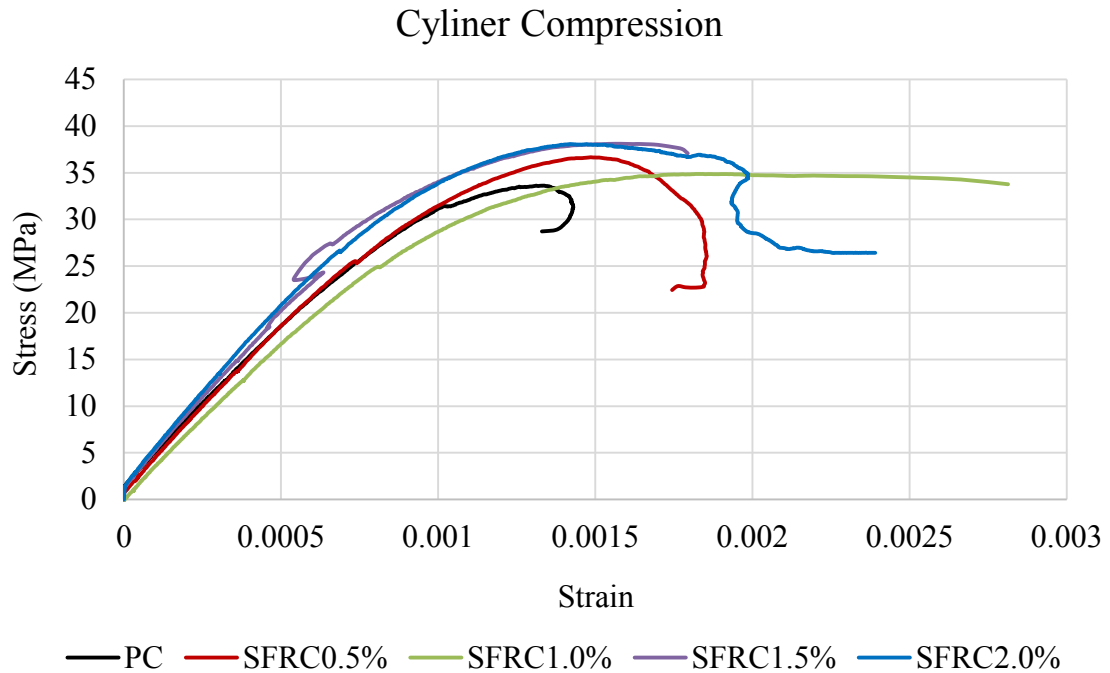

Figure 35. Cylinder Compression Results

The strain is calculated based on the average displacement of the three transducers and the stress-strain graph for each concrete type is plotted in Figure 34.

As can be seen from the graph the use of steel fiber affects the post peak behaviour of the concrete. The plain concrete does not show gradual decrease after it reaches the maximum strength, while, specimen with fibers demonstrate gradual decrease in strength after post-peak. This is especially evident in SFRC1.0%-2.0%. The behaviour of SFRC with 2.0% and 1.5% is very close regarding the stiffness of the concrete and strength. SFRC2.0% which has the highest quantity of the steel fibers is the stiffest with higher compressive modulus of elasticity. While the effect of fibers on the maximum strength is not very significant, but the damage pattern in the specimens demonstrates the effect of fibers better and how higher fiber volume fraction improved the level of damage in concrete.

Below the damage in all specimens are shown and compared.

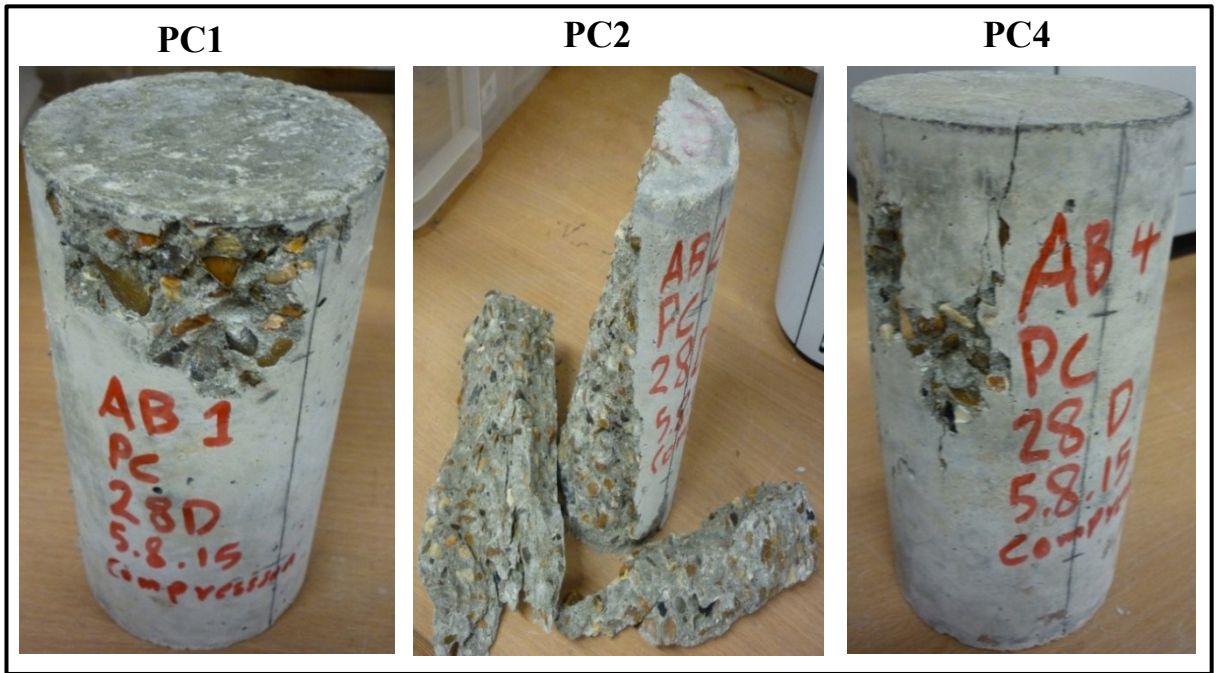

Figure 36. Plain concrete sample after the test

As can be seen in the Figure above the damage for plain concrete specially PC2 is more severe which also had the least strength amongst other samples. This sample is totally damaged and crushed into pieces. When 0.5% of fibers is added to the mix the concrete cylinders show cracks through the specimen as well as spalling of the concrete. Sample PC1 and SFRC0.5-3 has similar damage of spalling, in which both have shown spalling close to the end of the cylinder, however with less depth in SFRC sample.

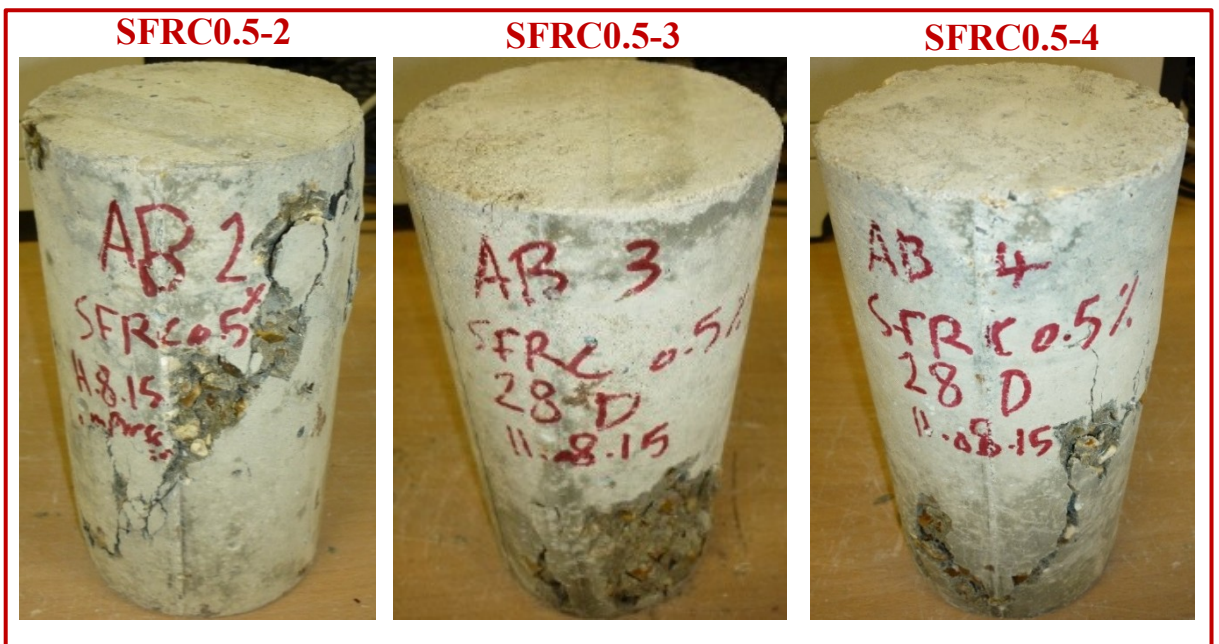

Figure 37. SFRC0.5 sample after the test

For samples with 1.0%, 1.5% and 2.0% these cracks do not occur and the damage is in the form of concrete spalling from the sides mainly closer to the top or bottom as such in Figures.

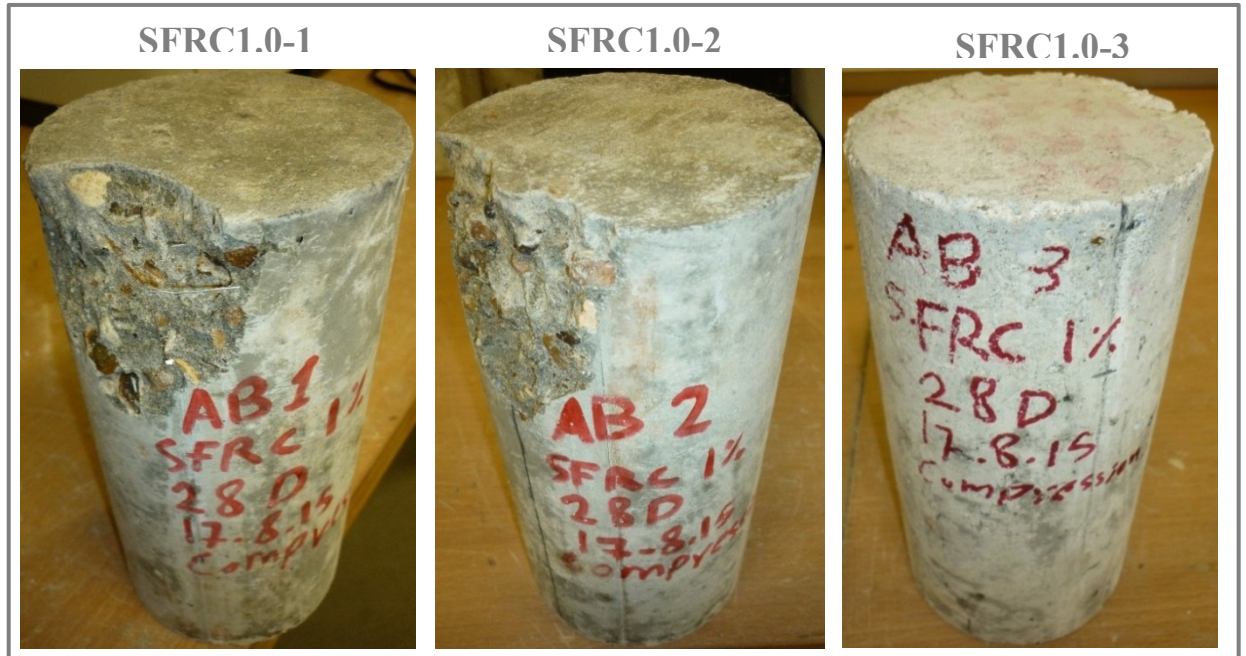

Figure 38. SFRC1.0% samples after the cylinder compression test

The spalling of concrete is also evident in other SFRC samples. For example both first and second samples of SFRC1.0% have this type of failure. Amongst 1.5% steel fiber samples SFRC1.5-2 and SFRC1.5-3 as well as SFRC2.0-4 are similarly failed. However, it should be noted that the damage in samples with 2% is less severe and with smaller area as opposed to samples with less fibers such as SFRC1.0.

Similarly PC4 and SFRC0.5-2 could be compared since both are showing the damage from centre perimeter of the cylinder towards the end and both having close strength of 35.66 MPa and 36.5 MPa respectively. It shows that addition of fibers could be effective in preventing concrete from being crushed into pieces.

SFRC1.5-2 shows a diagonal damage to the cylinder which was observed for other samples as well. However, none of the 2.0% samples showed this kind of damage and the least damage was observed for this concrete type.



Figure 39. SFRC1.0% samples after the cylinder compression test

It is evident that the concrete damage for SFRC with 2.0% fibers is minor and this reveals that the concrete is better held in one piece when higher fiber is used.

As the presence of steel fibers are not evident or visible in areas damaged it can be concluded that the presence of the steel fibers strongly gives the concrete stiffness and coherence to stand the compression force and prevent the breakage of the concrete which is of great advantage and importance in construction industry when concrete is subjected to different loads.



Figure 40. SFRC1.0% samples after the cylinder compression test

#### 4.4.3. Cube VS cylinder Compressive Strength

Table 7. Cube vs cylinder compressive strength

	PC	SFCR0.5%	SFCR01.0%	SFCR1.5%	SFCR2.0%
Cube	37.30	39.80	44.40	45.10	49.20
Cylinder	35.23	36.34	37.39	37.64	38.10
Cube/Cylinder ratio	1.06	1.10	1.19	1.21	1.29

It is evident that the cube compressive strength is higher than the cylinder. This can be attributed to the larger contact area of a 100 mm cube with the loading platen which gives more confinement. Better confinement can resist the expansion of the specimen, hence resulting in more compressive strength.

The cube to cylinder strength ratio is the smallest for the plain concrete while with the increase of fibers in the SFRC this ratio increases. It can be concluded that the higher fiber content affects the confinement of the cubes more and gives a better confinement to resist higher compressive strength.

#### 4.4.4. Split Tensile Test

The split tensile test is used to measure the tensile strength of the concrete. Although this type of test doesn't give the direct tensile strength but it is an indirect method of measuring the tensile strength of the material. A compressive line load along the length of a concrete cylinder placed with its axis horizontal between the compressive platens is applied. The test set up is shown in Figure 36. Fairly uniform tensile stress is developed over nearly 2/3 of the loaded diameter due to the compression loading.

Cylindrical specimens with diameter of 100mm and height of 200mm are used for tests. The test is completed according to BS-EN 12390-6:2009, which recommends to “select a constant rate of loading within the range 0.04 MPa/s (N/mm<sup>2</sup> x s) to 0.06 MPa/s (N/mm<sup>2</sup> × s). Application of the load should be without shock and be increased continuously.” “The required loading rate on the testing machine is given by the formula”:



$$R = \frac{s \times \pi}{2 \times L \times d}$$

Where:

$R$  is the rate of increase of load, in newtons per second;

$L$  is the length of the specimen, in millimetres (see Figure 2);

$d$  is the designated dimension of the specimen, in millimetres;

$s$  is the increase in rate of stress, in megapascals per second, or newtons per square millimetre per second.

According to this guidance a loading rate of 1257 N/s is used. Again in BS-EN 12390-6:2009 the tensile splitting strength is given by the formula:

$$f_{ct} = \frac{2 \times F}{\pi \times L \times d}$$

Where:

$f_{ct}$  is the tensile splitting strength, in megapascals or newtons per square millimetre;

$F$  is the maximum load, in newtons;

$L$  is the length of the line of contact of the specimen, in millimetres;

$d$  is the designated cross-sectional dimension, in millimetres.

The results are calculated based on this formula and presented in Table 7.



Figure 41. Split tensile test set-up

The tensile stress results are compared for all concrete types in Figure 41.

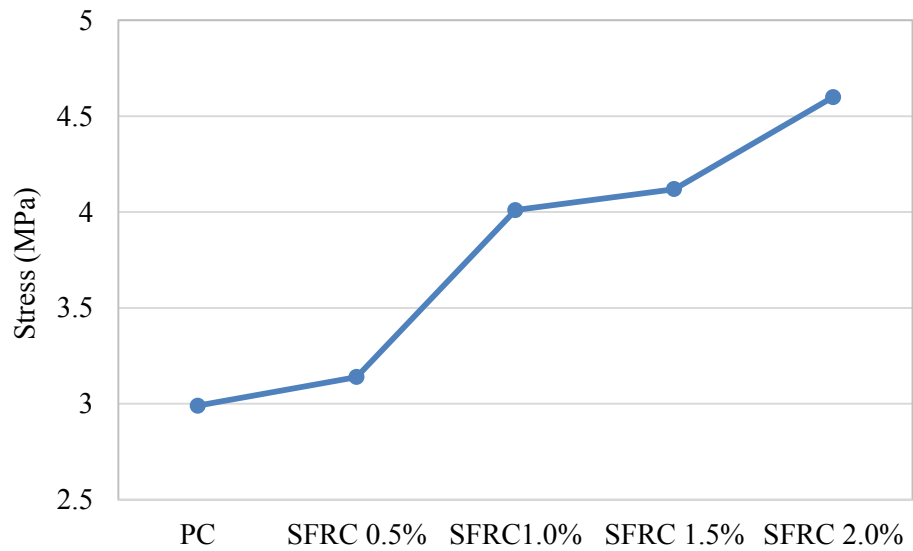

Figure 42. Split Tensile Strength Comparison

Table 8. Cylinder Split Tensile Test Results

Specimen	Sample No.	Specimen	Max Load (kN)	Stress (MPa)	Average Stress
PC	1	Cylinder H200×Ø100 mm	82.85	2.64	2.99
	2		90.4	2.88	
	3		102	3.25	
	4		100.9	3.21	
SFRC 0.5%	1		100.5	3.20	3.14
	2		95.3	3.03	
	3		103.5	3.29	
	4		95	3.02	
SFRC 1.0%	1		137.5	4.38	4.01
	2		127.2	4.05	
	3		128.6	4.09	
	4		111.2	3.54	
SFRC 1.5%	1		129.5	4.12	4.12
	2		130.8	4.16	
	3		131.6	4.19	
	4		126.0	4.01	
SFRC 2.0%	1	139.96	4.46	4.58	
	2	142.85	4.55		
	3	146.92	4.68		
	4	145.45	4.63		

From the strength values it is evident that the split tensile strength of the concrete is increased with the same trend as concrete compressive strength. The increase for the strength from 0.5% to 1% has been more pronounced. The behaviour of 1.0% and 1.5% is more similar in terms of strength. On the other hand, it is important how the fibers affect the failure of the specimens. Figures below compare the specimens after failure. Results show that there is an increase of around 53.3% in splitting tensile strength of the tested specimens with increase in steel fiber content from 0% to 2.0%. Previous test results by Khaloo et al (2014) show an increase of 28.5% in splitting tensile strength of normal weight high-strength concrete with addition of 2% hooked steel fiber content to concrete. Also 1.25% addition of straight fibers in the research

by Iqbal et al. (2015) shows that there is around 37% increase in splitting tensile strength.

Wafa (1990) tested the end hooked fibers under split tensile strength and for volume fractions of 0.5%, 1.0%, 1.5%, and 2.0%. The results showed higher tensile strength by 22%, 53%, 50% and 50% respectively. The fibers in this research showed 5%, 34.1%, 38%, and 53% increase in the split tensile strength. Unlike the results for the 0.5% in this study and Wafa's the results for the 2.0% fiber is similar.

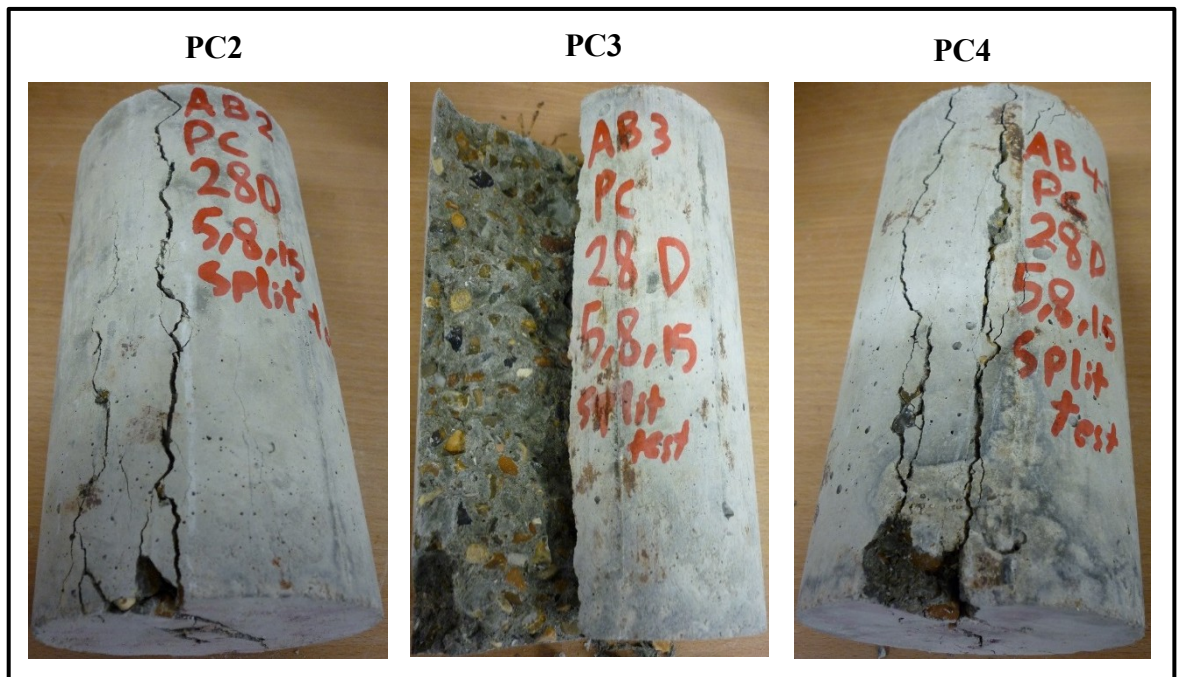

Figure 43. PC Samples after Split Tensile Test

As can be seen the damage pattern in plain concrete is wide cracks through the middle of the cylinder along the line of the applied load. The crack in sample PC3 goes through the whole cross section of the cylinder and splits the cylinder into two pieces. It should be noted that this kind of behaviour was not evident in any of fiber reinforced samples. While SFRC samples only failed with cracks. The crack width varied for different volume fraction of steel fiber samples.

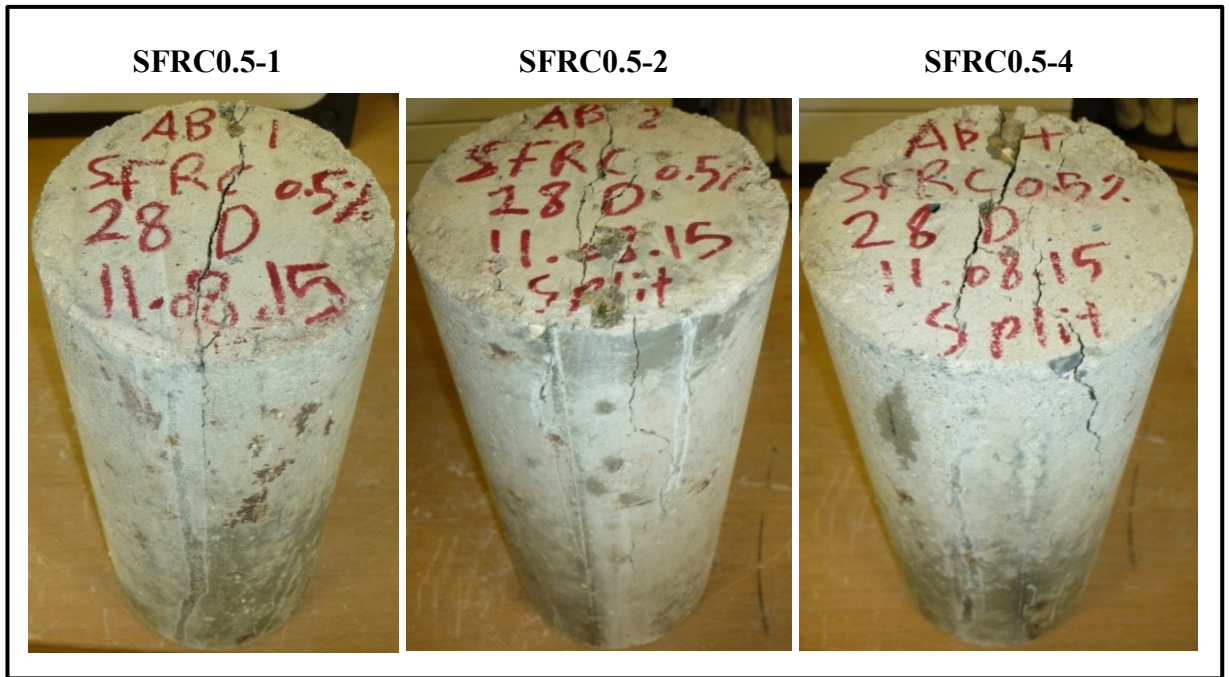

Figure 44. SFRC0.5 Samples after Split Tensile Test



Figure 45. SFRC1.0% samples after split tensile test

Figures 44 and Figure 45 shows that samples have similar failure cracks and pattern however samples with 1.0% fibers show less crack along the sides of the cylinder.

Comparing Figures 46 and 47, samples have very similar failure pattern as both visibly have hair cracks along the sample which is significantly different than plain concrete. For example for Samples SFRC1.5-4 and SFRC2.0-4 the cracks are unnoticeable. This behaviour is solely due to the effect of fibers which increases the

load carrying capacity of the concrete when subjected to tensile stress. The fibers require extra load to be pulled out hence adding to the strength of the material as well as bridging the cracks to stop the quick propagation of the cracks which normally occurs for normal concrete.

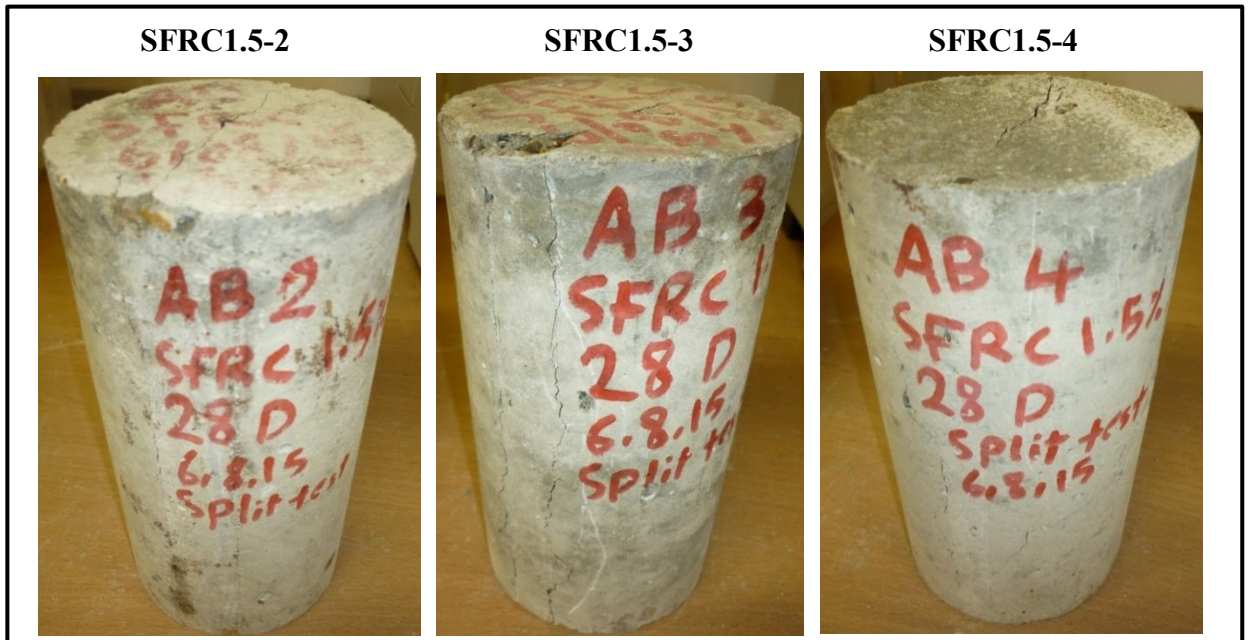

Figure 46. SFRC1.5% samples after split tensile test

It should be noted that the hooked end of the fibers allow for good bonding between the fibers and the concrete hence giving effective behaviour of fibers in the concrete matrix.

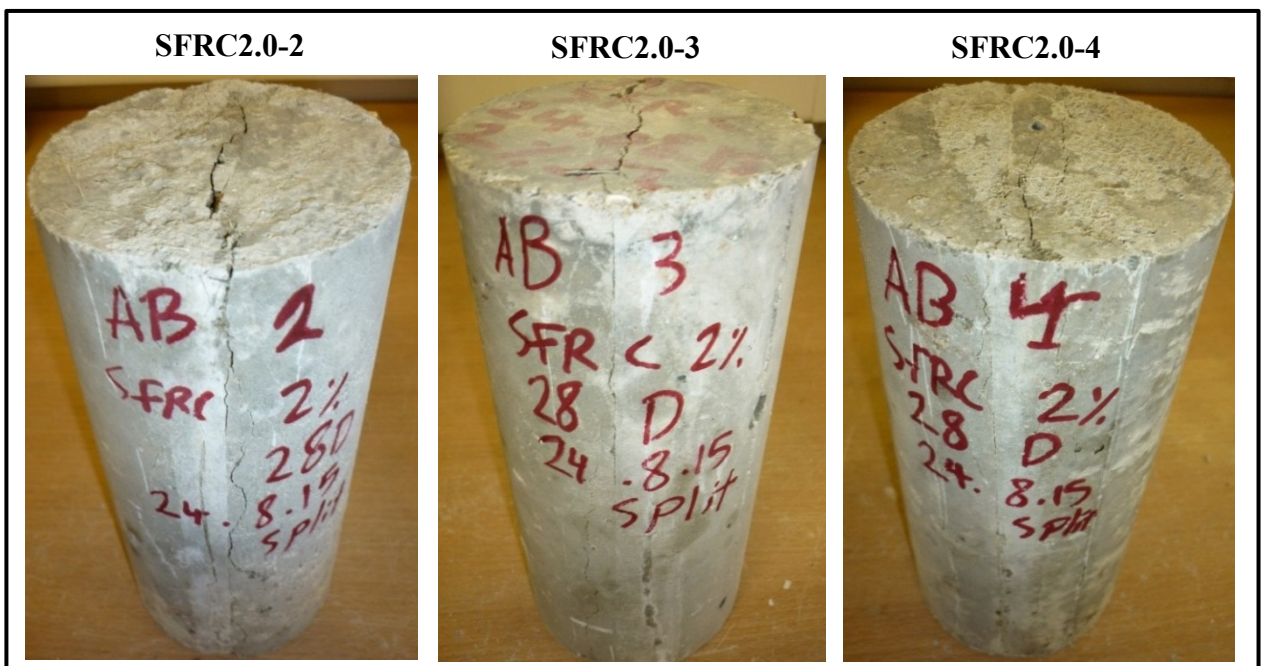

Figure 47. SFRC2.0% Samples after split tensile test

#### 4.4.5. Flexural Beam Test

Flexural beam test is another indirect method of testing and evaluating the tensile strength of the concrete. For each batch numbers of beams were casted to be tested under compression load. The beams had the cross section dimension of  $100 \times 100 \text{ mm}$  and a length of  $500 \text{ mm}$ . The test was a 4-point bending test. Referring to BS EN 12390-5:2000 and as shown in Figure 48, the clear span was set to  $300 \text{ mm}$  and the upper bearer distance was set to  $100 \text{ mm}$ . The displacement at the centre of the beam was measured by the use of two displacement transducers at both sides of the beam. The test set-up is shown in Figure 49.

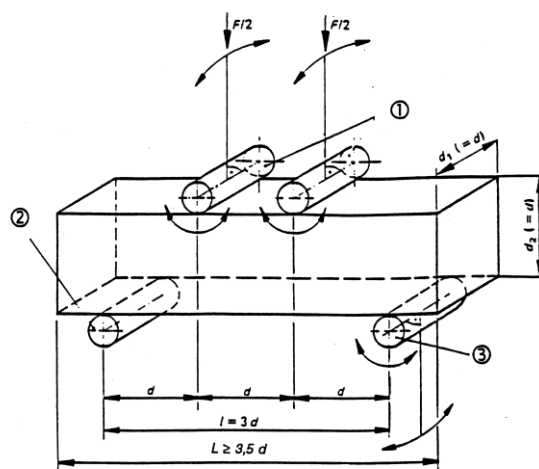

Figure 48. Arrangement of loading of test specimen (BS EN 12390-5:2000)

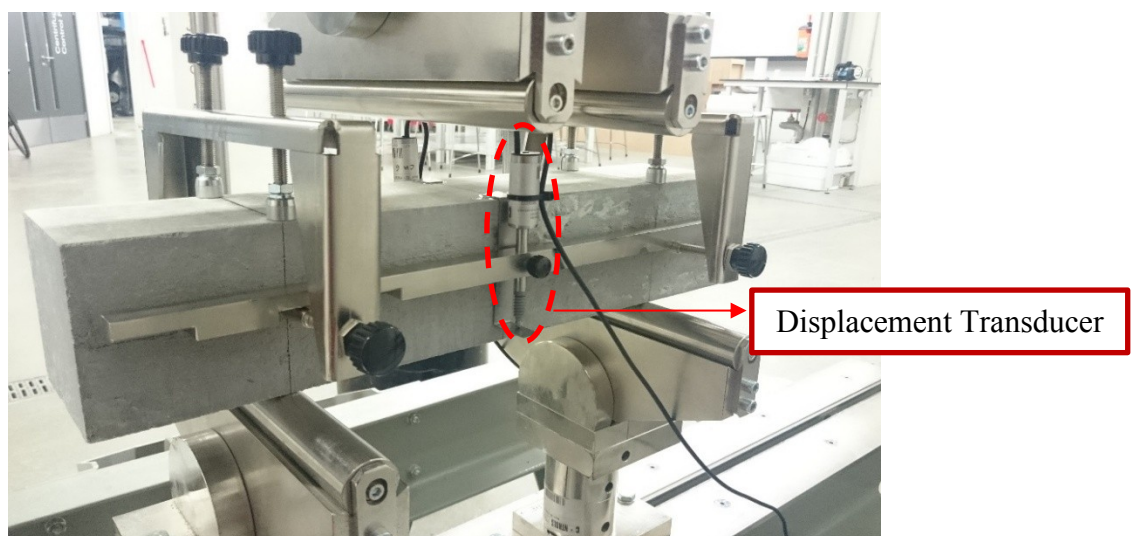

Figure 49. Flexural Beam Test Set Up

The test was conducted under displacement control and the load was applied with a rate of 0.1µm/s. The flexural strength of the concrete derived from BS EN 12390-5:2000 and is given by the following equation:

$$f_{cf} = \frac{l \times F}{d_1 \times d_2^2}$$

Where:

$f_{cf}$  is the flexural strength, in megapascals or newtons per square millimetre;

$F$  is the maximum load, in newtons;

$l$  is the distance between the supporting rollers, in millimetres;

$d_1$  and  $d_2$  are the lateral dimensions of the specimen, in millimetres.

Test results are summarised for all specimen in Table 9.

*Table 9. Flexural Test Results*

Specimen	Sample No.	Specimen	Max Load (kN)	Stress (MPa)	Average Stress
PC	1	Prism 500×100×100 mm	11.41	3.42	3.60
	2		12.44	3.73	
	3		12.18	3.65	
SFRC 0.5%	1		12.72	3.82	3.84
	2		12.31	3.69	
	3		13.37	4.01	
SFRC 1.0%	1		15.34	4.60	4.51
	2		15.71	4.71	
	3		14.01	4.20	
SFRC 1.5%	1		15.48	4.64	4.66
	2		15.89	4.77	
	3		15.21	4.56	
SFRC 2.0%	1		16.26	4.88	5.19
	2		17.64	5.29	
	3		18.04	5.41	



The Average stress results clearly show that the flexural strength of the test is increasing proportionally with the increase of the steel fiber. With the addition of steel fibers in volume fraction of 0.5%, 1.0%, 1.5%, and 2.0% the flexural strength of concrete increased by 6.6%, 25.2%, 29.4% and 44.1% respectively. 2.0% of fibers had the highest effect on the flexural strength while 1.0% and 1.5% had almost similar effect on the strength. Overall the literature suggested the increase of flexural strength by 1.5-3 times higher than plain concrete which in this study the flexural strength is also increased by 1.5 when 2% fibers is used. One of the most important factors that can be concluded from the flexural test is the tensile capacity of the beams. When the beam is loaded the bottom fiber of the beam is under tension. The higher the tensile strength of the beam the better the beam will perform especially after cracking.

The load-displacement graph is plotted by calculating the average displacement of mid-span and shown in Figure 50.

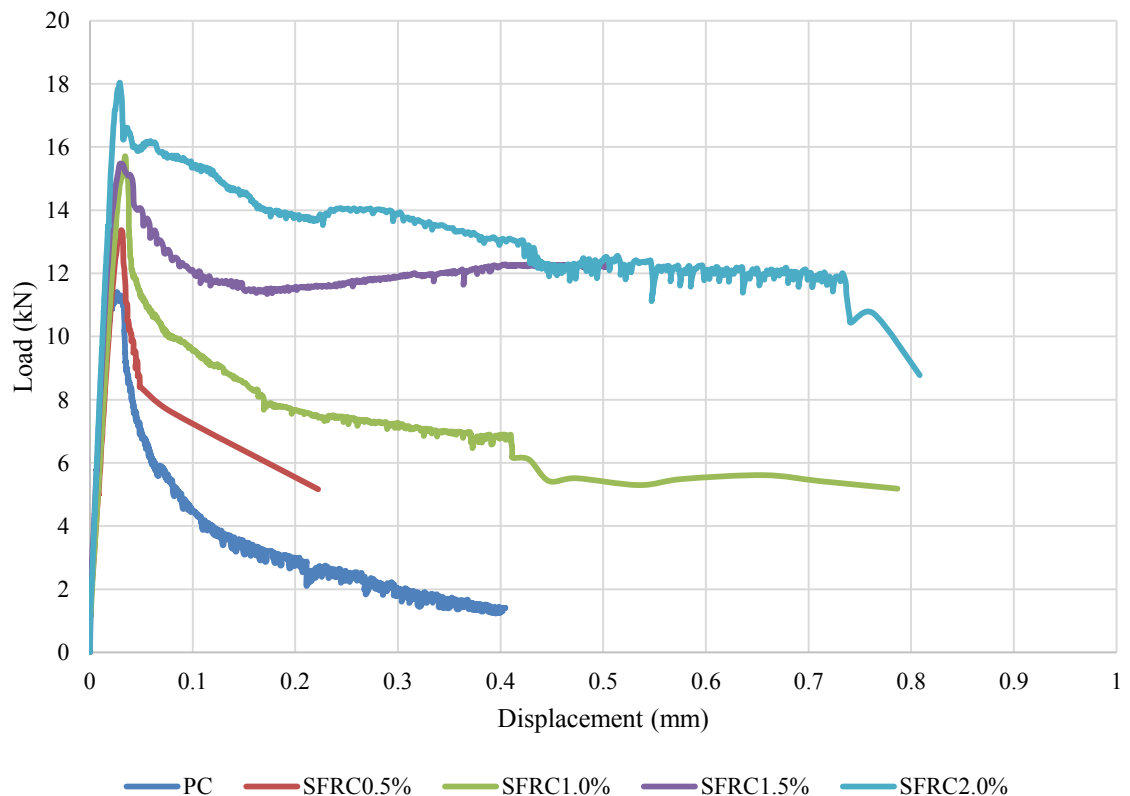

Figure 50. Flexural Beam Test Results

The failure process for the fiber reinforced concrete is that when the beam reaches its maximum flexural strength it starts to crack from the bottom centre point of the

beam, where the concrete is under tensile stress. When the crack starts to form the fibers in the concrete matrix start to take part and prevent the cracks from opening and further propagating similar to that observed in the split tensile test. The effect fibers in between cracks are known as bridging effect and it is more effective when the number of fibers increases. The bridging results in higher load capacity of the beams hence the post-peak behaviour of the beam changes.

Figure 50 shows that the slope of the graph at the post-peak stage gets higher with the presence of the fibers. Comparing plain concrete with SFRC0.5% slight improvement is visible for the concrete with 0.5% fibers. However, In the case of 1.5% and 2.0% of fibers, the post-peak stage has a very gradual reduction trend and at displacement (0.5-0.7mm) almost linear line is obtained. This reflects the high tensile capacity of the beam; therefore higher energy dissipation can be attributed to beams with higher steel fibers. The energy dissipation capacity of the specimen can also be evaluated from the area under the graph.

One of the findings of the flexural strength tests was that the concrete mix with 2.0% steel fiber content exhibits strain hardening behaviour as shown in Figure 51 which is partial representation of Figure 50 with a closer look at the load-displacement behaviour up to 0.1mm displacement. In this part the load decreases from 18kN to 16kN but due to the presence of the fibers with further increase in displacement the load starts to increase up to 17kN and small strain hardening occurs which can be attributed to the higher load that steel fibers can carry. From there the beam succeed to maintain the load capacity at an almost constant load of 16kN.

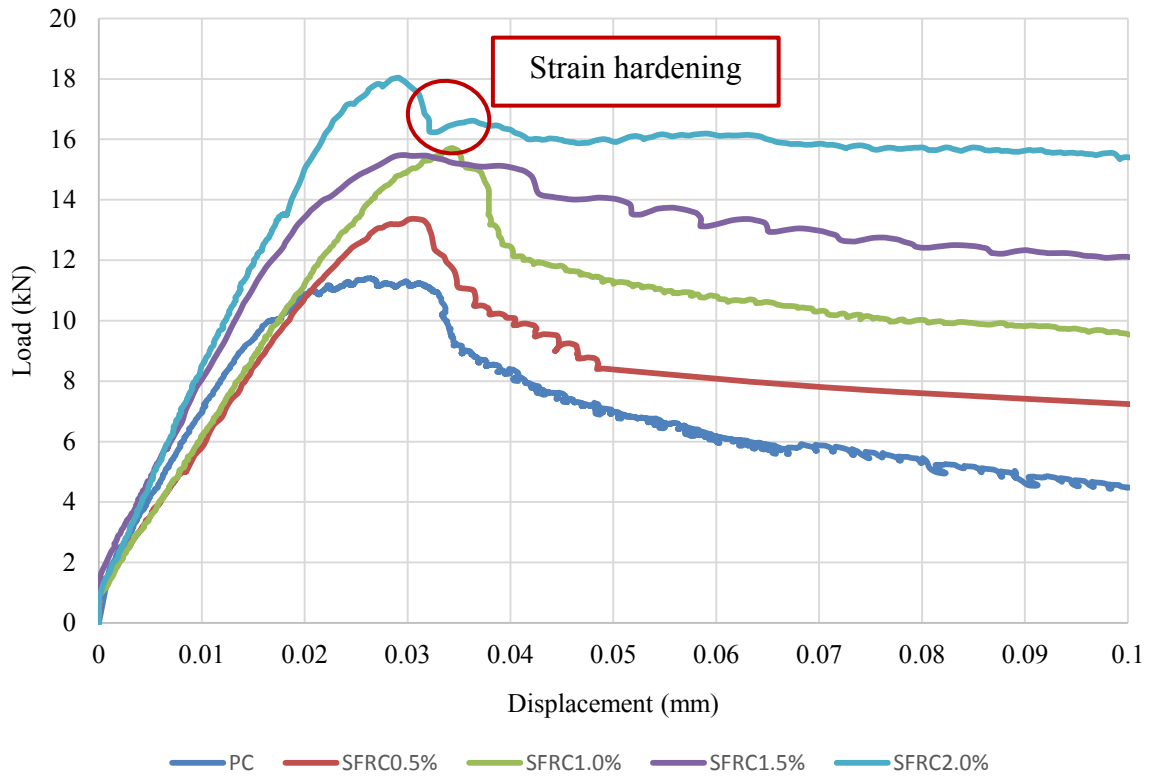

Figure 51. Flexural Beam Test Results (Early stages)

Figures below show the failed specimens for each concrete after the test. Beams that were made of plain concrete show the most severe damage and in all three specimens the beams are broken from the middle.

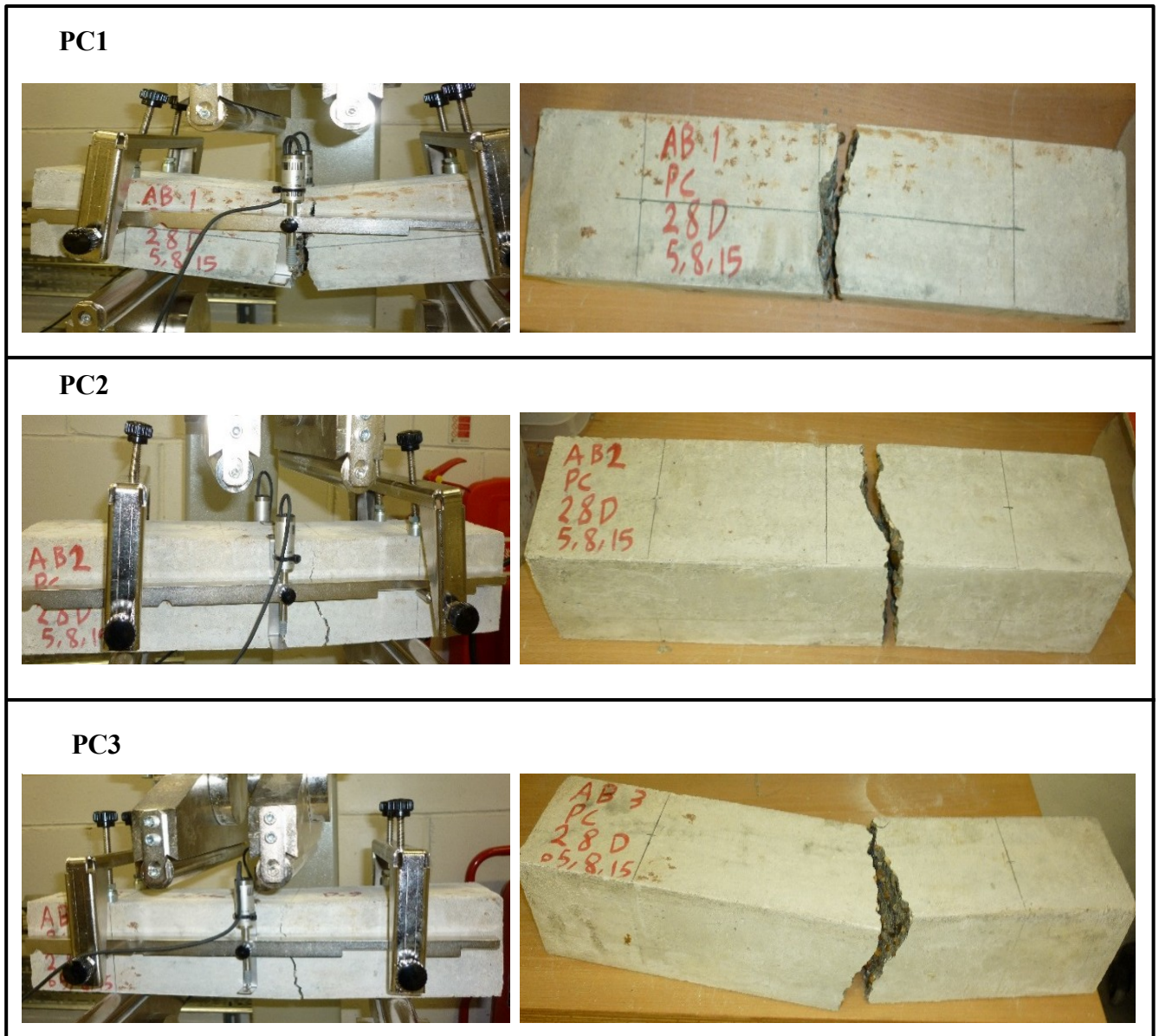
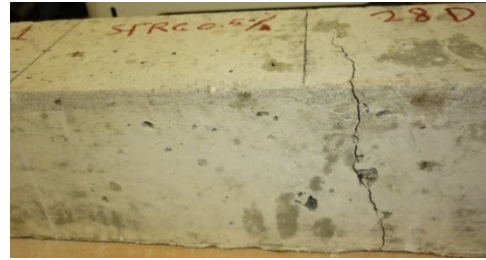
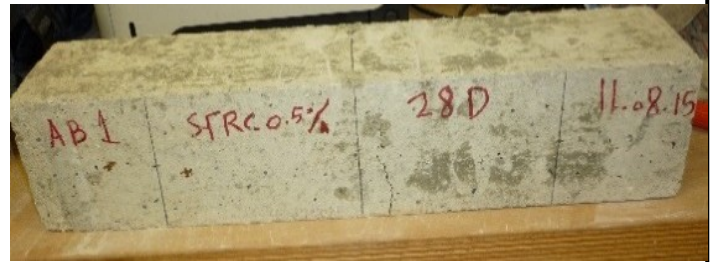
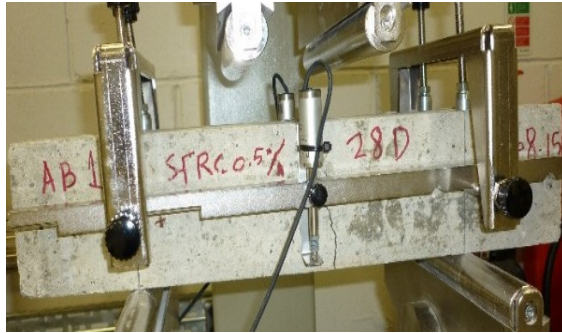

Figure 52. PC beam test results

This behaviour is similar to that of the split tensile strength that was observed for PC2 in which the crack in the specimen made the concrete in to two pieces. In these beams when the crack initiated at the bottom surface of the beam it propagated with a slight increase in load and failed quicker than SFRC samples. Figure 52 shows the crack propagation during the test.

Figure below shows the specimen for SFRC0.5% and cracks formed at the bottom of the beam after the tests are completed. As it is evident these samples are showing a very good performance in terms of bridging the cracks.

**SFRC0.5-1**



**SFRC0.5-2**

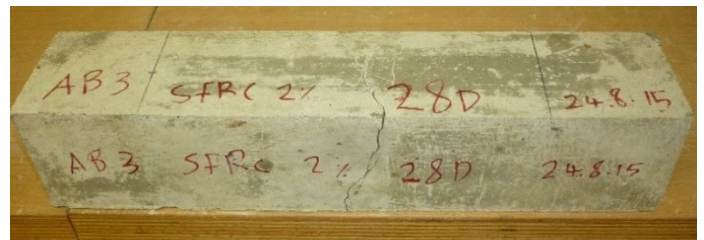

**SFRC0.5-3**

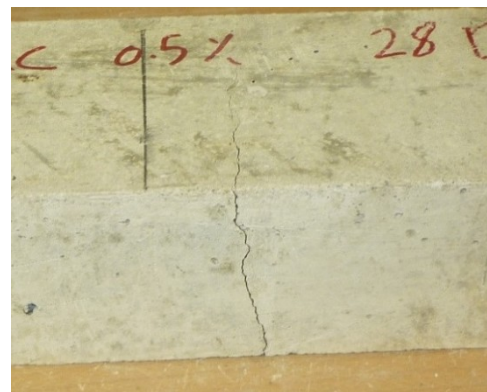

Figure 53. SFRC1.0 Beam Test Results

Similarly the beams with 1.0% fibers show very similar results when compared to SFRC0.5 even though the amount of fibers is doubled. Samples with 1.0% fiber show the cracks to be mainly at the bottom of the beam and slightly towards the centre line of the beam from the side while for SFRC0.5 the crack has more propagation on the sides of the beam as can be seen clearly in sample SFRC0.5-2 that the crack almost reached the top of the beam. This shows the crack was able to propagate in more depth.

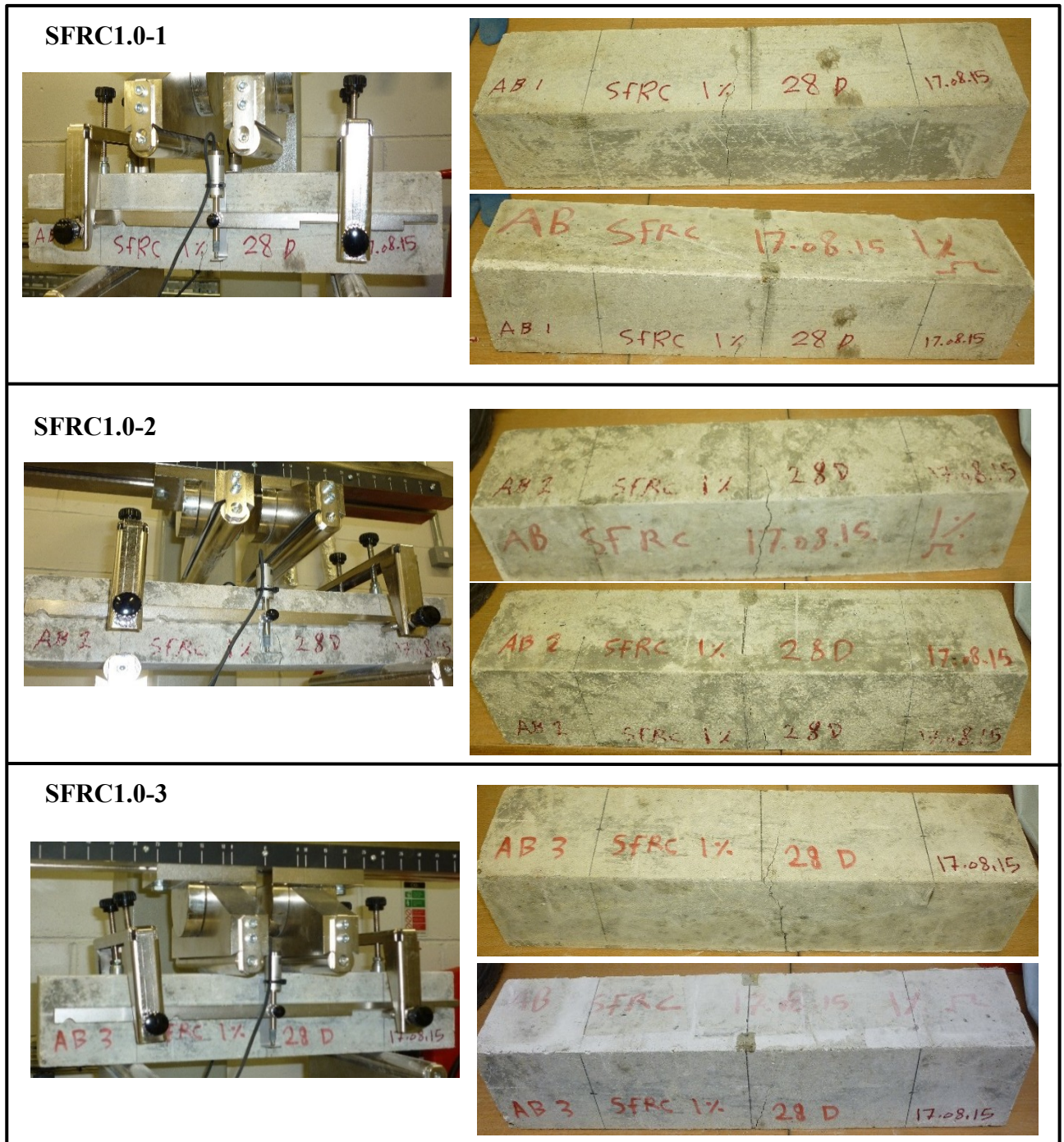

Figure 54. SFRC1.0 Beam Test Results

Samples SFRC1.5-1 and SFRC1.5-3 shows wider crack at the bottom of the beam compared to previous samples discussed, however these beams had higher strength. It can be said that the higher load was required to form the cracks and more resistance from fiber was present resulting in more strength. While the crack for SFRC1.5-2 is very fine.

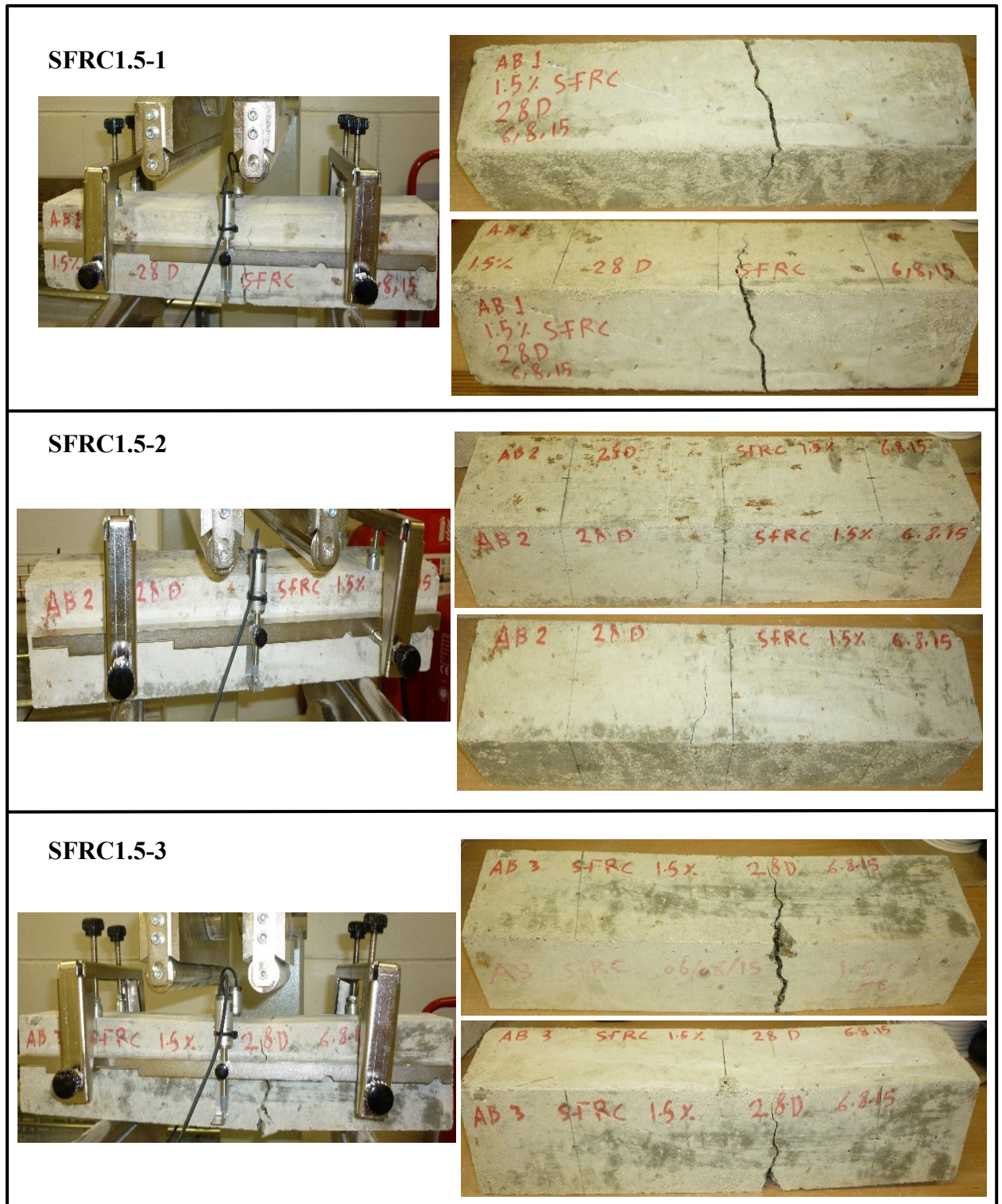

Figure 55. SFRC1.5 Beam Test Results

Figure below shows the performance of SFRC2.0 and it can be seen that it shows the finest cracks at the bottom of the beam and also it is worth mentioning that the depth of the cracks is less than any other SFRC concrete. In SFRC2.0-2 and SFRC2.0-3 the cracks on the side of the beam has only propagated up to 1/3th of the beam depth. This means that the propagation of the crack in the concrete were it is subjected to tensile stresses is significantly due to the presence of the fibers. And the optimum amount of fibers is considered to be 2%.

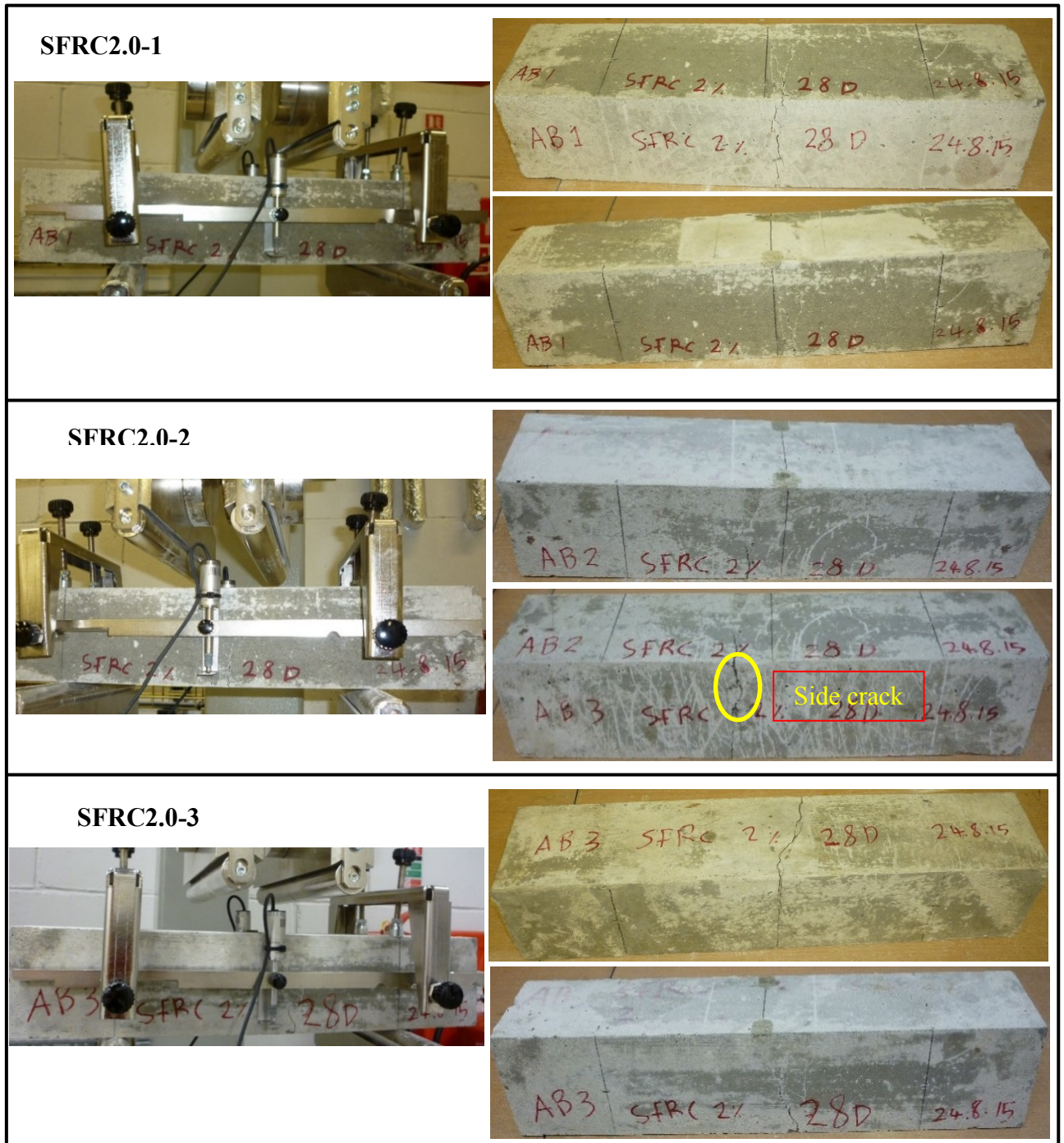

Figure 56. SFRC2.0 Beam Test Results



The cracks at the beam with fibers was delayed while the test was in process and as it can be seen from the figures cracks are not wide and the fibers have successfully stopped the propagation of the cracks. Figure 57 below shows a closer view of the fibers bridging the cracks.

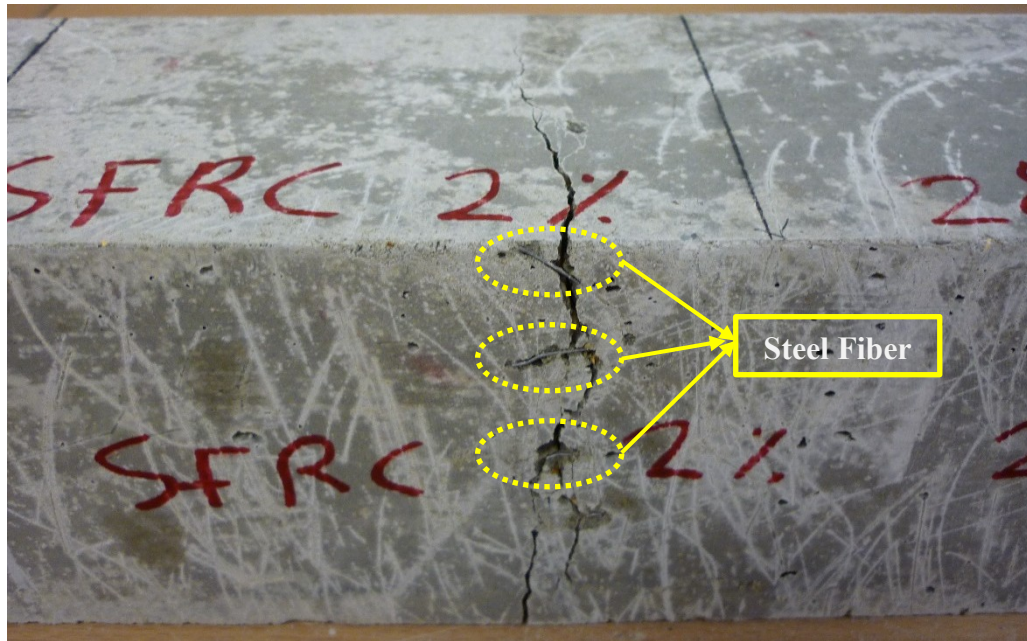

Figure 57. Steel fibers bridging the concrete beam crack under flexure

The fibers geometry which is end hooked have great influence on the bonding of the fibers with the concrete matrix. And it seems that they have been spread reasonably uniform to better enhance the concrete performance.

#### 4.4.6. Relation between split tensile strength and flexural strength

Table 10. Relation between split tensile strength and flexural strength

	PC	SFRC0.5%	SFRC1.0%	SFRC1.5%	SFRC2.0%
Split	2.99	3.14	4.01	4.12	4.58
flexural	3.60	3.84	4.51	4.66	5.19
Flexure/split ratio	1.2	1.2	1.12	1.13	1.13

From Table 10 it can be seen that the ratio between flexural strength and the split tensile strength is almost the same for all mixes. Plain concrete and SFRC0.5% has similar ratio while SFRC1.0% and SFRC1.5% and SFRC2.0% has the same ratio.

This reveals that the relation of the tensile strength and the flexural strength has the same value varying the fiber volume of the steel fibers in SFRC.

#### **4.5. Conclusion**

From the material test it was evident that the use of fibers had great effect on the performance of the plain concrete on all mechanical aspects of compressive strength, split tensile strength and flexural strength. The increase of the fibers from 0.5% to 2.0% showed better performance and amongst these volume fractions the SFRC 2.0% performed the best. Flexural strength increased by 44.1% with the addition of 2.0% fibers. Also, split tensile strength increased by 53.3% and Compressive strength increased by 4.8%. The effect of fiber was more evident and effective on the flexure and tensile strength since the fibers bridge the cracks, giving concrete more capacity under tensile loads.

The optimum value of steel fibers is suggested to be 2.0% as it affects the mechanical performance greatly. Also the literature and industry considers the 2.0% to be a practicable and cost effective amount. However higher volume fractions also have been studied up to 3% and at some cases 5% for ultra-high performance concrete which is a very brittle material compared to conventional plain concrete. It should be noted that this amount of fibers decreases the consistency and workability of the concrete which can be undesirable, therefore the use of additives to enhance the workability would be essential. In conclusion the use of 2.0% of fibers by the volume of concrete is considered to be satisfactory.

## CHAPTER FIVE

### Conclusion and Recommendation

The behaviour of the structural members under extreme loads is quite vital in some applications in structural engineering industry. The development of new materials such as steel fibre reinforced concrete has shown that these can be effective in structural member performance. Research up to date on SFRC has been mostly focused on static performance of members and there is lack of research on the effect of these materials on impact behaviour of slabs with varying parameters in the concrete such as steel fibre type and volume fraction. This research aims to investigate SFRC material behaviour and conclude how SFRC can enhance the performance of concrete hence structural members.

Experimental investigation was carried out on the behaviour of steel fibre reinforced concrete material using end hooked steel fiber with different volume fractions of the fibers consisting of: 0.5%, 1.0%, 1.5% and 2.0% as well as plain concrete with no fibers for comparison. Tests included the cube compression test, cylindrical compression test, split tensile test and flexural test to evaluate the basic material behaviour.

The results showed that the use of fibers enhanced all aspects of material capacity namely compression strength, tensile strength and flexural strength. This was more evident with the increase in the amount of fibers. The performance of SFRC2.0% was the best out of all concrete types while PC showed the highest damage with the least capacity.

Amongst all tests the performance of the specimens under split tensile test and flexural test, which the tensile properties of the concrete are of importance, showed better enhancement. This was due to the effect of fibers and bridging the cracks when concrete starts to crack at its capacity. The presence of fibers increases the load capacity of the samples and makes the concrete a more ductile material as opposed to a conventionally known brittle material. This is very important when designing structural members especially for those under extreme loads such as impact load.

There is lack of research on the behaviour of SFRC under impact using FE analysis, and researchers focused on developing models for normal concrete so far.

According to literature material models such as Concrete Damage Plasticity (CDP) model and Drucker Prager (DP) model are amongst the best to predict the material behaviour.

### **Recommendations**

- Predict the behaviour of SFRC slabs under impact load with the aim of FE and material models to best predict the structural performance.
- Complete experiments including:
  - The uniaxial tension,
  - The biaxial failure in plane state of stress
  - The triaxial test of concrete

To obtain all material characteristics required for the input data of the ABAQUS to accurately model the behaviour of such materials and avoid assumptions.

- Improve modelling of impact load in the finite element analysis programmes.
- Conduct a parametric study on the behaviour of SFRC slabs under impact load using FE analysis investigating following parameters:
  - Volume fraction of steel fibers
  - Aspect ratio of fibers
  - Type of fibers
  - Slab thickness
- Investigate the energy absorption of the slabs under the parametric study.
- Material models in ABAQUS should be further investigated for SFRC and focusing on phenomenon such as impact.

## REFERENCES

1. Achilleos, C. Hadjimitsis, D. Neocleous, K. Pilakoutas, K. Pavlos, O. and Neophytou, S.K. (2011) “Proportioning of Steel Fibre Reinforced Concrete Mixes for Pavement Construction and Their Impact on Environment and Cost”, *Sustainability*, Vol. 3, pp. 965-983.
2. ACI Committee 544. (1989). Measurement of properties of fiber reinforced concrete: American concrete Institute.
3. ACIFC, 1999 “Steel Fiber on Surface”, Association of Concrete Industrial Flooring Contractors, ACIFC Flooring Technical Note 06.
4. Alfonso, J.D. (1991) “Seismic resistance of fibre-reinforced slab-column connection.” *Master Thesis*, William March Rice University.
5. Avenil, S.E. and Samuel, K.G.M. (2014) “Steel Fibre Reinforced Concrete Slabs to Pendulum Impact Test”, *American-Eurasian Journal of Scientific Research*, Vol. 8, pp. 198-205.
6. Belletti, B. Cerioni, R. Meda, A. and Plizzari, G. (2008) “Design Aspects on Steel Fibre-Reinforced Concrete Pavements”, Vol. 10, pp. 899-1561.
7. Bischoff, P. (2003) “Tension Stiffening and Cracking of Steel Fibre-Reinforced Concrete”, *Journal of Material Civil Engineering*, No. 15, Vol. 2, pp. 174–182.
8. Blunt, J. Ostertag, C.P. (2008) “Use of Fibre Reinforced Concrete in Bridge Approach Slabs”, *Civil and Environmental Engineering Department University of California, Berkeley*.
9. British Standards, “Testing hardened concrete - Part 3: Compressive strength of test specimens”, BS EN 12390-3:2002.

10. Buratti, N. Mazzotti, C. and Savoia, M. (2011) “Post cracking behaviour of steel and macro-synthetic fibre-reinforced concretes”, *Construction and Building Materials*. Vol. 25, pp. 2713–2722.
11. Cavill, B. Rebentrost, M. and Perry, V. (2006) “Ductal an Ultra-High Performance Material for Resistance to Blasts and Impacts”, *Conference on Disaster Mitigation*, Canada, 23-26 May.
12. Coetze, C.H. Van der walt, N. (1990) “The Potential of Thinner Concrete Pavements: Evidence from Accelerated testing”, *Proceedings of the 6<sup>th</sup> International Symposium on Concrete Roads*, Madrid, Spain, pp. 21-32.
13. Deidea. K. (2010) “Use of steel fibre reinforced concrete for blast resistant design”, *Master Dissertation*, Kansas State University.
14. Doo, Y.Y. Kyunh, H.M. Jin, Y.L. and Young, S.Y. (2009) “Enhancing impact resistance of concrete slabs strengthened with FRPS and steel fibres”, *South Korea University*.
15. Elavenil, S. and Samuel Knight, G.M. (2012) “Impact response of plates under drop weight impact testing”, *Daffofil International University*”, *Journal of science and technology*, Vol. 7, No. 1, pp. 1-11.
16. Ellouze, A. Ouezdou, M.B. and Karray, M.A. (2010) “Experimental Study of Steel Fibre Concrete Slab and the Behaviour under Uniformly Distributed Loads”, *International Journal of Concrete Structures and Materials* Vol. 4, No. 2, pp. 113-118.
17. Elsaigh, W.A. (2001) “Steel fibre reinforced concrete ground slabs: a comparative evaluation of plain and steel fibre reinforced concrete ground slabs”, *Master Dissertation*, University of Pretoria.

18. Elsaigh, W.A. (2007) “Modelling the behaviour of steel fibre reinforced concrete pavements”, *PhD Thesis*, Transportation Engineering, University of Pretoria.
19. Faisal, F.W. (1990) “Properties and Applications of Fibre Reinforced Concrete”, *JKAU: Eng. Sci.* Vol. 2, pp. 49-56.
20. Falkner, H. Teutch, M. (1993) “Comparative investigations of plain and steel fibre reinforced concrete industrial ground slabs”, *Institut fur Baustoffe, Technical University of Brunswick, Germany*, No. 102.
21. Farnam, Y. Mahoutian, M. Mohammadi, S. and Shekarchi, M. (2008) “Experimental and numerical studies of impact behavior of fibre lightweight aggregate concrete”, *Structures: Crossing Borders*.
22. Farnam, Y. Mahoutian, M. Mohammadi, S. and Shekarchi, M. (2008) “Experimental and Numerical Studies of Impact Behavior of Fibre Lightweight Aggregate Concrete”, *Structures Congress*, Vol. 10, PP. 1-10
23. Fwa, T.F. Paramasivam, P. (1990) “Thin Steel Fibre Cement Mortar Overlay for Concrete Pavement, Department of Civil Engineering”, *Cement & Concrete Composites*, Vol. 12, PP.175-184.
24. Gopalaratnam, V.S. Shah, S.P. Bastan, G.B. Criswel, M.E. Ramakrishnan, V. Wecharatana, M. (1991) “Fracture toughness of fiber reinforced concrete”, *ACI Materials Journal*, Vol. 4, No.88, pp.339-359.
25. Gopinath, S. Ayashawarya, R. Ramesh Kumar, V. Ranjan Prem, P. Murthy, A.R.C. Madheswaran, C.K. and Nageshiyer, R. (2014) “Low velocity impact behaviour of ultra-high strength concrete panels”, *Indian Academy of Science* , Vol. 39, PP. 1497-1507.
26. Graeff, A.G. Pilakoutas, K. Neocleous, K. Vania, N.M.P. (2012) “Fatigue resistance and cracking mechanism of concrete pavements reinforced with

- recycled steel fibres recovered from post-consumer tyres”, *Engineering Structures*, Vol.45, PP.385–395.
27. Haejin, K. (2003) “Behaviour and performance of high performance concrete for pavements”, *Master thesis*, University of Maryland.
  28. Hrynyk, T. (2013) “Behaviour and Modelling of Reinforced Concrete Slabs and Shells Under Static and Dynamic Loads”, *PhD Thesis*, University of Toronto.(To matn nist)
  29. Hrynyk, T.D. and Vecchio, F.J. (2014) “Behaviour of Steel Fibre-Reinforced Concrete Slabs under Impact Load”, *ACI Structural Journal*, Vol. 111, No. 5, pp.1213-1224.
  30. Iqbal, S., Ali, A., Holschemacher, K., and Bier, T. A., (2015) “Mechanical properties of steel fiber reinforced high strength lightweight self-compacting concrete (SHLSCC)” *Construction and Building Materials*, No. 98, pp325-333.
  31. James, H. Abu Bakar, B.H. Ayad, A. A. R. Jayaprakash, J. (2010) “Dynamic response simulation for reinforced concrete slabs”, Vol.18 , PP. 696–711.
  32. Jatale, V.B. and Kalurkar, L.G. (2013) “Punching Shear High Strength Steel Fibre Reinforced Concrete Slabs”, *International Journal of Engineering Research and Applications*, Vol. 3, No. 6, pp. 269-275.(matb nist)
  33. Jeffery, R.R. Salah, A.A. David, A. L. Klaus, A.R. and Gregory, R.U. (2006) “Effect of Synthetic Fibres on Structural Behavior of Concrete Slabs on Ground”, *ACI Material Journal*, No. 103, pp. 3-10.
  34. Jianming, G.W.S. and Keiji, M. (1997) “Mechanical Properties of Steel Fibre reinforced, High-strength, Lightweight Concrete”, *Cement and Concrete Composites*, Vol. 19, pp. 307-313.



35. Jyoti, N. Ajay, G. Devender, S. Kapoor, D.R. Bhupinder, S. (2013) “An Experimental Investigation on Structural Performance of Steel Fibre Reinforced Concrete Beam”, *International Journal of Engineering and Advanced Technology* Vol. 2, No. 6.
36. Khaloo, A., Raisi, E.M., Hosseini, P., Tahsiri, H., (2014) “Mechanical performance of selfcompacting concrete reinforced with steel fibers,” *Constr. Build. Mater.* No.51, pp.179–186.
37. Knapton, J. (2003) *Ground Bearing Concrete Slabs*, London: Thomas Telford Publishing. P24.
38. Kothadia, P., Mishra, C.B., (2015), “LOGICAL ASSESSMENT OF HOOKED END STEEL FIBRE REINFORCED CONCRETE IN M-40 GRADE FOR RIGID PAVEMENT,” *IJRET: International Journal of Research in Engineering and Technology*, Vol. 4, Issue: 01.
39. Luca, G.S. Alberto, M. and Giovanni, A.P. (2006) “Steel Fibre Concrete Slabs on Ground: A Structural Matter”, *ACI Structural journal*, Vol. 103, No. 4, pp.551-558.
40. Luccioni, B.M. Luege, M. (2004) “Concrete pavement slab under blast loads”, *International Journal of Impact Engineering*, Vol.32, PP.1248–1266
41. Madheswaran, C.K. Dattatreya, J.K. Ambily, P.S. and Karansingh, P.R. (2014) “Investigation on behaviour of reinforced geopolymer concrete slab under repeated low velocity impact loading”, *International Journal of Innovative Research in Science, Engineering and Technology*, Vol. 3, No.3.
42. Mahalingam, M. Pulipakka, R. Rao, N. and Kannan, S. (2013) “Ductility Behavior of Fibre Reinforced Concrete Beams Strengthened with Externally

- Bonded Glass Fibre Reinforced Polymer Laminates”, *American Journal of Applied Sciences*, Vol. 10, No. 1, pp. 107-111.
43. Martin, O. (2010) “Comparison of different Constitutive Models for Concrete in ABAQUS/Explicit for Missile Impact Analyses”, *JRC Scientific and Technical Reports, European Commission, Joint Research Centre, Institute for Energy*.
44. Milind, V.M. (2012) “Performance of Steel Fibre Reinforced Concrete”, *International Journal of Engineering and Science*, Vol. 1, No. 12, pp. 01-04.
45. Mohammadi, Y. Ghasemzadeh, H. Talari, T.B. Ghorbani, M.A. (2009) “Replacing Fibre Reinforced Concrete with Bitumen Asphalt in Airports”, *World Academy of Science, Engineering and Technology*, Vol. 3, PP. 10-26.
46. Mokhatar, S. N. and Abdullah, R. (2012) “Computational Analysis of Reinforced Concrete Slabs Subjected to Impact Loads”, *International Journal of Integrated Engineering*, Vol. 4, No. 2, pp. 70-76.
47. Nakin, S. Mirmiran, A. Yohannes, D. (2014) “Use of Fibre Reinforced Concrete for Concrete Pavement Slab Replacement”, *Report prepared by Florida Institute of Technology prepared for: Research Center Florida Department of Transportation*.
48. Nataraja, M.C. Nagaraj, T.S. Basavaraja, S.B. (2005) “Re-proportioning of Steel Fibre Reinforced Concrete Mixes and their Impact Resistance”, *Cement and Concrete Research*, No.35, pp. 2350-2359.
49. Ong, K.C.G. Basheerkhan, M. and Paramasivam, P. (1999) "Resistance of fibre concrete slabs to low velocity projectile impact”, *Cement and Concrete Composites*, Vol. 21, pp. 391-401.

50. Rakesh, K. Pankaj, G. and Renu, M. (2003) "Suitability of Concrete Reinforced with Synthetic Fibre for the Construction of Pavements", *Rigid Pavements Division, Central Road Research Institute*.
51. Rana, A. (2008) "Some Studies on Steel Fibre Reinforced Concrete", *International Journal of Emerging Technology and Advanced Engineering*, Vol. 3, No. 1, pp. 120-127.
52. Rao, H.S. Ghorpade, V.G. Ramana, N.V. and Gnaneswar, K. (2010) "Response of SIFCON two-way slabs under impact loading", *International Journal of Impact Engineering*, No. 37, pp. 452-458.
53. Rashid Dadash, P. Ramezaniapur, A.A. (2014) "Hybrid fibre reinforced concrete containing Pumice and Metakaolin", *Civil Engineering Infrastructures Journal*, Vol. 47, No. 2, pp. 229-238.
54. Razaqpur, A. G. Tolba, A. Contestabile, E. (2007) "Blast loading response of reinforced concrete panels reinforced with externally bonded GFRP laminates", *Composites: Part B*, Vol. 38, Issues 5-6, PP. 535-546.(Not in text)
55. Roesler, J.R. Lange, D. Ulreich, G. (2003) "Fracture Behavior of Full Scale Fibre-Reinforced Concrete Slabs", University of Illinois.
56. Sakthivel, P.B. Jagannathan, A. (2012) "Compatibility study of PVC-coated Weld Mesh in Thin reinforced Cementitious Matrix", *Proceedings of 37<sup>th</sup> Conference on our World in Concrete and Structures*, Singapore, 29-31 August.
57. Sakthivel, P.B. Jagannathan, A. and Padmanaban, R. (2012) "Thin Cementitious Slabs reinforced with Stainless Steel Fibres", *Journal of Mechanical and Civil Engineering*, Vol. 4, No. 2, PP. 39-45.

58. Sakthivel, P.B. Ravichandran, A. and Alagumurthi, N. (2014) “An Experimental Study on Mesh and Fibre Reinforced Cementitious Composites”, *Concrete Research Letters*, Vol. 5, No. 1, pp.722-739.
59. Sangi, A.J. May, M.I. (2009) “High-Mass, Low Velocity Impacts on Reinforced Concrete”, *7<sup>th</sup> European LA-DYNA Conference*, Salzburg, Austria, 14<sup>th</sup> - 15<sup>th</sup> May.
60. Satioglu, A.C. (2009) “Analysis of mechanical behaviour of high performance cement based composite slabs under impact loading”, Thesis.
61. Shaheena, Y.B.I. Soliman, N.M. and Kandil, D.E.M. (2013) “Influence of Reinforced Ferrocement Concrete Plates under Impact Load”, *International Journal of Current Engineering and Technology*, Vol.3, No.4, pp. 1528-1540.
62. Shapiro, N. (1993) “Optimal Fibre Yield Strength for concrete Reinforcement”, *Master Thesis*, Massachusetts Institute of Technology.
63. Sukumar, A., John, E., (2014), “FIBER ADDITION AND ITS EFFECT ON CONCRETE STRENGTH,” *International Journal of Innovative Research in Advanced Engineering (IJIRAE)*, Vol. 1, Issue: 8.
64. Tai, Y.S. Chu, T.L. Hu, H.T. Wu, J.Y. (2011) “Dynamic response of a reinforced concrete slab subjected to air blast load”, *Theoretical and Applied Fracture Mechanics*, Vol. 56 , PP. 140–147.
65. Tan, K. and paramasivam, P. (1994) “Punching Shear Strength of Steel Fibre Reinforced Concrete Slab,” *Journal of Material Civil Engineering*, No. 6, pp.240-253.
66. Tokgoz, S. Dundar, C. Tanrikulu, A.K. (2012) “Experimental behaviour of steel fibre high strength reinforced concrete and composite columns”, *Journal of constructional steel research*, No.74, pp 98-107.

67. Wang, J. (2013) "The Study of Steel Fibre Reinforced Concrete Durability Based on Damage Mechanics", *Research Journal of Applied Sciences*, Vol. 7, PP. 543-550.
68. Wang, W. Zhang, D. Lu, F. Wang, S.C. Tang, F. (2012) "Experimental study on scaling the explosion resistance of a one-way square reinforced concrete slab under a close-in blast loading", *International Journal of Impact Engineering*, Vol. 49, pp. 158-164.
69. Yazici, Y. Arel, H.S. and Tobak, V. (2013) "The effects of impact loading on the mechanical properties of the SFRCs", *Construction and Building Materials*, No. 41, pp. 68–72.
70. Yu, R. Spiesz, P. Brouwers, H.J.H. (2013) "Numerical simulation of Ultra-High Performance Fibre Reinforced Concrete (UHPFRC) under high velocity impact of deformable projectile", *Federal Office of Bundeswehr Infrastructure*, Germany.
71. Yusof, M.A. Nor, N.M. Ismail, A. Sohaimy, R. Daud, N.G.N. Ng Choy Peng, Fauzi, M. Zain, M. (2010) "Measurement of Field Blast Testing Data using High Speed Data Acquisition System for Steel Fibre Reinforced Concrete", *Defence Science Research Conference and Expo*, Singapore, 3-5 August, pp. 1-4.
72. Yusof, M.A. Norazman, Ariffin, Zain, F.M. Risby, Ng, C.P. (2010) "Normal Strength Steel Fibre Reinforced Concrete Subjected to Explosive Loading", *International Journal of Sustainable Construction Engineering & Technology*, Vol. 1, No. 2, pp. 127-136.

73. Zhang, X.X, Abd Elazim, A.M. Ruiz, G. Yu, R.C. (2014) “Fracture behaviour of steel fibre reinforced concrete at a wide range of loading rates”, *International Journal of Impact Engineering*, Vol. 71, PP. 89-96.
74. Zhang, X.X. Ruiz, G. and Yu, R.C. (2008) “A new drop weight impact machine for studying fracture process in structural concrete”, *Strain*, Vol. 46, No. 3, pp. 252-257.
75. Zineddina, M. Krauthammerb, T. (2007) “Dynamic response and behaviour of reinforced concrete slabs under impact loading”, *International Journal of Impact Engineering*, Vol. 34, PP. 1517–1534.