



City Research Online

City St George's, University of London

Citation: Morar, N. I., Holtham, N., Hackel, L., Davami, K., Sharma, M., DeWald, A. & Roy, R. (2024). Effects of high energy laser peening followed by pre-hot corrosion on stress relaxation, microhardness and fatigue life and strength of single crystal nickel CMSX-4® superalloy. *Procedia Structural Integrity*, 57, pp. 625-632. doi: 10.1016/j.prostr.2024.03.069 ISSN 2452-3216 doi: 10.1016/j.prostr.2024.03.069

This is the published version of the paper.

This version of the publication may differ from the final published version. To cite this item please consult the publisher's version.

Permanent repository link: <https://openaccess.city.ac.uk/id/eprint/33034/>

Link to published version: <https://doi.org/10.1016/j.prostr.2024.03.069>

Copyright and Reuse: Copyright and Moral Rights remain with the author(s) and/or copyright holders. Copies of full items can be used for personal research or study, educational, or not-for-profit purposes without prior permission or charge, unless otherwise indicated, provided that the authors, title and full bibliographic details are credited, a hyperlink and/or URL is given for the original metadata page and the content is not changed in any way. For full details of reuse please refer to [City Research Online policy](#).

Concept of information technology for diagnosis and prognosis of glaucoma based on machine learning methods

Volodymyr Kysil^{1,*†}, Peter T. Popov^{2,†}, Olga Drachuk^{3†}, Valentyna Hnenna^{3†} and Inna Martyniuk^{1,†}

¹ Khmelnytskyi National University, Institutyska str., 11, Khmelnytskyi, 29016, Ukraine

² City University of London, Northampton Square, London, EC1V 0HB, United Kingdom

³ National Pirogov Memorial Medical University, Pirogova str., 56, Vinnytsya, 21018, Ukraine

Abstract

The current challenge is early and automated diagnosis and prognosis of glaucoma using information technology based on machine and deep learning methods. The conducted analysis of the methods and tools for diagnosing and predicting the glaucoma has shown that now there are many such methods and tools, including those based on machine learning and deep learning, but all of them have certain drawbacks, such as their "niche" (lack of mass use, development of tools exclusively for proving and testing the theoretical positions developed by the authors), complexity of development, complexity of use, high cost, the need for an ophthalmologist to decipher the data obtained, etc. Therefore, the aim of this study is to develop the information technology for diagnosis and prognosis of glaucoma based on machine learning methods, which will have minimal requirements and resource needs, be characterized by low cost and mass use, and will not require an ophthalmologist to decipher the data generated by the neural network. The proposed information technology for diagnosis and prognosis of glaucoma based on machine learning methods automates the processing of fundus retinal images and optical coherence tomography images based on machine learning in order to automatically diagnose glaucoma at early stages by classifying the eye as normal or glaucomatous.

Keywords

glaucoma, glaucoma diagnosis, glaucoma prognosis, machine learning, information technology.

1. Introduction

Globally, glaucoma is the second most common cause of blindness and subsequent disability [1, 2]:

IntellTSIS'2024: 5th International Workshop on Intelligent Information Technologies and Systems of Information Security, March 28, 2024, Khmelnytskyi, Ukraine

* Corresponding author.

† These authors contributed equally.

✉ vovikusspambox@gmail.com (V. Kysil); p.t.popov@city.ac.uk (P. Popov); drachuk@vnmue.edu.ua (O. Drachuk); valentina.gnenna@gmail.com (V. Hnenna); Inmartunyk@ukr.net (I. Martyniuk)

ORCID 0009-0003-9387-6609 (V. Kysil); 0000-0002-3434-5272 (P. Popov); 0000-0002-0504-4059 (O. Drachuk); 0000-0002-0058-8399 (V. Hnenna); 0009-0007-7751-8974 (I. Martyniuk)



© 2023 Copyright for this paper by its authors. Use permitted under Creative Commons License Attribution 4.0 International (CC BY 4.0).

- cataracts (47.9 %)
- glaucoma (12.3 %)
- vision loss associated with aging (8.7 %)
- corneal opacity (5.1 %)
- diabetic retinopathy (4.8 %)
- blindness in children caused, in particular, by vitamin A deficiency, cataracts and retinopathy of prematurity children (3.9 %)
- trachoma (3.6%)
- onchocerciasis (0.8%)

Glaucoma is a neuropathy of the optic nerve accompanied by characteristic structural and functional changes [1]. Glaucoma is a retinal disease that damages the optic nerve due to the accumulation of excess fluid in the front of the eye. Excess fluid produced in the eye leads to an increase in intraocular pressure, thereby causing irreversible blindness.

Glaucoma affects more than 90 million people worldwide [2]. The number of people aged 40-80 years with glaucoma worldwide was estimated at 64.3 million in 2013, about 76.0 million in 2020, and is projected to reach 111.8 million in 2040 [3].

The main problem in detecting glaucoma is that signs and symptoms may appear only when vision is already significantly lost. Due to the asymptomatic and slowly progressive nature of glaucoma, many people are unaware of their disease for a long time, and clinical practice continues to face difficulties in detecting and predicting glaucoma, especially in the early stages. However, early detection of glaucoma can slow down the progression of the disease and prevent future vision loss.

Since glaucoma damages the retina due to damage to the optic nerve head with increased intraocular pressure, it is necessary to segment the optic disc when detecting glaucoma, which is a challenge due to its extremely small size and blockage of blood vessels.

For the diagnosis and monitoring of glaucoma, specialists use such imaging methods as fundus retinal imaging and optical coherence tomography. Fig. 1 shows the optical coherence tomography images of healthy (normal) eye and glaucomatous (abnormal) eye.

Diagnosis of glaucoma usually involves assessing the condition of the optic nerve head by examining the retina, measuring intraocular pressure, evaluating visual fields, and examining other related factors [4]. Consequently, glaucoma is extremely difficult to detect in the early stages using conventional methods that rely on the experience of ophthalmologists, take a long time and are prone to human error.

An expert ophthalmologist examines the retina to see how glaucoma is progressing. This method is quite labor-intensive and takes a long time to perform manually. Optical coherence tomography provides many parameters to obtain comprehensive information, and ophthalmologists can be confused when the results contradict each other. Diagnosing eye diseases using manual diagnostics by a doctor can be very expensive and time-consuming [5]. In addition, the manual procedure for diagnosing glaucoma is associated with frequent human errors, which is why alternative technological diagnostic methods are preferred.

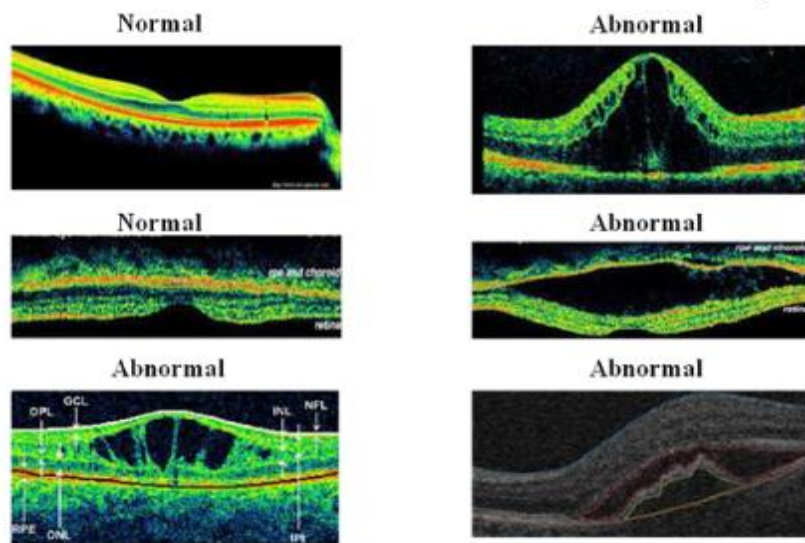

Figure 1: Optical coherence tomography image of healthy (normal) eye and glaucomatous (abnormal) eye.

A promising area for supporting healthcare professionals in improving their decision-making processes, which ultimately improves the quality of treatment of patients with retinal abnormalities, is modern information consultative and diagnostic technologies, which are currently represented by numerous systems for diagnosing pathological conditions in diseases of various profiles and for different categories of patients [6-8]. The main field of application of information consultative and diagnostic technologies is urgent and life-threatening conditions characterized by a lack of time, limited opportunities for examination and consultation, as well as low clinical symptoms with a high level of threat to the patient's life and health and at a rapid pace of development of the process [9, 10]. Therefore, it is obvious that the diagnosis of glaucoma is precisely the area where it is worthwhile and appropriate to use information counseling and diagnostic technologies.

For automatically diagnose and predict glaucoma, an information-based diagnostic technology must process a large number of fundus retinal and optical coherence tomography images and a large amount of data from these images. Data analysis and processing are critical as the amount of ophthalmic image data generated continues to grow at a frantic pace. Therefore, AI models that can outperform humans in tasks such as image recognition should be used to solve this problem [11]. Artificial intelligence is the best solution for rapid glaucoma detection with high accuracy.

Over the past decade, machine learning and deep learning methods have evolved to not only improve detection, speed up the processing of large amounts of images and data, but also make it easier for a doctor to diagnose the disease. It has been proven that, using deep and machine learning methods, it is possible to automatically diagnose glaucoma in the early stages by processing fundus retinal and optical coherence tomography images to classify the eye as normal or glaucomatous [12].

Therefore, the current challenge is early and automated diagnosis and prognosis of glaucoma using information technology based on machine and deep learning methods.

2. Literature Review

Let's consider the known methods and tools for diagnosing and predicting the glaucoma.

Authors of [4] investigated the applying machine learning and deep learning techniques to multiple modalities of retinal data (visual fields for glaucoma detection, fundus retinal images, etc.). They discuss advantages and disadvantages of machine learning and deep learning techniques application in glaucoma diagnosis and propose requirements for the development of AI methods in glaucoma diagnoses. Various types of machine learning models applied to glaucoma is represented on Fig. 2, various types of deep learning models applied to glaucoma is represented on Fig. 3 [4].

Paper [5] proposed method "EyeCNN" for identifying eye diseases (diabetic retinopathy, glaucoma, and cataract) early through retinal images using the selected EfficientNet B3 form the 12 investigated convolutional networks. The use of EyeCNN for early identifying and classifying eye diseases helps to aid ophthalmologists in accurately and efficiently diagnosing, and in choice of treatment methods.

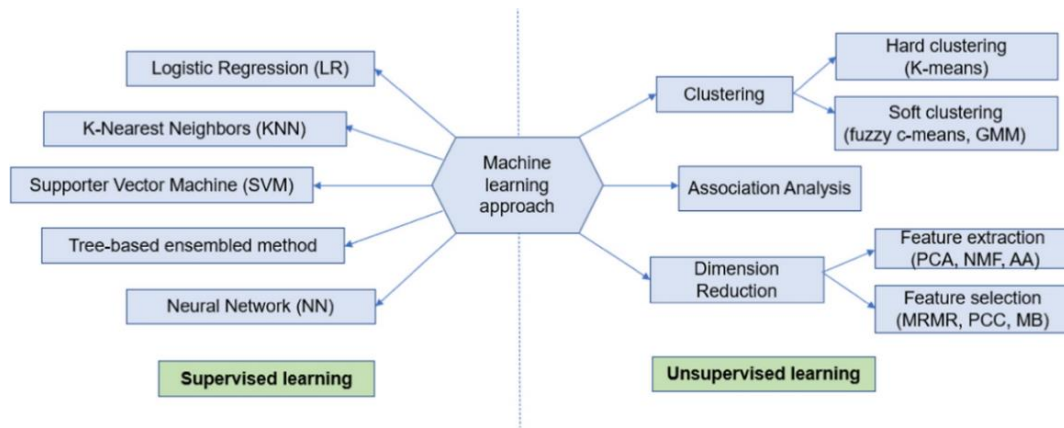

Figure 2: Various types of machine learning models applied to glaucoma [4].

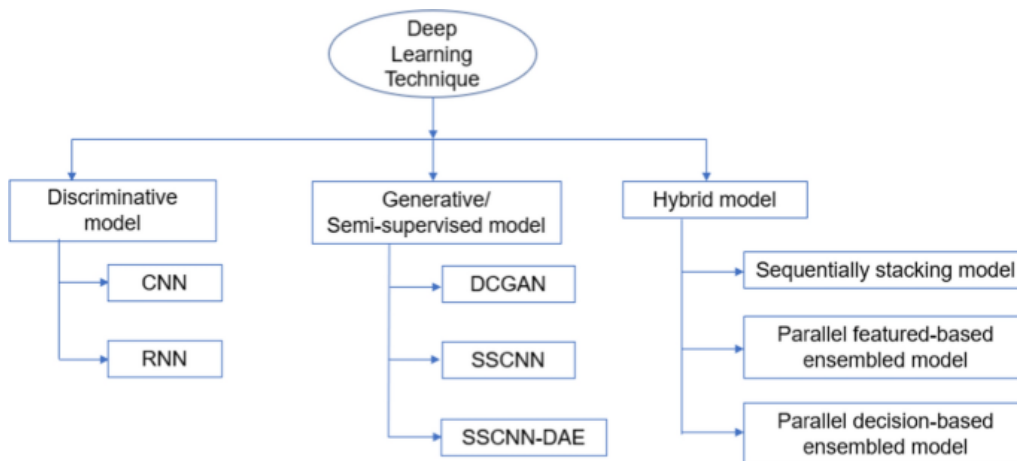

Figure 3: Various types of deep learning models applied to glaucoma [4].

Paper [13] developed the deep learning model for diagnosing the early glaucoma from spectral-domain optical coherence tomography images, which provides the substantive increase in diagnostic performance.

Proposed in [14] deep learning models use derived parameters of optical coherence tomography including retinal nerve fiber layer scans, optic nerve head scans, macular scan, and combination of these parameters, for achieving the high diagnostic accuracy in detecting the glaucomatous optic neuropathy. The developed models are objective, time-efficient, and have a potential in the glaucoma prognosis and treatment.

Authors of [15] developed the efficient computer-aided detection system for diagnosing the glaucoma based on fuzzy aggregation operators and deep transfer learning for fundus images processing. Proposed system provides detecting the region of interest of the optic disc with the efficient deep learning network, classification of images based on different pre-trained deep convolutional neural networks and support vector machines, and use of fuzzy aggregation operators (ordered weighted averaging operator, weighted power mean, and exponential mean) for combining the predictions of glaucoma classifiers.

The research [16] applies the Restricted Boltzmann Machines to the glaucoma detection. This model accurately categorizes the anomalies and automates the diagnostic process by extracting and analyzing multiple features from retinal images. The model's robustness, performance and accuracy provides the support for healthcare professionals in enhancing the quality of care for patients with retinal anomalies.

Paper [17] proposed the automated system for segmentation of optic disc along with classification of healthy images from glaucomatous ones. Authors achieved efficient results via deploying super pixel based red channel and via selection of Hough peak value for segmenting optic disc while early diagnosing glaucoma. Moreover, authors found that support vector classifier is best suited for classification while focusing on removal of blood vessels.

Paper [18] constructed a Hybrid Deep Learning Algorithm CAPSGAN for effective glaucoma detection and creation of a toolkit for diagnosing the disease. The proposed CAPSGAN creates the synthetic images using the Generative Adversarial Network, where Caps-Net was the best option for effective picture categorization.

Paper [19] studied the various machine learning and deep learning techniques with the various datasets for glaucoma detecting on the basis of the analysis of Optic Nerve Head, Optic cup and Optic Disc in the retina.

Authors of [20] used concept Fastai for the choice of the convolution neural network and by reducing the parameters to a large extent for the dataset consisting of retinal images consisting of those infected with glaucoma and non-glaucoma images (named as healthy). They used ResNet34 model via Fastai and achieved Accuracy metric equal 90.54%.

Authors of [21] developed the AI- and IoT-based predictive model for classification and prediction of glaucoma disease through continuous monitoring of optical coherence tomography images. The proposed model facilitates the collection of health data from patients through IoT devices. Authors also developed the unique automated AI-based (machine learning and bio-inspired computing approaches) IoT embedded system for glaucoma screening. This system proposed the remotely access to aid ophthalmologists in glaucoma diagnosing and treating.

Paper [22] proposed the combined framework, which involves combination of predicted classes from machine learning and deep learning techniques using Major Voting and Weighted Decision Fusion. Such framework could be beneficial for examining glaucomatous patients using optical coherence tomography images.

Authors of [23] used convolutional neural network with CNN architecture and human-in-the-loop data annotation from TrueColor confocal fundus images for diagnosing the glaucomatous damage. This neural network helps not only in diagnosing glaucoma but also in predicting and locating detailed signs in the glaucomatous fundus (glaucomatous optic atrophy, splinter hemorrhages, parapapillary atrophy, vertical glaucomatous cupping, and retinal nerve fiber layer defect).

Paper [24] proposed the automatic or self-diagnosing deep learning-based method for detecting Diabetic Retinopathy, Glaucoma and Cataract within a minute with high prediction rate. Authors of [24] also developed the online DCNN-based expert system with user-friendly, interpretable, online graphical user Interface for diagnosing three above diseases.

Paper [25] investigated the machine learning classifiers as the tools for considering numerous parameters and generating reliable diagnoses of glaucoma on the basis of optical coherence tomography images, during random forest was shown to be the best model. Paper [26] analyzed and evaluated the different techniques of glaucoma's and diabetic retinopathy 's diagnosis and categorization using retinal images.

Study [27] developed the automatic deep learning- and deep-belief network-based computer-aided diagnostics framework for diagnosing the glaucoma eye disease by handcrafted feature-based segmentation in retinal images. Study [27] also developed the contextualizing deep learning structure for obtaining various levels of portraying fundus images for classification of glaucoma and non-glaucoma.

Paper [28] proposed using the machine learning models to elaborate the cost-effective and portable decision support system for comprehensive glaucoma screening. The proposed system considers eye gaze features for understanding cognitive processing, direction and restriction of visual field.

Paper [29] developed the cost-effective algorithmic method with graphical user interface by Matlab for identifying the primary open-angle glaucoma. The proposed method is a multivariate approach based on the K-means clustering concept in segregating the optic disc and cup from retina, measures the cup-to-disc ratio vertically and horizontally, and estimate neuro retinal rim area.

Paper [30] considered the machine learning approaches, which are used for retinal vessels segmentation, and methods of retinal layers and fluid segmentation (color fundus imaging, and optical coherence tomography).

The conducted analysis of the methods and tools for diagnosing and predicting the glaucoma has shown that now there are many such methods and tools, including those based on machine learning and deep learning, but all of them have certain drawbacks, such as their "niche" (lack of mass use, development of tools exclusively for proving and testing the theoretical positions developed by the authors), complexity of development, complexity of use, high cost, the need for an ophthalmologist to decipher the data obtained, etc. Therefore, *the aim of this study* is to develop an information technology for diagnosis and

prognosis of glaucoma based on machine learning methods, which will have minimal requirements and resource needs, be characterized by low cost and mass use, and will not require an ophthalmologist to decipher the data generated by the neural network.

3. Concept of Information Technology for Diagnosis and Prognosis of Glaucoma Based on Machine Learning Methods

Let's develop the concept of information technology for diagnosis and prognosis of glaucoma based on machine learning methods (set of processes for accumulating, processing and transmitting initial information to information product). Structure of this information technology is represented on Fig. 4.

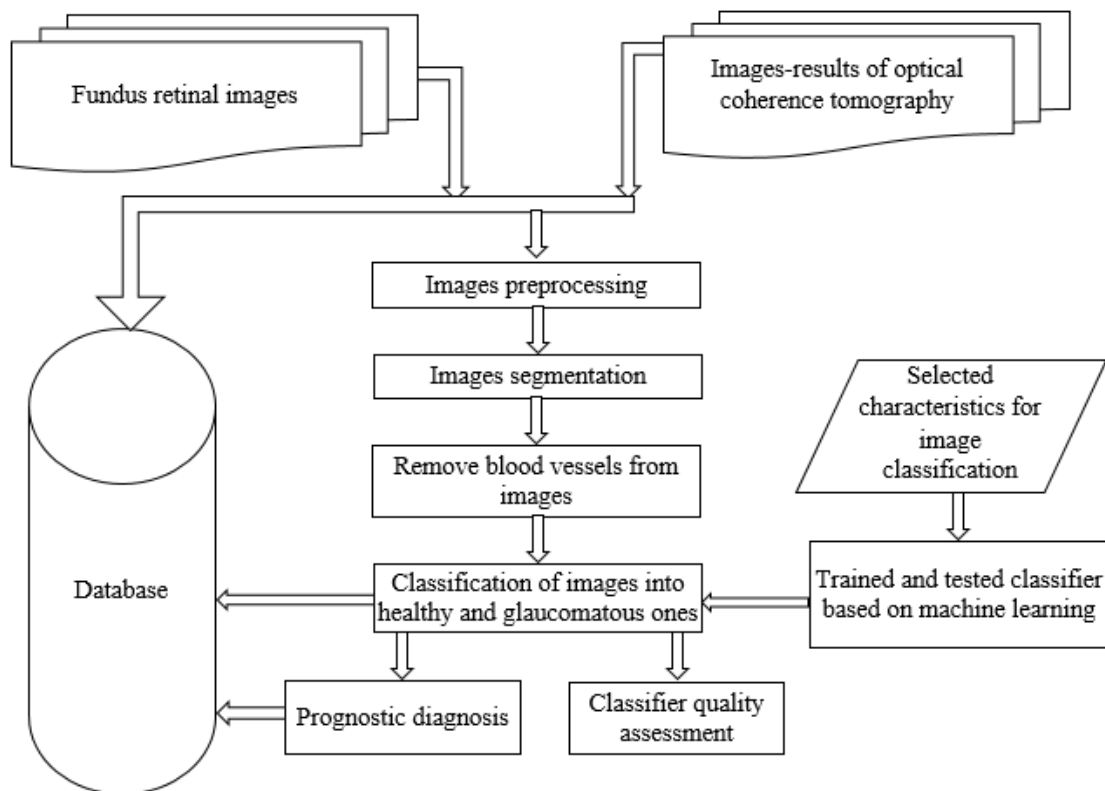

Figure 4: Structure of information technology for diagnosis and prognosis of glaucoma based on machine learning methods.

The proposed information technology for diagnosis and prognosis of glaucoma based on machine learning methods automates the processing of fundus retinal images and optical coherence tomography images based on machine learning in order to automatically diagnose glaucoma at early stages by classifying the eye as normal or glaucomatous.

The initial information in the information technology for diagnosis and prognosis of glaucoma based on machine learning methods is the fundus retinal image and optical coherence tomography images.

The obtained fundus retinal images and optical coherence tomography images are stored in the database and processed, including image preprocessing (grayscale adjustment, resizing, power transformation, etc.), image segmentation, removal of blood vessels from the images, classification of images into healthy and glaucomatous ones (performed by the binary trained and tested classifier a_c , which works on the basis of machine learning methods). The classification task is as follows: for a dataset $X_c = \{x_1, \dots, x_a\}$ (fundus retinal images and optical coherence tomography images) and known binary responses $Y_c = y(X_c) \in \{0;1\}$ (conclusion about a glaucomatous (0) or healthy (1) eye) there is a method a_c (solution function, strategy, etc.), that approximates Y_c on the entire set of objects X_c , i.e. $a_c: X_c \rightarrow Y_c$. Based on the conducted automatic classification, a prognostic diagnosis is generated and provided to the user in a form accessible to the user. The results of the classification and the generated prognostic diagnoses (information technology products) are also accumulated in the database.

In addition, if there is a set of made decisions, the decisions are evaluated. For evaluation of the made decisions, the quality metrics of the binary classifier Accuracy, Precision, Recall, F1, Specificity and the AP metric based on the built Precision-Recall curve and AUC metric based on the built ROC curve are calculated, and their values are analyzed (for example, a high value of the F1 metric indicates the stability of the approach to the uneven number of normal and abnormal samples in the dataset, etc.).

4. Results & Discussion

Let's consider the work of the proposed information technology for diagnosis and prognosis of glaucoma based on machine learning methods. For the first experiment, we used a dataset of 6 fundus retinal images labeled by ophthalmologists. Currently, the dataset used has not been analyzed for the quality of its labeling, data balance, and data representativeness - this will be the focus of further research by the authors.

All images were reduced to the same size of 640 (64 * 10) pixels with bicubic smoothing, converted to black and white (to save training time and to increase contrast) - Fig. 5, then a mask representing the vessels was manually created for each image. Then, before training, the images and masks were segmented into 72*72 pixel tiles with a step of 32 vertically and horizontally, and the segmentation tiles also received random transformations (rotation by a multiple of 90°, reflection) to narrow the field of attention. In addition, it was empirically found that it is easier to select and remove blood vessels in small areas. Fig. 6 shows an image of the retina with blood vessels, Fig. 7 shows the image with blood vessels removed, because, as discussed above, glaucomatous changes in the retina do not affect blood vessels, so blood vessels can be removed from the image to remove an extra class of pixels that the neural network will pay attention.

The neural network (a binary classifier based on machine learning) consists of 16 layers - the first 12 layers are 16 neurons thick, the next 8 neurons thick to concentrate processing, the activation function between the layers is *leakyrelu* to prevent deadlocks and provide feedback between the layers, and the last layer is processed with a sigmoid function to obtain the final result. It will be quite easy to retrain such a network on larger and better data sets.

The task of the authors' future research will be to form and study a larger and better dataset, improve the quality and accuracy of image preprocessing and classification.

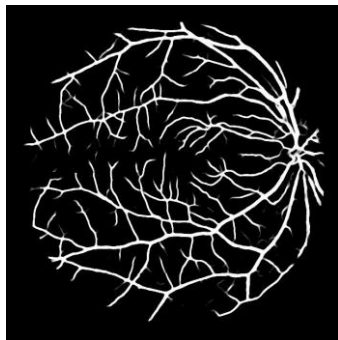

Figure 5: Black and white image of the retina.

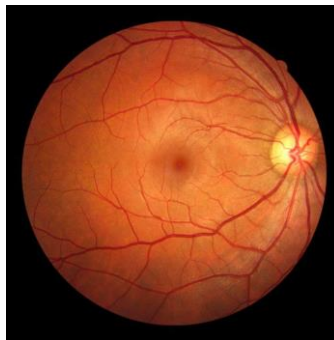

Figure 6: Image of the retina with blood vessels.

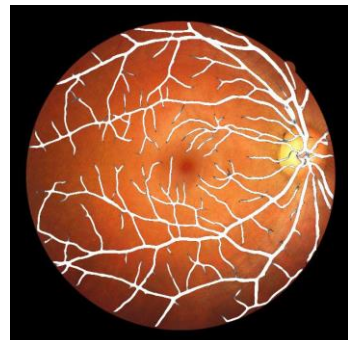

Figure 7: Image of the retina with removed blood vessels.

5. Conclusions

The current challenge is early and automated diagnosis and prognosis of glaucoma using information technology based on machine and deep learning methods.

The aim of this study is to develop the information technology for diagnosis and prognosis of glaucoma based on machine learning methods, which will have minimal requirements and resource needs, be characterized by low cost and mass use, and will not require an ophthalmologist to decipher the data generated by the neural network.

The proposed information technology for diagnosis and prognosis of glaucoma based on machine learning methods automates the processing of fundus retinal images and optical coherence tomography images based on machine learning in order to automatically diagnose glaucoma at early stages by classifying the eye as normal or glaucomatous.

The task of the authors' future research will be to form and study a larger and better dataset, improve the quality and accuracy of image preprocessing and classification.

References

- [1] J. B. Jonas, T. Aung, R. R. Bourne, A. M. Bron, R. Ritch, S. Panda-Jonas, Glaucoma, *Lancet* 390.10108 (2017) 2183–2193. doi:10.1016/s0140-6736(17)31469-1.
- [2] K. Allison, D. Patel, O. Alabi, Epidemiology of Glaucoma: The Past, Present, and Predictions for the Future, *Cureus* (2020). doi:10.7759/cureus.11686.
- [3] Y.-C. Tham, X. Li, T. Y. Wong, H. A. Quigley, T. Aung, C.-Y. Cheng, Global Prevalence of Glaucoma and Projections of Glaucoma Burden through 2040, *Ophthalmology* 121.11 (2014) 2081–2090. doi:10.1016/j.ophtha.2014.05.013.
- [4] X. Huang, M. R. Islam, S. Akter, F. Ahmed, E. Kazami, H. A. Serhan, A. Abd-alrazaq, S. Yousefi, Artificial intelligence in glaucoma: opportunities, challenges, and future directions, *Biomed. Eng. OnLine* 22.1 (2023). doi:10.1186/s12938-023-01187-8.
- [5] A. Rafay, Z. Asghar, H. Manzoor, W. Hussain, EyeCNN: exploring the potential of convolutional neural networks for identification of multiple eye diseases through retinal imagery, *Int. Ophthalmol.* (2023). doi:10.1007/s10792-023-02764-5.

- [6] T. Hovorushchenko, A. Herts, Ye. Hnatchuk, Concept of Intelligent Decision Support System in the Legal Regulation of the Surrogate Motherhood. CEUR-WS 2488 (2019) 57-68.
- [7] T. Hovorushchenko, O. Pomorova, Evaluation of mutual influences of software quality characteristics based ISO 25010:2011, in: Proceedings of 2016 XIth International Scientific and Technical Conference "Computer Sciences and Information Technologies (CSIT), IEEE, 2016. doi:10.1109/stc-csit.2016.7589874.
- [8] T. Hovorushchenko, Ye. Hnatchuk, A. Herts, O. Onyshko. Intelligent Information Technology for Supporting the Medical Decision-Making Considering the Legal Basis. CEUR-WS 2853 (2021) 72-82.
- [9] T. Hovorushchenko, A. Moskalenko, V. Osyadlyi, Methods of medical data management based on blockchain technologies, J. Reliab. Intell. Environ. 9.1 (2022) 5-16. doi:10.1007/s40860-022-00178-1.
- [10] T. Hovorushchenko, A. Herts, Y. Hnatchuk, O. Sachenko, Supporting the Decision-Making About the Possibility of Donation and Transplantation Based on Civil Law Grounds, in: Advances in Intelligent Systems and Computing, Springer International Publishing, Cham, 2020, p. 357–376. doi:10.1007/978-3-030-54215-3_23.
- [11] N. Boiko, R. Kovalchuk, Data Update Algorithms in the Machine Learning System, Comput. Syst. Inf. Technol. № 1 (2023) 6–13. doi:10.31891/csit-2023-1-1.
- [12] J. C. Mathew, V. Ilango, V. Asha, Machine Learning Techniques, Detection and Prediction of Glaucoma– A Systematic Review, Int. J. Recent Innov. Trends Comput. Commun. 11.5s (2023) 283–309. doi:10.17762/ijritcc.v11i5s.6655.
- [13] R. Asaoka, H. Murata, K. Hirasawa, Y. Fujino, M. Matsuura, A. Miki, T. Kanamoto, Y. Ikeda, K. Mori, A. Iwase, та ін., Using Deep Learning and Transfer Learning to Accurately Diagnose Early-Onset Glaucoma from Macular Optical Coherence Tomography Images, Am. J. Ophthalmol. 198 (2019) 136–145. doi:10.1016/j.ajo.2018.10.007.
- [14] A. Gutierrez, T. C. Chen, Artificial intelligence in glaucoma: posterior segment optical coherence tomography, Curr. Opin. Ophthalmol. Publish Ahead of Print (2022). doi:10.1097/icu.0000000000000934.
- [15] M. Y. S. Ali, M. Jabreel, A. Valls, M. Baget, M. Abdel-Nasser, Glaucoma Detection in Retinal Fundus Images Based on Deep Transfer Learning and Fuzzy Aggregation Operators, Int. J. Artif. Intell. Tools (2022). doi:10.1142/s0218213023400018.
- [16] V. R. Naramala, B. A. Kumar, V. S. Rao, A. Mishra, S. A. Hannan, Y. A. B. El-Ebiary, R. Manikandan, Enhancing Diabetic Retinopathy Detection Through Machine Learning with Restricted Boltzmann Machines, Int. J. Adv. Comput. Sci. Appl. 14.9 (2023). doi:10.14569/ijacsa.2023.0140961.
- [17] K. Lamba, S. Rani, Machine Learning based Segmentation and Classification Algorithms for Glaucoma Detection, in: Proceedings of 2023 International Conference on Sustainable Computing and Smart Systems (ICSCSS), IEEE, 2023. doi:10.1109/icscss57650.2023.10169226.
- [18] J. Manikandan, R. M. Sidharth, R. Yogeshkumar, V. C. Sasi. Glaucoma Disease Detection Using Hybrid Deep Learning Model, in: Proceedings of 2023 Eighth International Conference on Science Technology Engineering and Mathematics (ICONSTEM), IEEE, 2023. doi:10.1109/iconstem56934.2023.10142668.

- [19] R. Thamilselvan, P. Natesan, R. R. Rajalaxmi, S. Mohan, S. Muruganantham, R. Vanitha, An Elaborate Review of Diagnosing Glaucoma Disease Using Machine Learning and Deep Learning Techniques, in: Proceedings of 2023 International Conference on Computer Communication and Informatics (ICCCI), IEEE, 2023. doi:10.1109/iccci56745.2023.10128598.
- [20] A. Venkatanand ram, B. Methari, A Novel Approach Toward Detection of Glaucoma Using Machine Learning Techniques, in: Lecture Notes in Electrical Engineering, Springer Nature Singapore, Singapore, 2023, p. 295–302. doi:10.1007/978-981-99-0189-0_21.
- [21] L. K. Singh, Pooja, H. Garg, M. Khanna, An IoT based predictive modeling for Glaucoma detection in optical coherence tomography images using hybrid genetic algorithm, Multimedia Tools Appl. (2022). doi:10.1007/s11042-022-13540-5.
- [22] M. Juneja, J. S. Minhas, N. Singla, S. Thakur, N. Thakur, P. Jindal, Fused framework for glaucoma diagnosis using Optical Coherence Tomography (OCT) images, Expert Syst. With Appl. 201 (2022) 117202. doi:10.1016/j.eswa.2022.117202.
- [23] P. Ramesh, T. Subramaniam, P. Ray, A. Devadas, S. Ramesh, S. Ansar, M. Ramesh, R. Rajasekaran, S. Parthasarathi, Utilizing human intelligence in artificial intelligence for detecting glaucomatous fundus images using human-in-the-loop machine learning, Indian J. Ophthalmol. 70.4 (2022) 1131. doi:10.4103/ijo.ijo_2583_21.
- [24] D. Shamia, S. Prince, D. Bini, An Online Platform for Early Eye Disease Detection using Deep Convolutional Neural Networks, in: Proceedings of 2022 6th International Conference on Devices, Circuits and Systems (ICDCS), IEEE, 2022. doi:10.1109/icdcs54290.2022.9780765.
- [25] C.-W. Wu, H.-L. Shen, C.-J. Lu, S.-H. Chen, H.-Y. Chen, Comparison of Different Machine Learning Classifiers for Glaucoma Diagnosis Based on Spectralis OCT, Diagnostics 11.9 (2021) 1718. doi:10.3390/diagnostics11091718.
- [26] K. C. Pathak, R. B. Shah, R. R. Tharakan, B. N. Patel, D. C. Jariwala, Diabetic Retinopathy Diagnosis and Categorization using Deep Learning - A Review, in: Proceedings of 2021 5th International Conference on Intelligent Computing and Control Systems (ICICCS), IEEE, 2021. doi:10.1109/iciccs51141.2021.9432312.
- [27] N. Patil, P. N. Patil, P. V. Rao, Convolution neural network and deep-belief network (DBN) based automatic detection and diagnosis of Glaucoma, Multimedia Tools Appl. 80.19 (2021) 29481–29495. doi:10.1007/s11042-021-11087-5.
- [28] S. Krishnan, J. Amudha, S. Tejwani, Intelligent-based decision support system for diagnosing glaucoma in primary eyecare centers using eye tracker, J. Intell. & Fuzzy Syst. (2021) 1–8. doi:10.3233/jifs-189846.
- [29] M. Antony Ammal, D. Gladis, A. Shaik, Metric Measures of Optic Nerve Head in Screening Glaucoma with Machine Learning, in: Advances in Intelligent Systems and Computing, Springer Singapore, Singapore, 2021, c. 583–599. doi:10.1007/978-981-33-4389-4_54.
- [30] M. H. Sarhan, M. A. Nasser, D. Zapp, M. Maier, C. Lohmann, N. Navab, A. Eslami, Machine Learning Techniques for Ophthalmic Data Processing: A Review, IEEE J. Biomed. Health Inform. (2020) 1. doi:10.1109/jbhi.2020.3012134.